

SendPro® Desktop SendKit

Installation Instruction

USB Printer Connection

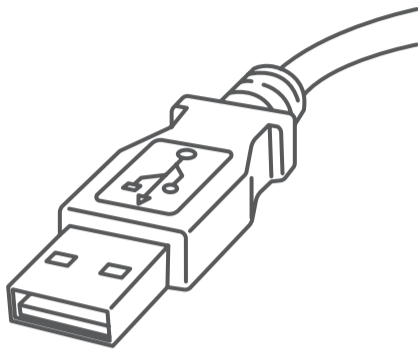

Read Now BEFORE you unpack your equipment

Continue reading below



Let's get your SendKit up and running quickly...

Let's first get together the things you will need:

- The box containing your SendPro® Desktop SendKit.
- A Welcome Email from Pitney Bowes containing your SendPro® Login details.
- A PC on which you have full admin rights to allow downloading and installing software, if necessary.
- 2 available USB ports on your PC.

If you have not received the email from Pitney Bowes, do not go any further with this installation. Please visit pitneybowes.com for contact details for your market.

1. Opening the box and unpacking.

Here's a diagram and explanation of the items you should find in your box.

Scale

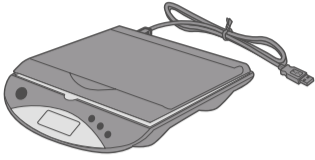

Printer

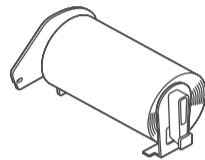
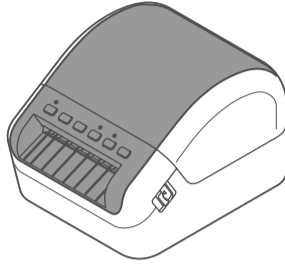

DK Starter Roll

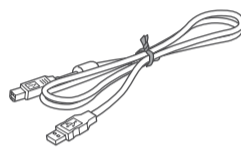

USB



Power Cord

Printer control panel buttons

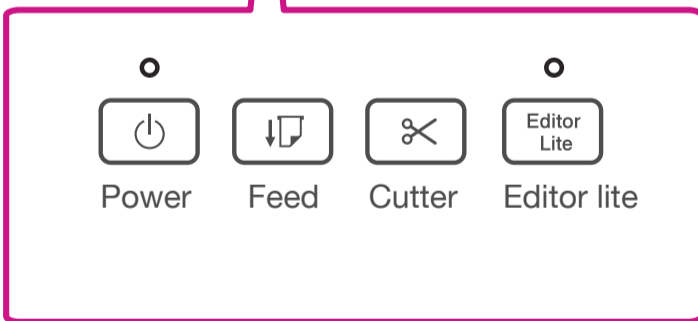
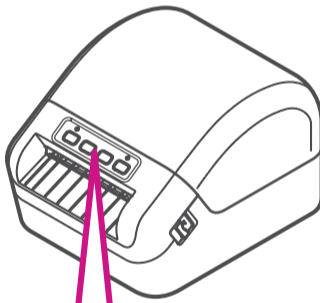

2. Signing into SendPro®.

Sign into SendPro® using the link in the welcome email.

sendpro.pitneybowes.com



3. Downloading the scale utility for Windows OS only.

1. Now you are signed into SendPro® Click on the Help icon. 
2. Select **Download SendPro® Scale Utility for Windows.**
3. Select **Run** or **Open** (this depends on your internet browser).
4. Follow the prompts on screen to install.
5. Click **Finish.**



4. Connecting your scale.

Place your scale on a firm and flat surface near to your computer.

Connect your scale to your computer using the USB cable supplied. Then press the **Zero** button.

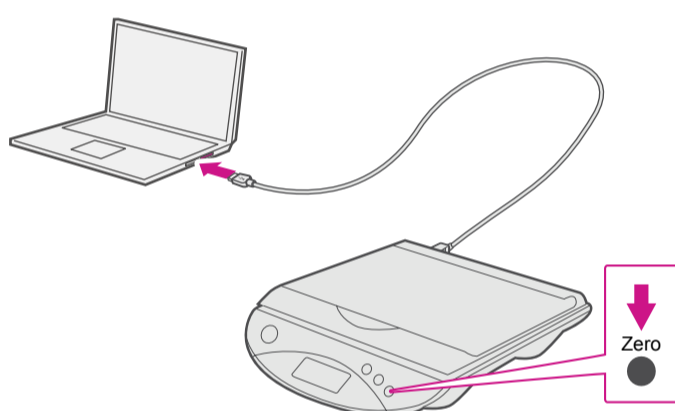

5. Connecting the printer.

Connect the power cord to your printer (as shown). Make sure the printer is still turned off.

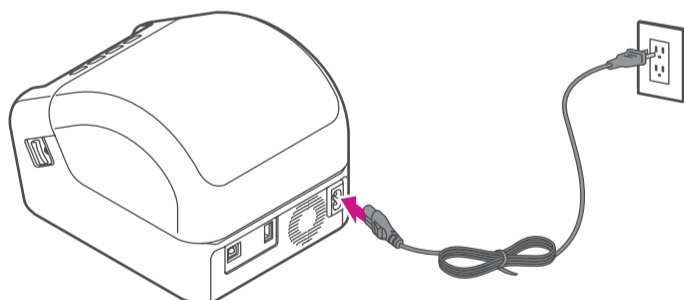

6. Loading the DK roll.

1. Pull the release levers on the both sides of the printer to unlock the cover, and lift the cover to open it.

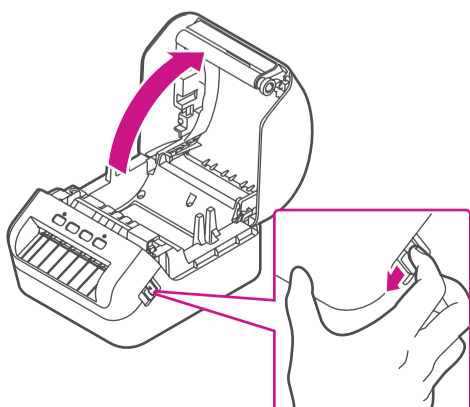

2. Remove the protective sheet from the output slot.

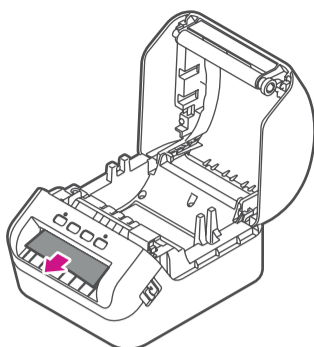

3. Place the DK roll into the guide.

Make sure the roll is inserted firmly in the guide and the stabilizer slides into the notch in the printer

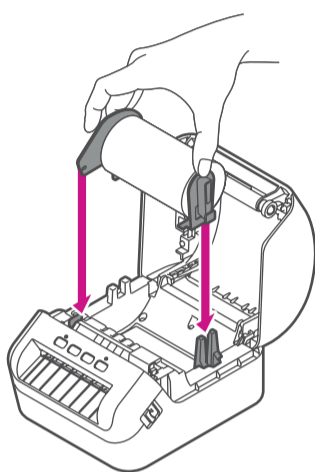

4. Thread the DK roll through the printer.

Align the edge of the DK roll with the upright edge of the output slot.

Check that the DK roll is threaded straight.

Push the first label through the output slot until the end comes out of the slot as shown.

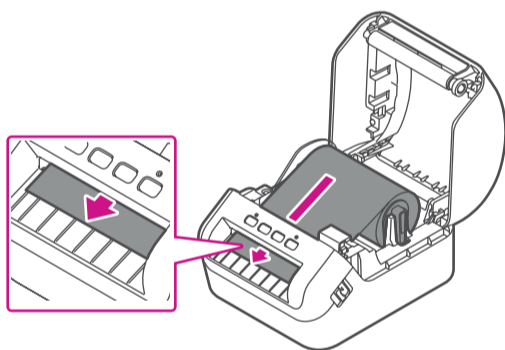

If experiencing trouble loading the label roll, try inserting from the side making sure the label is under the sensor.

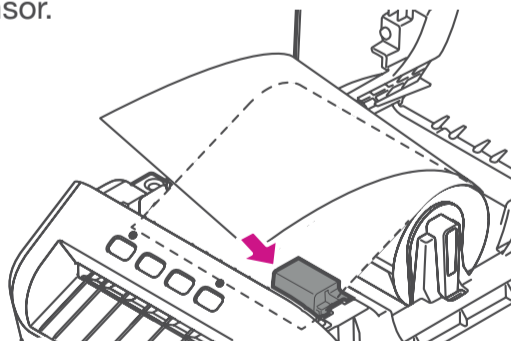

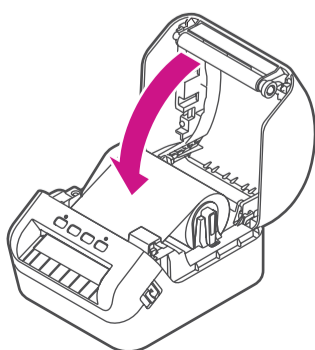

5. Close the cover.

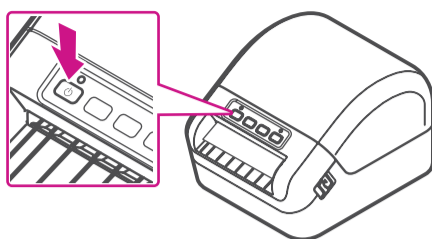

7. Turn power on.

Press the power button  to turn the printer on, and check the status LED turns green.



Make sure to press the feed button  to align the end of the DK Roll.

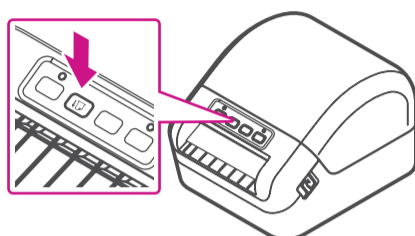

8. Install QL-1100 printer drivers on a computer.

1. Visit URL install.brother to download the Software/ Documentation Installer for the latest drivers, software and manuals. Accept the agreement and click Download.
2. Double-click the downloaded EXE file (for Windows) or DMG file (for Mac), and follow the on-screen instructions to proceed with the installation.

Note: You may need to check your downloads folder to install the downloaded file.

3. Close the dialog box when the installation is complete.



Now let's get shipping!

You can access in-depth Online Help that covers all operator and feature aspects of your SendPro® software and SendKit in detail. To access this information, press the Help (🔍) icon from your App. and select **See More Help Topics**. But for your convenience, we've included links to most commonly needed support to get you started.

How to create a shipping label in SendPro

[Click Here](#)

How to print a shipping label in SendPro

[Click Here](#)

How to invite additional users in SendPro

[Click Here](#)

How to export a History report in SendPro

[Click Here](#)

Carrier Services and Packaging

For information about size and weight restrictions, visit the carrier's website:

[Canada Post](#)

[UPS](#)

[FedEx](#)

Note: Available carriers dependent on Sendpro subscription.

How to change your username, password, and account name for SendPro

[Click Here](#)

Troubleshooting

Printing Issues

Labels printing too small

If your labels are printing too small, the wrong paper size may be selected. To correct this:

Select Settings icon  then Label Options.

If the Choose Format menu is set to Plain Paper - 8.5 x 11, select Roll - 4 x 6.

Note: If Plain Paper - 8.5 x 11 is always selected by default, you can change this to 4 x 6 by adjusting your default label printing settings.

Problem

Solution

The Status LED is not lit.

- Check that the AC Power Cord is inserted. If it is inserted correctly, try plugging it into another AC power outlet.

The Printer does not print, or a printing error is received.

- Check that the USB Cable is connected securely.
- Remove the DK Roll and reinsert it.
- Check that there is enough roll remaining.
- Make sure that the DK Roll Cover is closed.
- Turn off the Printer and then turn it on again. If there is still a problem, contact Pitney Bowes support.
- If the Printer is connected via a USB hub, try connecting it directly to the computer. If not, try connecting it to a different USB Port.

A data transmission error appears on the computer.

- Check that the correct port is selected from the "Print to the following port" list in the Printer Properties dialog box.
- Wait until the Status LED stops flashing and then try printing again.

The label is not ejected correctly after printing.

- Check that the Label Output Slot is not blocked.
- Check that the DK Roll is set correctly by removing the DK Roll and reinstalling it.
- Ensure that the DK Roll Cover is closed correctly.

Labels are jammed in the cutter.

- Contact Pitney Bowes Customer Service.

Cutter error

- If a cutter error occurs, keep the DK Roll Cover closed and press the Power Button. The cutter moves back to the normal position and the Printer turns off automatically. After the Printer is Off, check the Label Output Slot and remove any jammed labels.

Unable to reset an error.

- To reset an error:
1. Open the DK Roll Cover, and then close it.
 2. If the error is not reset, press the Cutter Button.
 3. If the error is not reset, turn off the Printer, and then turn it on again.
 4. If the error is not reset, contact Pitney Bowes Customer Service.
-

Scale Issues

If the scale icon is grayed out and cannot be selected, or if the scale icon can be selected, but does not update to reflect the weight from the scale, this indicates that:

- The scale app has not been installed.
- There is nothing on the scale.
- There is a USB hub between the scale and the computer.

Ensure that the compatible scale is installed:

10lb/5Kg USB scale

Ensure that the scale app is installed. For details, see [Install the Scale](#).

If the scale icon is grayed out, place an item on the scale. The scale icon should then display the weight of the item on the scale.

Ensure that the USB cable is connected directly from the scale to the computer.

Do not use a USB hub between the USB scale and the computer.

Note: When the scale is connected to a computer with the USB cable, the power button on the scale will be disabled. The power button is only used when the scale is powered with a 9-volt battery. There is no need to use a battery if the scale is connected to the computer with a USB cable.

If you're still having trouble, then visit
www.pitneybowes.com/ca/en/desktopsendkit
and select Support.



AW32810REVA

AW32810 Rev. A 12/18
©2018 Pitney Bowes Inc.
All Rights Reserved

pitney bowes 

5500 Explorer Drive
Mississauga, ON L4W 5C7
www.pitneybowes.com/ca/en