

ComColor FW Series

5230/5230R/5231/5231R/5000/5000R

This guide describes total operation features and specifications.

User's Guide

Functions vary depending on the model.

	ComColor FW5230/FW5230R	ComColor FW5231/FW5231R	ComColor FW5000/FW5000R
Maximum Print Area	310 mm × 544 mm (12 3/16" × 21 13/32")	310 mm × 544 mm (12 3/16" × 21 13/32")	210 mm × 544 mm (8 1/4" × 21 13/32")
Feed Tray	✓	N/A*	✓
Color Support	Full color (Cyan, Magenta, Yellow, Black)	Full color (Cyan, Magenta, Yellow, Black)	Full color (Cyan, Magenta, Yellow, Black)

✓: available

N/A: not available

* [Mixed Size Original], [Add Cover], [Slip Sheet], [Paper Tray Relay] in Copy mode, Print mode, and Storage mode are not available.

The [Mixed size original] function in Scan mode is available only for reading.



CAUTION

After reading this guide, keep it in handy for future reference. The "Safety Precautions" are provided in the supplemental Safety Information. Be sure to read through them prior to use.

About This Guide

Preface

Thank you for using a ComColor FW Series product.

This ComColor FW Series product is a network-compatible inkjet printer that performs high-speed, color printing. This machine is equipped with a variety of functions designed to meet various customer needs, such as the ability to print the data and monitor printer operations from a computer.

In addition, using the machine with the optional scanner provides additional functions such as the ability to copy originals, and save and use the scanned data.

The five guides described below are supplied with this machine.

- **Quick Guide**

This guide describes basic machine operations and how to replace consumables.

Keep this guide handy, such as near the machine, for easy reference.

Start by reading this guide.

- **User's Guide (this guide)**

This guide describes handling precautions and specifications, as well as the operations and settings of each function.

Read this guide for a more detailed understanding of the machine.

- **Administrator's Guide**

This guide describes the machine settings and optional equipment (IC card reader, scanner, etc.) to be configured by the administrator.

- **Troubleshooting Guide**

This guide describes the actions to take when a paper jam or other problem occurs.

- **Safety Information**

This guide describes safety precautions and specifications.

About This Guide

(1) This guide may not be reproduced in whole or in part without the permission of RISO KAGAKU CORPORATION.

(2) The contents of this manual may be changed without prior notice due to product improvements.

(3) RISO KAGAKU CORPORATION shall not be liable for any consequence of using this guide or the machine.

Trademark Credits

Microsoft and Windows are the trademarks or registered trademarks of Microsoft Corporation in the U.S., Japan, and/or other countries.

Mac, Mac OS, OS X, and Safari are the trademarks of Apple Inc.

Adobe, the Adobe logo, and PostScript are the trademarks or registered trademarks of Adobe Systems Incorporated in the U.S. and other countries.

ColorSet is a trademark of Monotype Imaging Inc. registered in the U.S. Patent & Trademark Office and may be registered in certain jurisdictions.

FeliCa is a registered trademark of Sony Corporation.

Mifare is a registered trademark of Royal Philips Electronics.

 RISO, ComColor, and FORCEJET are trademarks or registered trademarks of RISO KAGAKU CORPORATION in the United States and other countries.

All other product names and company names in this document are the trademarks or registered trademarks of their respective companies.



Acquisition of Color Universal Design Certification

The ComColor FW5230/FW5230R/FW5231/FW5231R/FW5000/FW5000R (machine and option*) are recognized by the incorporated non-profit organization Color Universal Design Organization (CUDO) in achieving Color Universal Design.

* Certified optional equipment
Scanner/Face down finisher

Symbols, Notations, and Screenshots Used in This Guide

■ Symbols Used in This Guide



Indicates cautions that should be noted for safe use of this machine.



Indicates important items that should be noted or are prohibited.



Indicates useful or additional information.

■ Names of Keys and Buttons

The names of hard keys on the operation panel and buttons on the touch panel screen or computer window are indicated with square brackets [].

● Operation Panel

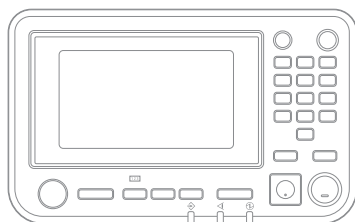

Example: Press the [Stop] key.

● Touch Panel Screen

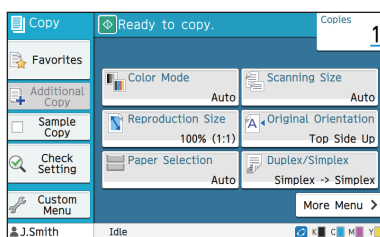

Example: Touch [Color Mode].

● Computer Window

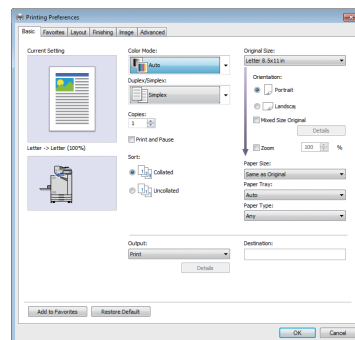

Example: Select the [Mixed Size Original] check box.

■ Names of Optional Equipment

In this guide, the names of the optional equipment are described using a generic term as shown below. The specific name for each item of equipment is used when its unique features are explained.

Name Used in This Guide	Optional Equipment
Stacking tray*	Wide stacking tray Auto-control stacking tray

* Optional stacking tray connected to the right side of the machine.

■ Illustrations and Operating Procedures in This Guide

- The operating procedures, screenshots, and illustrations in this guide are for the ComColor FW5230/FW5230R with the optional scanner connected. This guide also assumes that each function is set to the factory setting, and that [Login Setting] is set to [ON].
- The screenshots and illustrations in this guide may vary depending on the machine model and usage environment, including the connected optional equipment.

Functions Made Possible by Installing Optional Equipment

A variety of optional equipment is available to expand the functionality of this machine. The list below shows the optional equipment that is required to expand each function.

Function to Expand	Optional Equipment Required
Staple	Face down finisher
Offset output	Face down finisher
Output tray selection	Auto-control stacking tray or wide stacking tray
Automatic switching of output tray (output tray relay)	Auto-control stacking tray
Login with authentication card	IC card authentication kit
Printing with PostScript 3 printer driver	PostScript kit
Printing PDF files saved on USB flash drive	PostScript kit
Printing from OS X	PostScript kit
Printing from tablet or smartphone using RISO PRINT-S application	PostScript kit

What You Can Do With This Machine

Conserve paper when printing

**Duplex/Simplex (p. 1-10, p. 3-9),
Combine (p. 1-13, p. 3-15)**

You can print on both sides of the paper or print multiple pages on a single sheet. You can also use duplex printing in conjunction with the combine function.

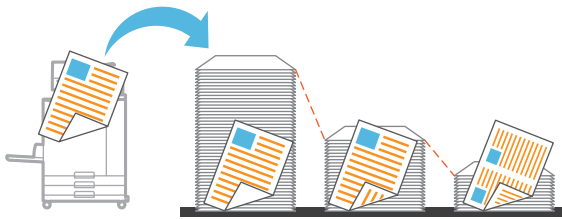

Quickly sort large amounts of documents

**Sort (p. 1-10, p. 3-10) Separation,
Slip Sheet (p. 1-21, p. 3-20)**

You can use the sort or slip sheet function to quickly separate a large amount of meeting documents or handouts. You can increase efficiency even more with offset output, which is available when using the optional face down finisher.

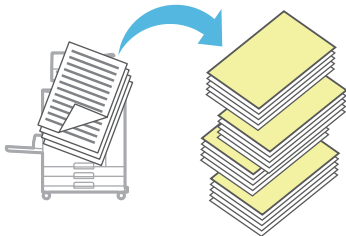

Register and retrieve settings

Favorites (p. 1-24, p. 2-10, p. 3-14, p. 4-6, p. 5-6)

You can add settings as favorites, and quickly retrieve them when desired. This eliminates the need to configure the same settings each time.

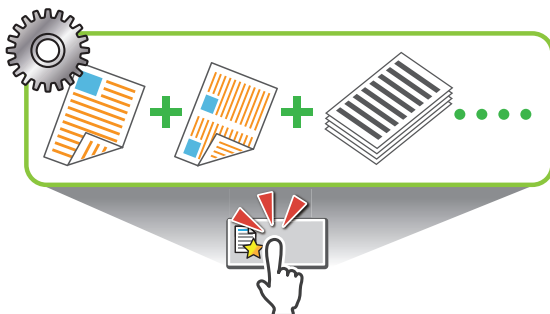

Check the results before printing large amounts

Sample Copy (p. 1-25), Print and Pause (p. 3-10)

You can print one sample and check the results and settings.



Print clearly on envelopes

Envelope Imaging (p. 3-24)

You can print on envelopes of various thicknesses with less blurring and smudging.



Prioritize communication speed when printing

Data Compression (p. 3-21)

You can reduce the size of your print file and prioritize network communication speed over image quality when you print.

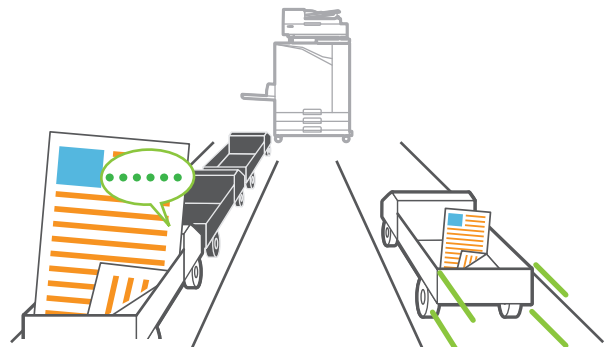

Save your frequently printed documents on the printer

Storage (p. 4-1)

By saving documents in a folder, you can quickly print them when needed. You can also share folders.



Protect documents with a PIN code

PIN Code (p. 2-9, p. 3-24)

When you assign a PIN code to a job, only the person who knows the PIN code can print it. You can also assign a PIN code to documents read by the scanner.

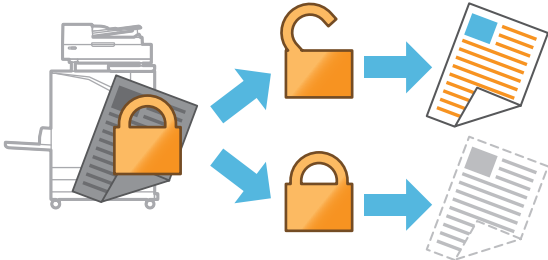

Check the printer status from a computer

RISO Console (p. 6-1)

Check the machine's status and settings from your computer, and perform job operations without having to actually go to the machine.



Save power consumption during standby

Power Saving Setting (p. 25)

You can save power by reducing the power consumption during standby. You can set the amount of time until the machine enters power save mode, enters the sleep state, or turns the backlight OFF, and you can select the amount of power that the machine consumes while in the sleep state.

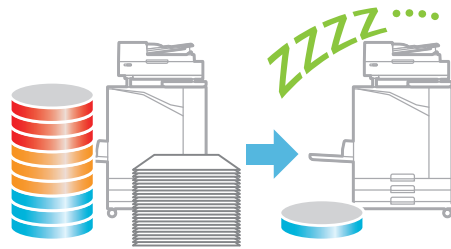

Print on non-standard size paper with ease

Paper Selection (p. 1-7, p. 3-30), Scanning Size (p. 1-9), Paper Size (p. 3-11)

When using a non-standard paper size that is not registered in the printer, you can still print in the same way as with standard size paper.



Process originals of various sizes together at the same time

Mixed Size Original (p. 1-11, p. 2-8, p. 3-11)

The machine automatically recognizes the size of originals when copying and scanning, even when you load originals of various sizes.



Contents

About This Guide	1
Symbols, Notations, and Screenshots Used in This Guide	2
Functions Made Possible by Installing Optional Equipment	3
What You Can Do With This Machine	4
Part Names and Functions	12
Main Unit and Optional Scanner	12
Operation Panel	14
Touch Panel	15
[Home] Screen	15
Mode Screens	16
Touch Panel	23
Preparation	25
Power	25
Login	26
Loading Paper	26
Closing the Standard Tray	29
Installing the Printer Driver	30
Operating Environment	30
Installing	30
About Jobs	31
[Active / Idle] Screen	31
[Finished] Screen	32
Chapter 1 Copy.....	1-1
Overview of Copy Operations	1-2
Procedure	1-2
List of Settings	1-5
Copy Settings	1-7
Color Mode	1-7
Reproduction Size	1-7
Paper Selection	1-7
Scanning Size	1-9
Original Orientation	1-9
Duplex / Simplex	1-10
Sort	1-10
Scanning Level	1-10

Print Density	1-10
ADF Scan & Pause	1-11
Mixed Size Original	1-11
Book Shadow Erasure	1-12
Page Split	1-12
Combine	1-13
Image Repeat	1-13
Booklet	1-14
Stamp	1-14
Page Border	1-16
Image Quality	1-16
Original Type	1-16
Gamma Correction	1-17
Image Control	1-17
Base Color Level	1-18
Image Position	1-18
Program	1-18
Add Cover	1-20
Separation	1-21
Binding Margin	1-22
Staple	1-22
Slow Printing	1-22
Output Tray	1-22
Output Tray Relay	1-22
Paper Tray Relay	1-22
Auto Image Rotation	1-22
Interrupt Copy	1-23
Copy Mode Function Buttons	1-24
Favorites	1-24
Additional Copy	1-24
Sample Copy	1-25
Check Setting	1-25
Custom Menu	1-25

Chapter 2 Scanning **2-1**

Overview of Scan Operations **2-2**

Procedure	2-2
List of Settings	2-5

Scan Settings **2-6**

Document Name	2-6
Color Mode	2-7
Scanning Size	2-7
File Format	2-7

Duplex / Simplex	2-8
Scanning Level	2-8
Original Orientation	2-8
Resolution	2-8
Mixed Size Original	2-8
Book Shadow Erasure	2-8
Page Split	2-8
PIN Code	2-9
Original Type	2-9
Gamma Correction	2-9
Image Control	2-9
Base Color Level	2-9
Scan Mode Function Buttons	2-10
Favorites	2-10
Check Setting	2-10
Custom Menu	2-10

Chapter 3 Print **3-1**

Overview of Print Operations **3-2**

Procedure From the Printer Driver	3-2
Procedure From Print Mode	3-3
Printer Driver Screen	3-5
List of Settings	3-6

Printer Driver Settings **3-9**

[Basic] Tab	3-9
[Favorites] Tab	3-14
[Layout] Tab	3-15
[Finishing] Tab	3-19
[Image] Tab	3-21
[Advanced] Tab	3-24
Environment Settings	3-26
[Environment] Tab	3-26

Print Mode Function Buttons **3-29**

Online / Offline	3-29
External System Job	3-29
Details	3-30
Change Setting	3-30

Chapter 4 Storage **4-1**

Overview of Storage Operations **4-2**

Saving the Data to a Folder	4-2
-----------------------------------	-----

Printing a Document in a Folder	4-3
List of Settings in [Storage] - [Save]	4-4
List of Settings in [Storage] - [Load]	4-5
Storage Mode Function Buttons	4-6
Function Buttons in [Storage] - [Save]	4-6
Function Buttons in [Storage] - [Load]	4-7
Chapter 5 USB	5-1
Overview of USB Operations	5-2
Saving the Scanned Data to a USB Flash Drive	5-2
Printing a Document Saved on a USB Flash Drive	5-3
List of Settings in [USB] - [Save]	5-4
List of Settings in [USB] - [Load]	5-5
USB Mode Function Buttons	5-6
Function Buttons in [USB] - [Save]	5-6
Function Buttons in [USB] - [Load]	5-6
Chapter 6 RISO Console	6-1
Overview of the RISO Console	6-2
Top Screen	6-2
Starting the RISO Console	6-3
Common Button Operations	6-4
[System Info] Menu	6-6
[Consumables] Screen	6-6
[Machine Info] Screen	6-6
[User Info] Screen	6-7
[License Info] Screen	6-8
[Scan] Menu	6-9
[Scan] Menu Screen	6-9
[Print] Menu	6-10
[Print] Menu Screen	6-10
[Storage] Menu	6-11
[Load] Screen	6-11
[Job Status] Menu	6-12
[Active / Idle] Screen	6-12
[Finished] Screen	6-12
[Maintenance] Menu	6-13
[Maintenance] Menu Screen	6-13

Chapter 7	Using the Barcode Area Definition Software	7-1
	Overview of the Barcode Area Definition Software	7-2
	Installing the Barcode Area Definition Software	7-2
	Starting the Barcode Area Definition Software	7-3
	Main Screen	7-3
	Creating and Registering a Barcode Area Definition File	7-5
	Procedure	7-5
	Repetition Function	7-8
	Printing Barcode Originals	7-8
Chapter 8	Optional Equipment	8-1
	Face Down Finisher	8-2
	List of Settings	8-3
	Printer Driver Settings	8-3
	Copy Mode Settings	8-6
	Stacking Tray (Auto-control Stacking Tray / Wide Stacking Tray) ...	8-8
	Loading the Stacking Tray	8-8
	List of Settings	8-10
	Printer Driver Settings	8-11
	Copy Mode Settings	8-11
	Maintenance Mode Settings	8-11
	PostScript Kit	8-12
	Operating Environment	8-12
	Installing to Windows	8-12
	Installing to OS X	8-13
	Installing to Linux	8-14
	How to Print	8-14
	Printer Driver Settings	8-15
	[Basic] Tab	8-15
	[Favorites] Tab	8-16
	[Layout] Tab	8-16
	[Finishing] Tab	8-16
	[Image] Tab	8-17
	[Advanced] Tab	8-18
	[Environment] Tab	8-21
	RISO Console Settings	8-22
	Printable Files in the USB Flash Drive	8-22
	Font List	8-24

Chapter 9 Appendix9-1

- About Ink Cartridges9-2**
 - Ink Cartridge Replacement 9-2
- Specifications9-3**
- Consumables9-12**
 - Ink Cartridges 9-12
 - Staple Cartridge 9-12
- Index9-13**

Part Names and Functions

Main Unit and Optional Scanner

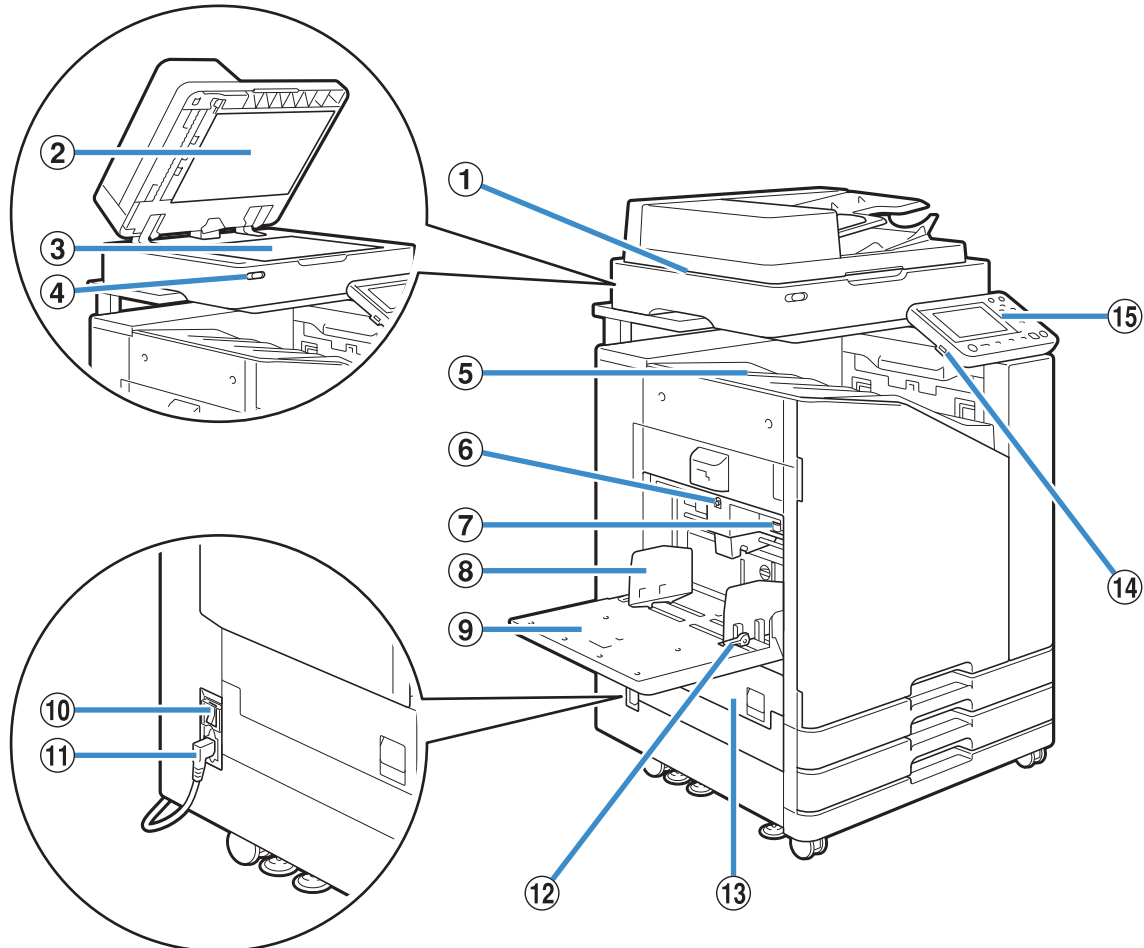

① Scanner (Optional)

Use the scanner to copy or scan documents that are read from the platen glass or the ADF.

② Original Cover

Pull down to cover the original when reading it on the platen glass.

③ Platen Glass

Set the original face down and aligned with the position of the arrow in the top left.

④ Scanner Lamp (Blue / Red)

This lamp indicates the status of the scanner.

- Blue lamp ON: Ready
- Blue lamp flashing: Machine is starting up or scanning
- Red lamp flashing: Error has occurred

⑤ Face Down Tray

Printouts are output face down.

⑥ Standard Tray Descent Button

Use this button to move the standard tray up or down when replacing or adding paper to it.

⑦ Paper Feed Pressure Adjustment Lever

Use this lever to adjust the paper feed pressure to suit the paper type in the standard tray.

⑧ Standard Tray Paper Guide

This guide prevents paper in the standard tray from becoming misaligned.

⑨ Standard Tray

Load special paper (thick paper, envelopes, etc.) here. You can also load plain paper.

⑩ Main Power Switch

Use this switch to turn on the power. Usually the power is left ON.

⑪ Main Unit Socket

Connect the main unit power cable to this socket.

⑫ Paper Feed Guide Lever

Use this lever to slide or fix the standard tray paper guide. Levers are located on both sides of the standard tray paper guide, in two places.

⑬ Left Cover

Open this cover when there is a paper jam.

⑭ USB Port

Connect a USB flash drive to this port to save the scanned data or to print the data saved on a USB flash drive.



- Use USB flash drives compatible with Mass Storage Class and USB 2.0 or 3.0 specifications.

⑮ Operation Panel

Use to perform operations or settings.

You can adjust the angle so that it is easier to see.

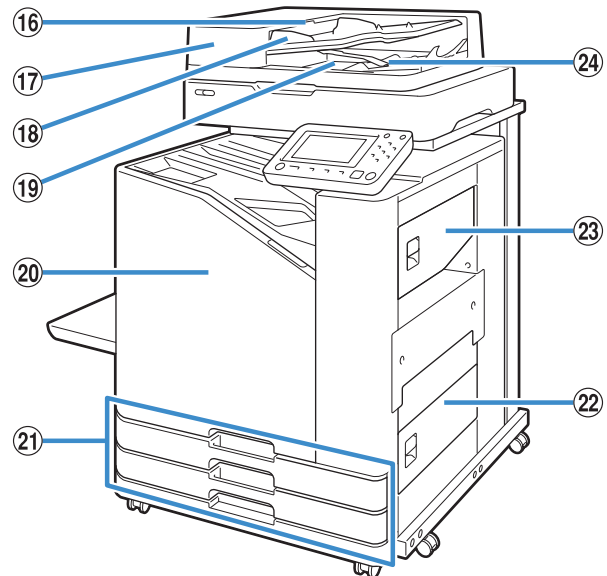

⑯ ADF Original Unit Lever

Pull this lever up to open the ADF original unit cover when documents are jammed.

⑰ Auto Document Feeder (ADF)

Up to about 200 documents can be automatically fed.

⑱ ADF Original Guide

Slide to fit the width of the document.

⑲ ADF Original Output Tray

Documents that are read from the ADF are output here.

⑳ Front Cover

Normally the front cover is locked and cannot be opened. This lock is automatically released when a paper jam or other problems occur.

To open the front cover in other cases, go to [Maintenance] from the [Home] screen and touch [Front Cover Release].

㉑ Feed Tray 1, Feed Tray 2 (Feed Trays)

Load the paper to be used for printing here.



- Use the standard tray for thick paper and other special paper types.

㉒ Lower Right Cover

Open this cover when there is a paper jam.

㉓ Upper Right Cover

Open this cover when there is a paper jam.

㉔ Paper Alignment Lever

Use this lever to align the documents that are output. If the lever interferes with output, pull it up and lock it.

Operation Panel

Various operations and settings can be performed using the operation panel.

The color and condition (light up or flashing) of the lamps indicate the machine status or errors such as paper jams.

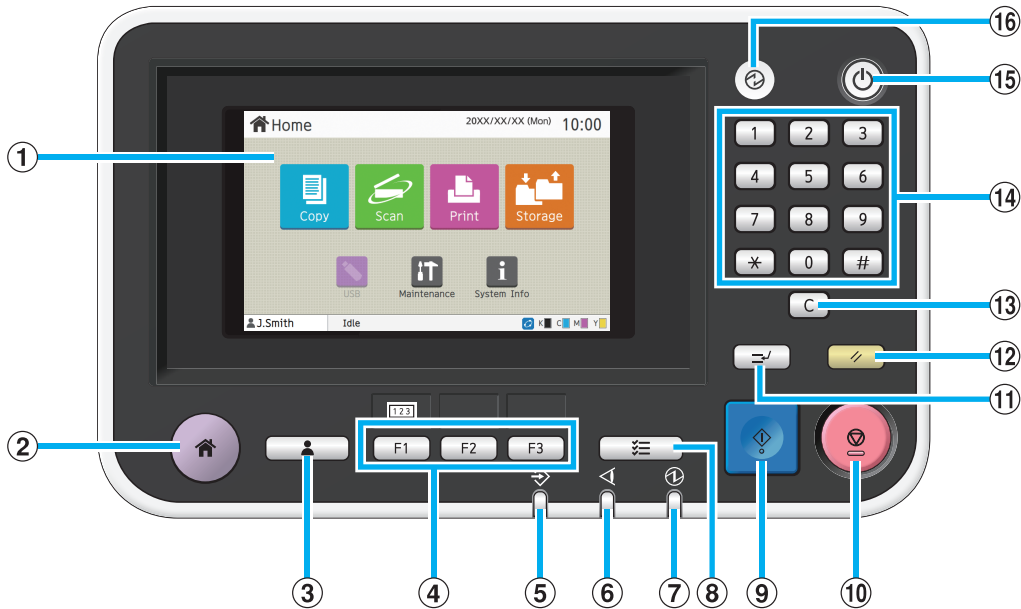

① Touch Panel

Use to perform operations or settings. This panel also displays information such as error messages and confirmation messages. (p. 15 "Touch Panel")

② Home Key

Press this key to bring up the [Home] screen.

③ Login / Logout Key

Press this key to log in or log out.

④ Function Keys

You can preset frequently used functions and settings. Use these keys as shortcut keys.



• For specific instructions on how to register functions and settings, contact your administrator.

⑤ Data Lamp

This lamp lights up when there is a job waiting and flashes when this machine is receiving data.

⑥ Error Lamp

This lamp flashes when an error occurs.

⑦ Main Power Lamp

This lamp lights up when the main power is on.

⑧ Status Key

Press this key to check jobs that are in progress or finished.

⑨ Start Key

Press this key to start an operation.

⑩ Stop Key

Press this key to stop the job that is in progress.

⑪ Interrupt Key

Press this key to pause the job that is in progress in order to execute a different job.

⑫ Reset Key

Press this key to return the settings to their default values.



• Only the settings for the selected mode are reset. The settings for other modes remain unchanged by this operation.

⑬ Clear Key

Press this key to clear letters or numbers that have been entered.

⑭ Numeric Keys

Use these keys to enter numbers.

⑮ Power Key

When you press this key while the main power is on, the operation power turns on and this key lights up. Holding it turns off the operation power, and the machine goes into stand-by mode.

⑯ Wake Up Key

This key lights up when this machine is in power saving mode. Pressing this key when it is lit makes the machine ready for operation.



• Pressing this key when it is not lit makes the machine go into sleep mode.

Touch Panel

[Home] Screen

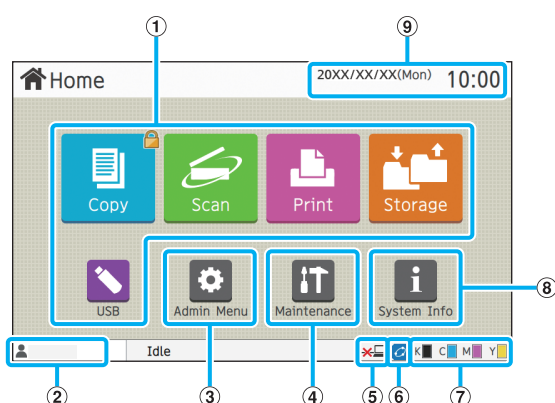

The [Home] screen appears when you press the [Home] key in the operation panel.

To access the settings and operations, touch the button for the mode that you want to use.



- The screen displayed varies depending on your model, the optional equipment connected, and settings.

① Mode Buttons

Touch these buttons to bring up the corresponding mode screen.

A lock icon in the upper right corner of a button indicates that you must log in to access that mode.

② User Name

The name of the user currently logged in is displayed.

③ [Admin Menu] Button

Touch this button to access the administrator settings.



- This button does not appear when the user is not logged in as an administrator.

④ [Maintenance] Button

Touch this button to access maintenance features.

⑤ Offline

This icon is displayed when the machine is not connected to the network.

⑥ FORCEJET™ Link Icon

This icon indicates whether all parts required for printing are working correctly.

For more information, see the separately provided "Troubleshooting Guide".

⑦ Remaining Amount of Ink

These icons indicate the amount of remaining ink for each color. The indicator starts flashing when the time to replace an ink cartridge comes close. Prepare a new ink cartridge for the color that flashes.



- The amount of remaining ink cannot be displayed when using non-RISO ink.

⑧ [System Info] Button

Touch this button to display consumables, machine, and user information.

⑨ Date

The current date and time is displayed.

Mode Screens

Pressing a mode button on the [Home] screen will bring up the corresponding mode screen.

[Copy] Screen

If you are using an optional scanner, you can operate or check copy jobs on this screen.

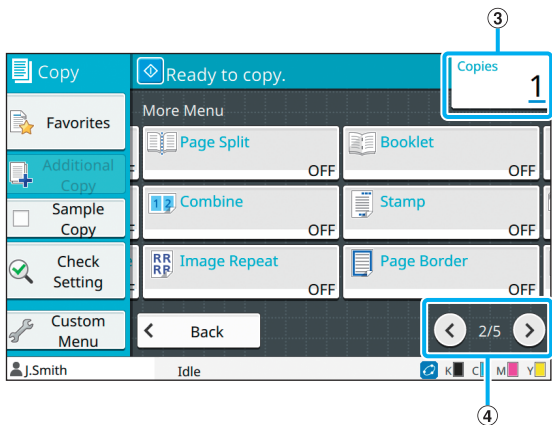
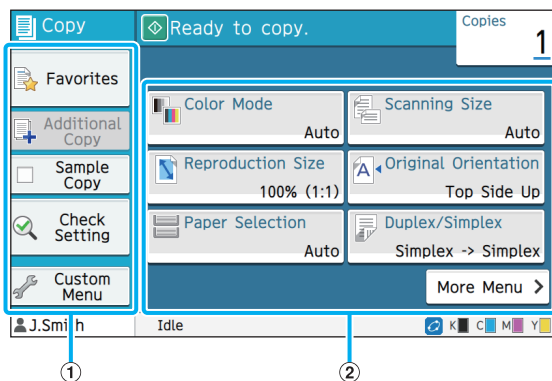

① Function Buttons

Select a function that can be used in Copy mode.

② Setting Buttons

Use these buttons to set up copy functions.

Touch [More Menu] to display other setting buttons.

③ Copies

Enter or check the number of copies here.

④ </> Buttons

Use these buttons to switch the setting button pages.

The current page and total number of setting button pages are displayed.

[Scan] Screen

If you are using an optional scanner, you can operate or check scan jobs on this screen. There are three ways to transmit scan data.

■ Mail

You can send the scanned data by e-mail.

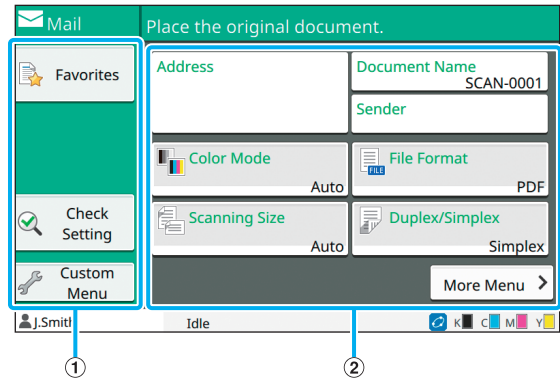

① Function Buttons

Select a function that can be used in Scan mode.

② Setting Buttons

Use these buttons to enter [Address], [Document Name], and [Sender] as well as to set up scanner functions.

Touch [More Menu] to display other setting buttons.

■ PC

You can send the scanned data to a computer on the network.

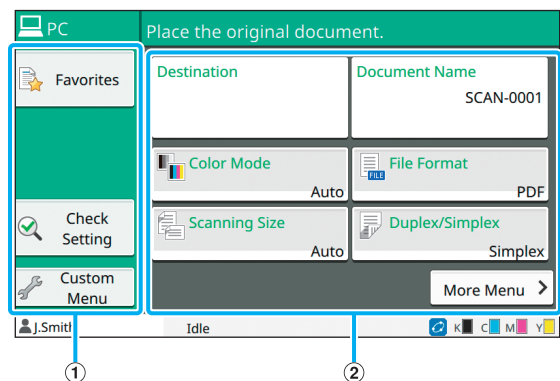

① Function Buttons

Select a function that can be used in Scan mode.

② Setting Buttons

Use these buttons to enter [Destination] and [Document Name] as well as to set up scanner functions.

Touch [More Menu] to display other setting buttons.

■ Console

You can save the scanned data to the internal hard disk of this machine. The saved data can be downloaded from the RISO console.

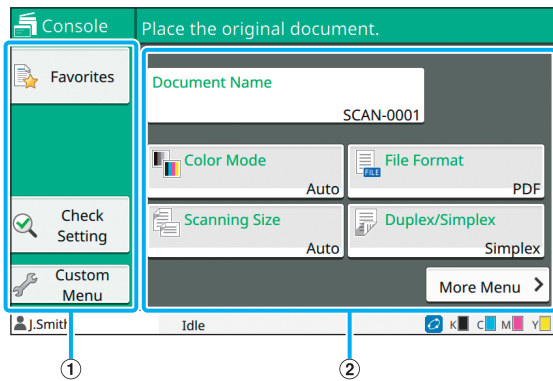

① Function Buttons

Select a function that can be used in Scan mode.

② Setting Buttons

Use these buttons to enter [Document Name] as well as to set up scanner functions.

Touch [More Menu] to display other setting buttons.

[Print] Screen

On this screen, you can operate and check print jobs that are sent from a computer.

■ Waiting Job List Screen

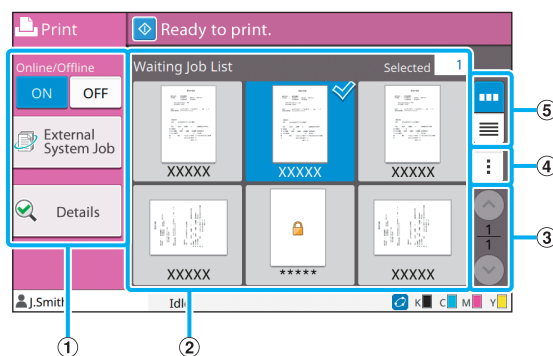

① Function Buttons

Select a function that can be used in Print mode.

② View

Waiting jobs are listed in this view.

③ ^/▽ Buttons

Use these buttons to switch the view pages.

The current page and total number of pages are displayed.

④ Sub Menu

You can edit or delete the settings for the selected job.

⑤ View Selection Buttons

You can select whether to view the waiting jobs as thumbnails or as a list.

: View as thumbnails

: View as list

■ Change Setting Screen

This screen appears when you select [Change Setting] in the sub menu on the [Waiting Job List] screen.

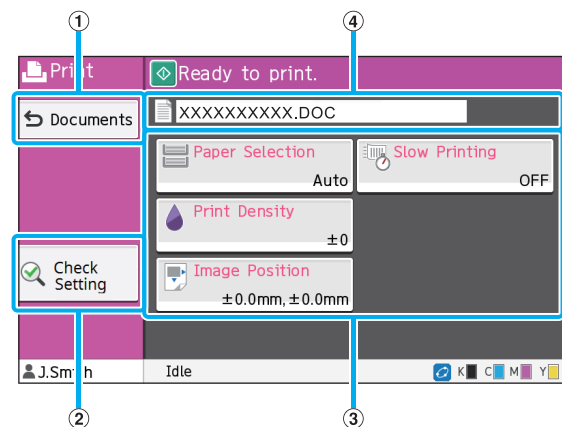

① [Document List] Button

Touch this button to display the [Waiting Job List] screen.

② [Check Setting] Button

Touch this button to display the current settings.

③ Setting Buttons

Use these buttons to set up print functions.

④ Document Name

The name of the selected document is displayed here.

[Storage] Screen

You can operate and check stored jobs on this screen.

The Storage mode has two functions: [Save], which allows you to save data to a folder, and [Load], which enables printing of documents saved in a folder.

Folder List Screen in [Storage] - [Save]

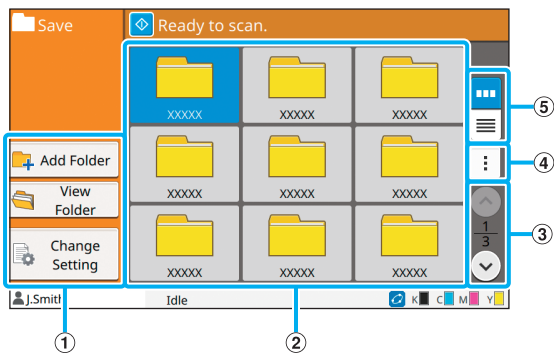

① Function Buttons

Select a function that can be used in Storage mode.

② View

Folders are displayed in a list in this view.

③ ^/▽ Buttons

Use these buttons to switch the view pages.

The current page and total number of pages are displayed.

④ Sub Menu

You can change the color and name of a folder.

⑤ View Selection Buttons

You can select whether to view folders as icons or as a list.

: View as icons

: View as list

Document List Screen in [Storage] - [Save]

This screen appears when you touch [View Folder] on the folder list screen.

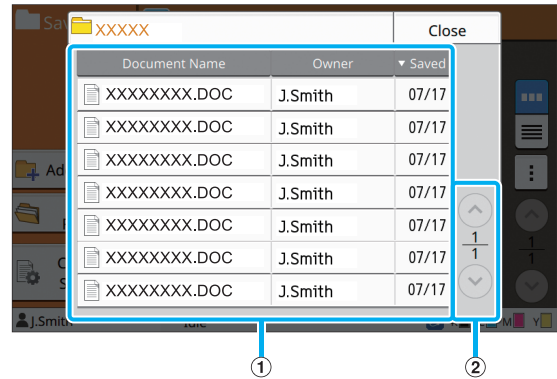

① View

The documents saved in a folder are displayed in a list. [Document Name], [Owner], and [Saved] are displayed.

② ^/▽ Buttons

Use these buttons to switch the view pages.

The current page and total number of pages are displayed.

Change Setting Screen in [Storage] - [Save]

This screen appears when you touch [Change Setting] on the folder list screen.

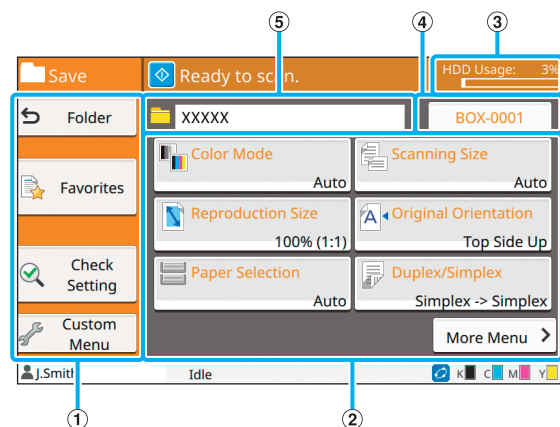

① Function Buttons

Select a function that can be used in Storage mode.

② Setting Buttons

Use these buttons to set up storage (save) functions.

③ [HDD Usage] Indicator

The internal hard disk space currently used is indicated as a percentage.

④ Document Name Button

Press this button to open the [Document Name Setting] screen. Use this button to name a document.

⑤ Destination Folder

The name of the destination folder selected on the folder list screen is displayed here.



If the available space on the internal hard disk is low, delete unnecessary documents in the folder to increase available space.

■ Folder List Screen in [Storage] - [Load]

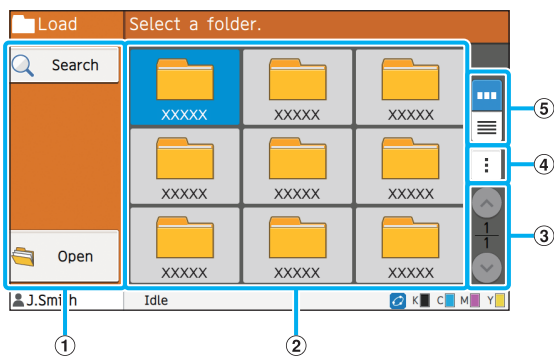

① Function Buttons

Select a function that can be used in Storage mode.

② View

Folders are displayed in a list in this view.

③ ^/▽ Buttons

Use these buttons to switch the view pages.

The current page and total number of pages are displayed.

④ Sub Menu

You can change the color and name of a folder.

⑤ View Selection Buttons

You can select whether to view folders as icons or as a list.

 : View as icons

 : View as list

■ Document List Screen in [Storage] - [Load]

This screen appears when you touch [Open] on the folder list screen.

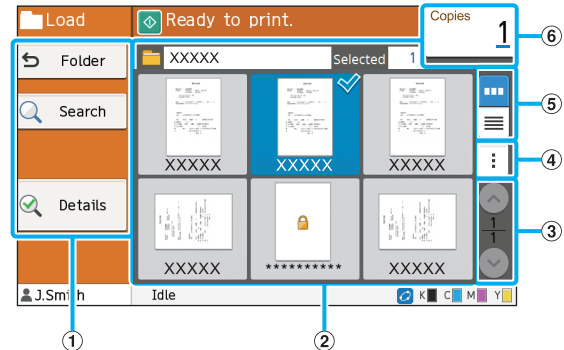

① Function Buttons

Select a function that can be used in Storage mode.

② View

The documents saved in a folder are displayed in a list.

③ ^/▽ Buttons

Use these buttons to switch the view pages.

The current page and total number of pages are displayed.

④ Sub Menu

You can change the name of the selected document, edit the settings for the document, or delete the document.

You can also copy the selected document to a USB flash drive or another folder.

⑤ View Selection Buttons

You can select whether to view the documents as thumbnails or as a list.

 : View as thumbnails

 : View as list

⑥ Copies

Enter or check the number of copies to print.

[USB] Screen

You can operate and check USB jobs on this screen.

The USB mode has two functions: [Save], which allows you to save the scanned data to a USB flash drive, and [Load], which enables printing of documents (prn files) saved to a USB flash drive from the printer driver.

■ Setting Screen in [USB] - [Save]

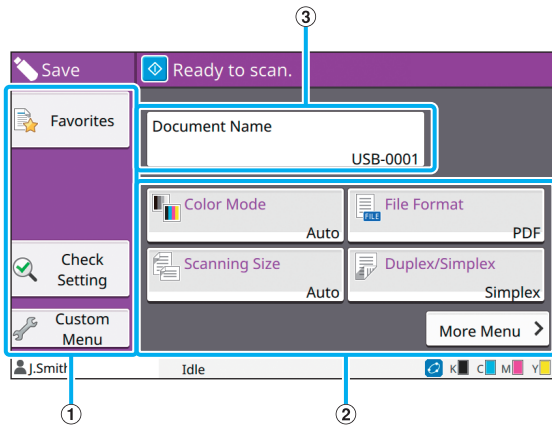

① Function Buttons

Select a function that can be used in USB mode.

② Setting Buttons

Use these buttons to set up USB Save functions. Touch [More Menu] to display other setting buttons.

③ [Document Name] Button

Press this button to open the [Document Name Setting] screen. Use this button to name a document.

■ Document List Screen in [USB] - [Load]

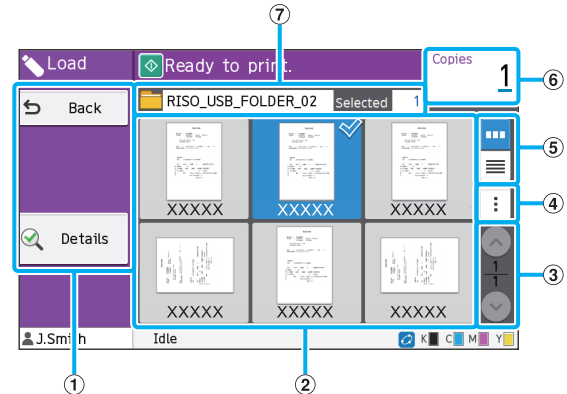

① Function Buttons

Select a function that can be used in USB mode.

② View

The folders and documents saved on a USB flash drive are displayed in a list.

③ (▲)/(▼) Buttons

Use these buttons to switch the view pages.

The current page and total number of pages are displayed.

④ Sub Menu

You can change the print settings for the selected document or copy the document to a folder on the internal hard disk.

⑤ View Selection Buttons

You can select whether to view the folders and documents as thumbnails or as a list.

 : View as thumbnails

 : View as list

⑥ Copies

Enter or check the number of copies to print.

⑦ Folder Name

The name of the selected folder or the folder where the document is saved is displayed here.

Change Setting Screen in [USB] - [Load]

This screen appears when you touch [Change Setting] in the sub menu on the document list screen.

- When you select a PDF file, this screen appears when you touch [Print Setting].

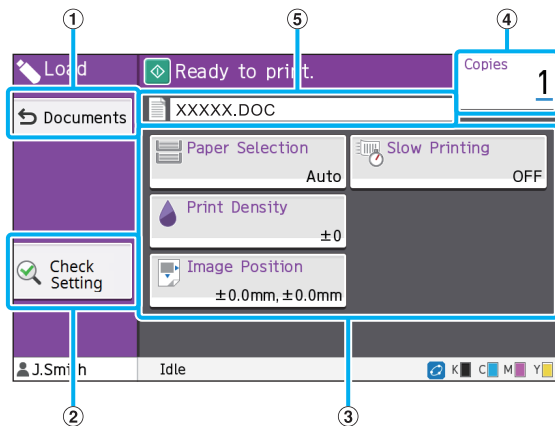

- ① [Documents] Button
Touch this button to display the document list screen.
- ② [Check Setting] Button
Touch this button to display the [Check Setting] screen.
- ③ Setting Buttons
Use these buttons to set up USB Load functions.
When you select a PDF file, touching the [More Menu] button will bring up other setting buttons.
- ④ Copies
Enter or check the number of copies to print.
- ⑤ Document Name
The name of the selected document is displayed here.

[Admin Menu] Screen

This screen is only displayed when you are logged in as an administrator. You can access the settings that an administrator can use and modify. For more information, see the separately provided "Administrator's Guide".

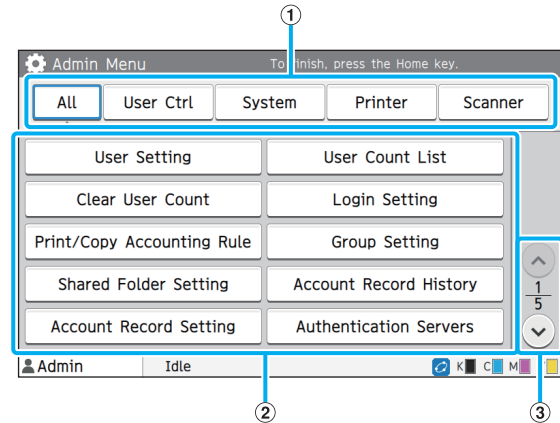

- ① Category Selection Buttons
The categories of administrator menu setting buttons are displayed here.
Touch [All] to show all setting buttons in the administrator menu.
- ② Setting Buttons
Use these buttons to set up the administrator menu functions.
- ③ ^/▽ Buttons
Use these buttons to switch pages.

[Maintenance] Screen

The [Head Cleaning], [Front Cover Release], and other functions are available on this screen. For more information, see the separately provided "Troubleshooting Guide".

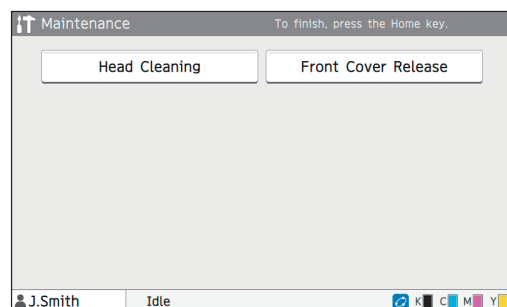

[System Info] Screen

■ Consumables Screen

This screen displays the status of consumables, such as paper and ink. You can also change the tray settings.

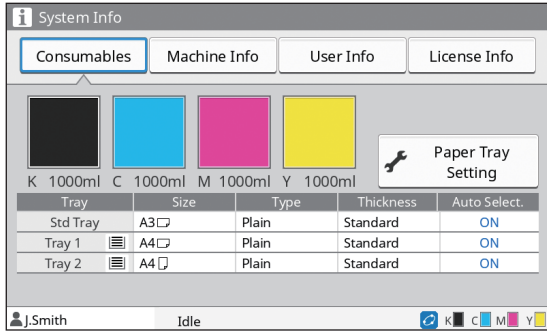

■ Machine Info Screen

This screen displays information about this machine.

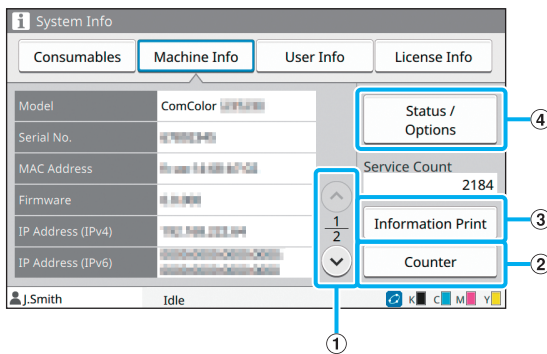

① (^) / (v) Buttons

Use these buttons to switch pages.

② [Counter] Button

Touch this button to view the detailed count for each paper size as well as a meter reading report.

③ [Information Print] Button

Touch this button to print the system information or a sample image.

④ [Connected Devices and Status] Button

Touch this button to display information on the connected optional equipment and its status.

■ User Info Screen

This screen displays the user names and groups of the users logged in.

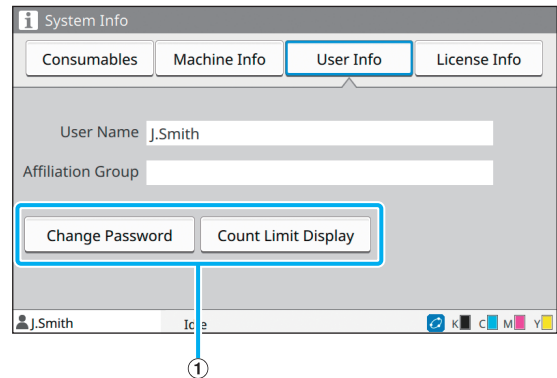

① Information Buttons

Use these buttons to change the account settings of a user or display their usage status.

Touch [Change Password] to change the password.

If a copy or print limit is set by an administrator, touch [Count Limit Display] to view the usage status.

If you are using an optional IC card reader, touch [IC Card] to register the card information for users logged in.



• If you are using an external system link, the following buttons are also displayed.

- [Billing Account]: You can set up an account for billing when using an external system link.
- [View Balance]: You can check the balance of each user who is logged in.

For more information on the billing system using the [External System Link] function, contact your dealer or authorized service representative.

■ License Info Screen

This screen displays the license information of the system used with this product.

Touch Panel

You can operate the machine by using the touch panel and keys on the operation panel. To use a button on the touch panel, touch it with your finger.

Selecting a Button

To select a button on the touch panel, touch the button with your finger.

The selected button will turn blue.

Selected button Buttons not selected

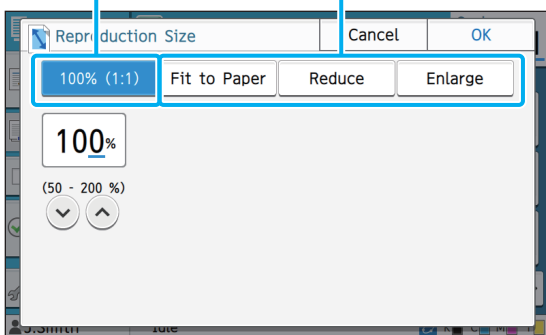

Buttons that are not available under the current conditions are grayed out. You can use these buttons when the required conditions are met. Contact your administrator for details.

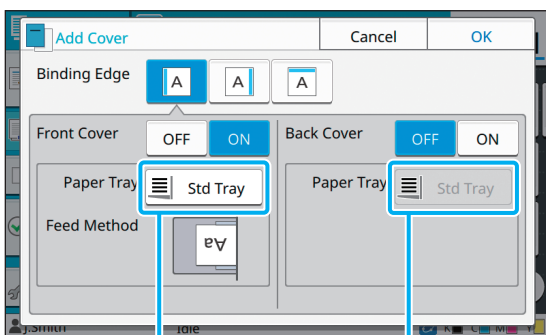

This option is available because [Front Cover] is set to [ON].

This option is not available because [Back Cover] is set to [OFF].

Confirming / Canceling a Setting

When [OK] is displayed on a screen, you must touch [OK] to save the settings. If you do not touch [OK], the settings may be canceled.

To cancel the settings you have edited, touch [Cancel].

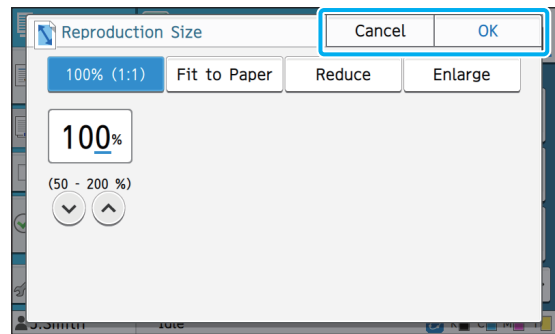

Colors of Setting Buttons

When a setting is changed, the setting button turns color to indicate that the setting has been changed from the default value.



Entering Text

When entering user names or passwords, enter the required information on the text input screen.

1 Touch the characters you want to enter one by one.

To move the cursor, touch [←] or [→]. Touch [✕] if you need to erase a character to the left of the cursor.

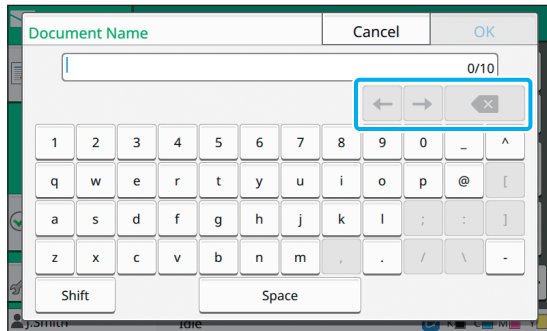

- If the available characters are restricted, as is the case with passwords, the characters that cannot be used are grayed out.
- To enter the upper case letter, touch [Shift] first, and enter the character. To return to the lower case letter input, touch [Shift] again.
- The maximum number of characters that can be entered and the current number of characters entered are displayed to the right of the text input field.

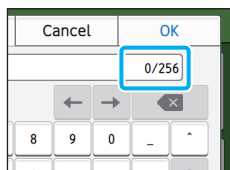

2 After entering the text, touch [OK].

- Depending on the entry area, touching the area may not open up an entry screen. In such cases, enter text using the numeric keys.
- The current selected area is indicated by a flashing short line under numbers or letters. To switch the area, touch the area that you want to enter text in.

Preparation

This chapter explains how to turn on the power, log in, load paper, and other preparatory work to make this machine ready for use.



- When using the feed tray, you do not need to set the standard tray.
- With the RISO console, you can check the status of the machine on your computer. (p. 6-1 "RISO Console")

Power

The machine has two power switches: the main power switch and the [Power] key. Use the main power switch to turn on the main power to the whole printer.

Press the [Power] key to start this machine.



- To turn off the power to this machine in normal use, press and hold the [Power] key on the operation panel.
- Do not turn off the main power unless there is a risk of lightning strike or the machine is not going to be used for an extended period of time.

Turning On the Power

1 Make sure that the power plug is inserted into an electrical outlet.

2 Turn on the main power switch.

The [Main Power] lamp on the operation panel turns on.

3 Press the [Power] key on the operation panel.

The power turns on and the [Power] key lights up.

Turning Off the Power

1 Press and hold the [Power] key on the operation panel.

2 Check that the [Power] key is off, then turn off the main power switch.

The [Main Power] lamp turns off.



- To turn on the main power again, first make sure that the [Main Power] lamp is off.
- Remove the power plug only after turning off the main power switch.

Power-saving Features

If you leave the machine unattended for some time, it automatically goes to power saving mode according to the administrator settings.

The power saving mode has two states: the backlight off state and sleep state. The respective transition times and power consumption in sleep are set by the administrator.

When the power saving mode turns on, the touch panel turns off, and the [Wake Up] key turns on. When you press the [Wake Up] key, the power saving mode is canceled, and the machine returns to normal operating mode.

The machine takes longer to recover from sleep state than from backlight off state.

Login

Lock icons in the upper right corner of mode buttons indicate that you must log in to access those modes.

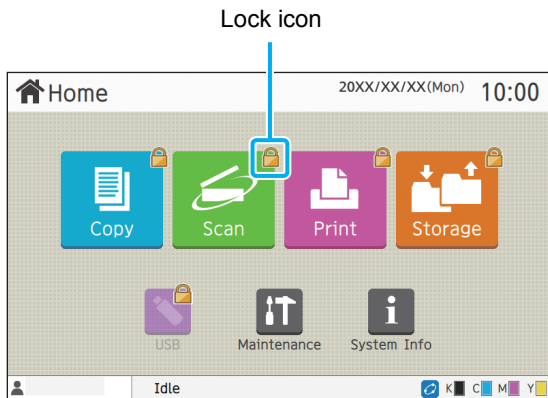

- When logging in for the first time, you need the temporary password that is issued by the administrator.

Logging In

- When using an optional IC card reader, you can log in by holding the IC card over the card reader.

1 Press the [Login/Logout] key.

2 On the [Login] screen, select your name.

To find your name, press [\uparrow] or [\downarrow] to scroll through names, or press the [Index] button to display user names.

The [Password Input] screen appears after you select your name.

3 Input your password and touch [Login].

Follow the displayed instructions for operation.

- When logging in for the first time, change the temporary password to your own password.

When you are successfully logged in, the [Home] screen appears again. Your user name is displayed at the bottom left of the screen.

- After finishing operations, be sure to press the [Login/Logout] key to log out.

- Contact your administrator if you cannot find your name, or if you have forgotten the password.
- If your user name does not appear at the bottom left of the [Home] screen, touch the mode button and perform the operations described in steps 2 and 3 under "Logging In". When you are successfully logged in, the screen for the selected mode appears.

Changing the Login Password

- 1 Touch [System Info] on the [Home] screen after logging in.
- 2 Touch [User Info] - [Change Password].
- 3 Enter the new password and touch [Next].
- 4 On the [Change Password (confirm)] screen, enter the new password again and touch [OK].

Loading Paper

Load paper in the feed trays and the standard tray.

- We recommend loading the feed trays with types of paper you will use most often.
 - Use the standard tray for the following types of paper.
 - Thick paper and other special paper
 - Preprinted paper
 - Postcards
 - Envelopes
- For more information, see "Printing Paper" in the "Safety Information".

Loading Paper in the Feed Trays

1 Pull a tray out, toward the front.

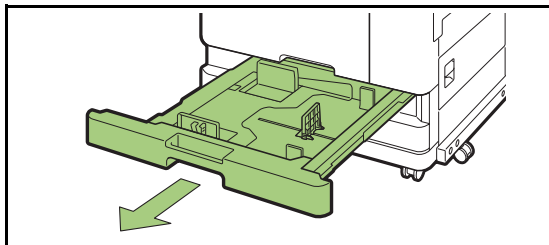

2 Hold the lever of the paper feed guide, and pull it forward to spread the paper feed guide until it stops.

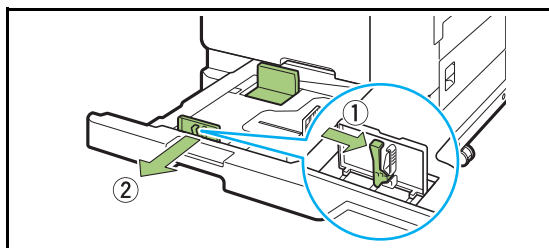

3 Move the stopper to make space.

Move the stopper by holding both sides.

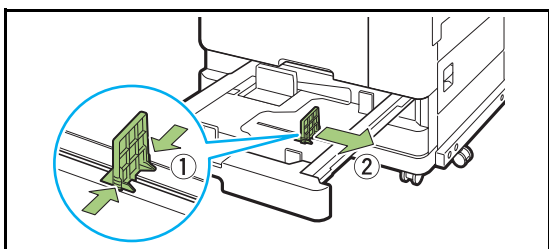

4 Load the paper.

When using paper with different characteristics on the front and back sides, load the printing side face down. Do not load too many sheets.

When loading the paper, be careful not to let its edge contact the paper guides to prevent it from being bent.

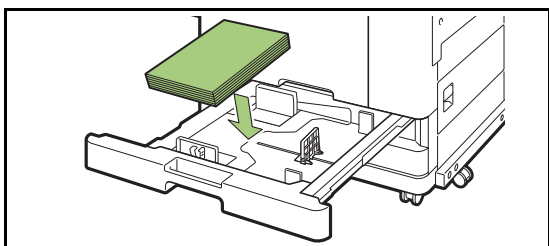

5 Move the paper feed guide and stopper against the edge of the paper.

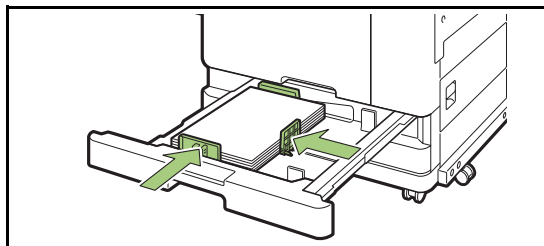

- The machine detects the size of the paper based on the stopper position. Be sure to move the guide and stopper against the edge of the paper.

- To set A3 paper or B4 paper, install the A3/B4 paper guide properly for each type. Pinch both sides of the A3/B4 paper guide, slide it out and then slide it into the appropriate hole for the desired paper size.

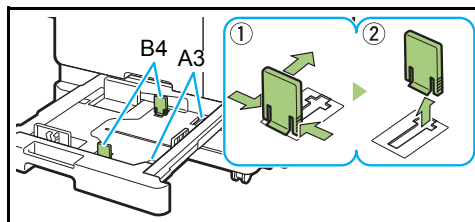

When using B4 paper

6 Push the tray back into the machine.

7 On the operation panel, check the tray settings.

When you have switched to a different type or size of paper, update the feed tray settings. (p. 1-7 "Paper Selection")

Loading Paper in the Standard Tray

1 Open the standard tray until it stops.

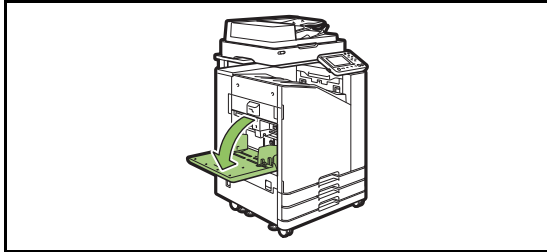

2 Spread the guides.

Raise the paper feed guide levers (both sides) to unlock and slide the guides.

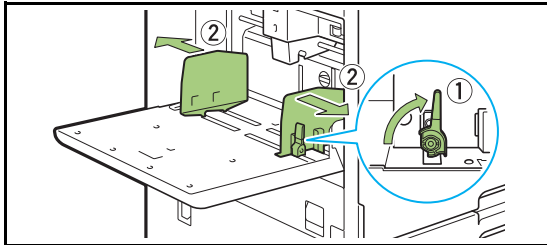

3 Load the paper.

Load paper with the printing side face up.

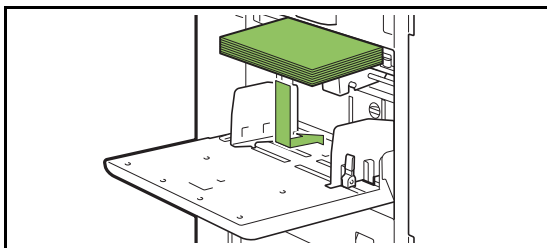

- When printing on envelopes, it is recommended that you connect the optional stacking tray and envelope feeder.
- Be sure to load envelopes with their flaps open and their bottom side entering the machine first.

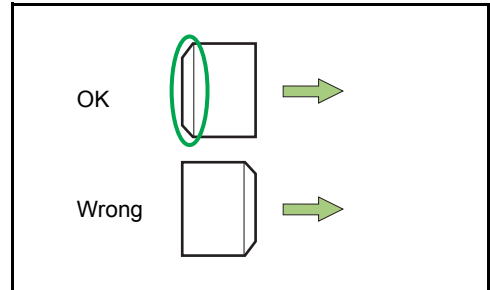

- The [Rotation] feature is useful for printing on envelopes from a computer.

4 Adjust the paper guides so that they are suitable for the paper size.

Move the guides against the edges of the paper, and push the lever to lock.

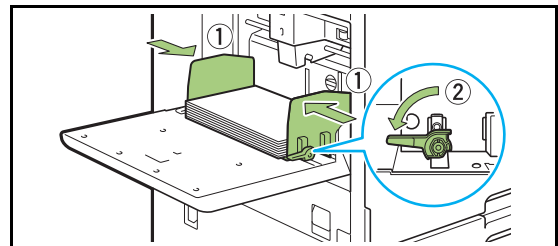

- The machine detects the paper size at the guide position. Be sure to move the guides against the edge of the paper.

5 Adjust the paper feed pressure adjustment lever.

For general use, set to "✕(NORMAL)". For envelopes, drawing paper, postcards, and similar products, set to "✎(CARD)".

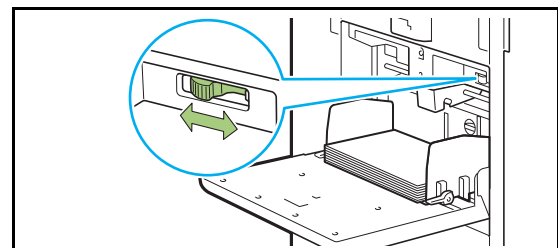

6 On the operation panel, check the tray settings.

When you have switched to a different type or size of paper, update the feed tray settings. (p. 1-7 "Paper Selection")

Adding or Switching Paper in the Standard Tray

Press the standard tray descent button when loading additional sheets or when switching paper. Note that the standard tray is automatically lowered when all paper is removed.

1 Press the standard tray descent button to lower the standard tray.

Hold the button down until the tray reaches the desired position.

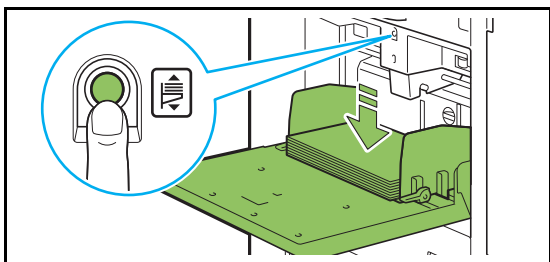

2 Load additional paper, or switch the loaded paper.

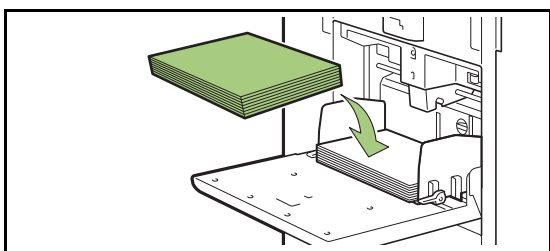

Closing the Standard Tray

- ! Make sure that the power is on when you perform this operation.

1 Remove the loaded paper.

The standard tray starts lowering.

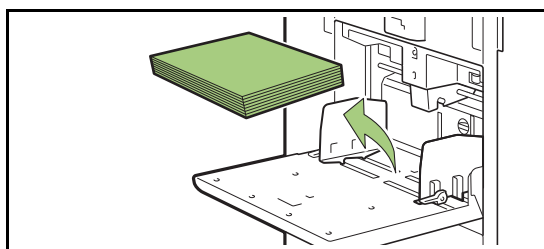

2 Close the standard tray.

- ! Make sure the standard tray is all the way down before closing it.

Installing the Printer Driver

If you want to send data from a computer to print on this machine, you must first install the printer driver onto the computer.



- Log in as a user with administrator privilege.
- Close all active applications.
- For specific instructions on how to uninstall the printer driver, see the separately provided "Administrator's Guide".

Operating Environment

The system requirements for activating the printer driver are described in the table below.

Memory	1 GB or more
CPU	Intel or fully compatible CPU
Hard disk	2 GB or more free space (Space enough to operate the OS)
Display	1024 × 768 or greater resolution

Installing

1 Load the included DVD-ROM in the computer's DVD-ROM drive.

The installation wizard automatically starts up. If the installation wizard does not start up, double-click the file "Install.exe" on the DVD-ROM.

2 Select the desired language in the pull-down menu and click [OK].

3 Click [Next].

4 Follow the on-screen instructions to configure the settings.

5 When the message for printing a test page is displayed, click [Yes].

6 Confirm that the test page is printed correctly and click [OK].



- Pressing [Show ReadMe] will bring up the ReadMe. The ReadMe includes precautions for using the machine. Be sure to read it.

7 Click [Finish].

When the printer driver is installed over the existing one, the computer restarts.



- If you do not want to restart the computer now, remove the check mark from the [Restart now] check box before clicking [Finish].

8 Remove the DVD-ROM from the computer.



- Keep the DVD-ROM in a safe place for future reference.

About Jobs

This section describes how to use [Details], [Print], [Delete], and other functions available from the Document List of each screen. Press the [Job Status] key to view jobs.



- A job is the unit of tasks performed by this machine in each mode (e.g. Print mode, Copy mode).
- In the following cases, the job name is displayed as "*****".
 - Jobs with the [Hide Job Name] check box selected on the printer driver (p. 3-24 "PIN Code")
 - Jobs that belong to users other than the user currently logged in when [Job Name Display] is set to [OFF] on the administrator menu

[Active / Idle] Screen

Touching [Active/Idle] displays a list of jobs in progress and jobs waiting to be printed. Jobs are printed in order from the top of the list.

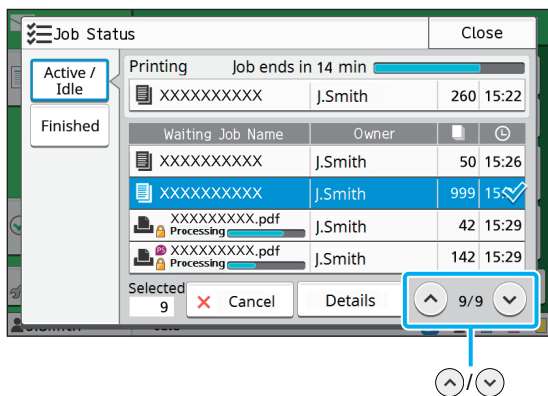

- Output order (order of job priority) under [Active/Idle]
When copying is performed on the machine, the copy job has priority over jobs sent from the printer driver. The selected jobs are processed after the copy job is finished.

Job List

The job list displays the job name, status, owner name, number of copies, and receiving time for jobs that are being printed, in processing, and waiting to be printed.

An icon indicating the job type is displayed on the left side of the job name.

Icon	Job Type
	Copy job
	Print job
	Storage (Load) job
	USB (Load) job
	PS job (when using the optional PostScript kit)
	Job with a PIN code
	Broken job



- Touch / to switch the pages in the list.

Checking the Current Status of a Job

The current status of the job being printed and processed is displayed with a progress bar. The expected finish time is also displayed for the jobs currently printed.



- If the Mixed Size Original function is used or when the number of pages of the print job is unknown, the expected finish time will not be displayed.

Canceling a Job

To cancel a job, select the job that you want to cancel and either touch [Cancel] or press the [Stop] key. To cancel a job with a PIN code, you need to enter the PIN code.

Checking the Details of a Job

Touch [Details] to view the details of a job in progress or waiting to be printed.

[Finished] Screen

Touch [Finished] to display a list of completed jobs.

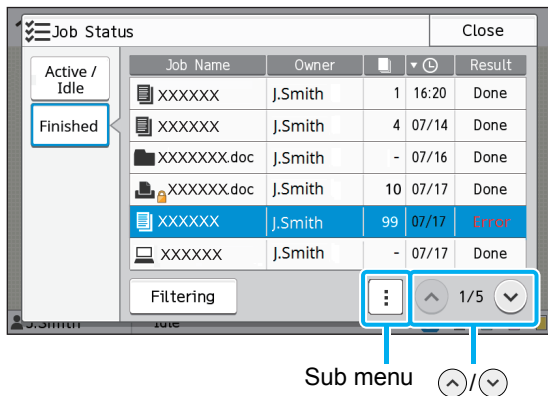

You can check the job name, owner, number of printed copies, print date/time, and processing result.

An icon indicating the job type is displayed on the left side of the job name.

Icon	Job Type
	Copy job
	Print job
	Scan (Mail) job
	Scan (PC) job
	Scan (Console) job
	Storage (Save/Load) job
	USB (Save/Load) job
	PS job (When using the optional PostScript kit)
	Job with a PIN code
	Broken job



- Touch the sub menu to check the details of a job, print the job again, or delete the job. If you are using an external system link, you can check the billing amount.

- Touch [Filtering] to set the types of completed jobs to be listed.

- Touch ^ / v to switch the pages in the list.

- Touch categories such as [Job Name] or [Owner] to switch the sorting order between ascending and descending for display.

- This list also displays a history of processed jobs. The save period and number of jobs displayed in the list are specified by the administrator. Contact your administrator for details.

Paper documents are scanned and copied using a scanner.

Different copying options are available to suit your purpose and applications, for example, duplex copying and copying multiple paper documents to one sheet.

Overview of Copy Operationsp. 1-2

1. Load the original.



2. Touch [Copy] on the [Home] screen.



3. Change the settings.



4. Specify the number of copies using the numeric keys.



5. Press the [Start] key.

Copy Settings.....p. 1-7

This section explains each copy setting in detail.

Copy Mode Function Buttons.....p. 1-24

This section explains the functions available in Copy mode.



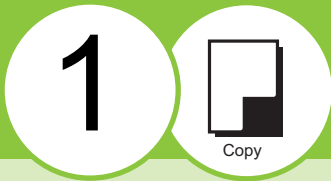

Copy

Overview of Copy Operations

This section explains the basic copy operations.

Procedure

1 Load the original.

For more information on the types of originals that can be loaded, see "Originals" in the "Safety Information".

■ In the ADF

1 Load the original in the ADF.

Align the originals and place them face up.

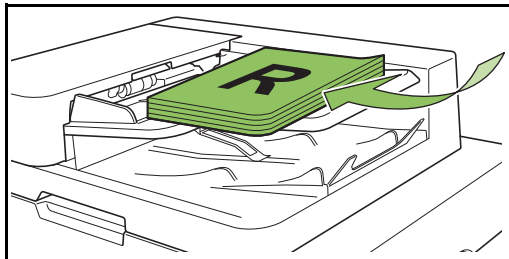

2 Slide the original guides to match the width of the originals.

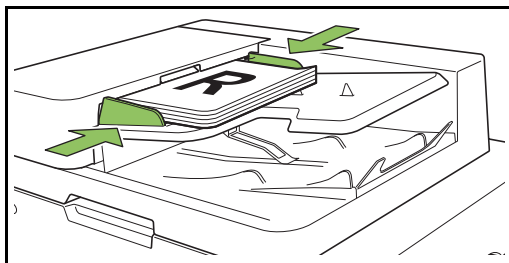

■ On the Platen Glass

1 Open the original cover.

2 Loading Originals.

Load the original face down on the glass. Align the corner of the original with the upper-left corner of the glass.

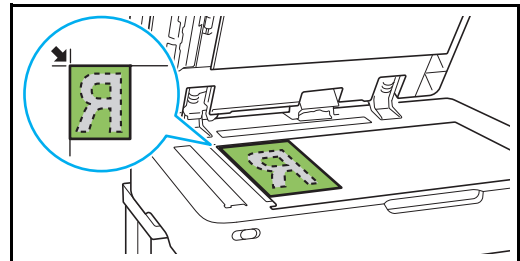

3 Close the original cover.

! • Open and close the original cover gently.

2 Touch [Copy] on the [Home] screen.

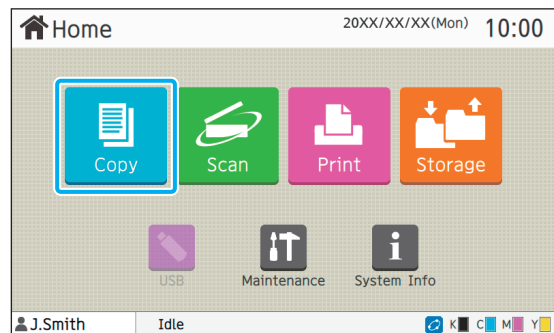

3 Change the settings.

Specify the copy finishing settings. For more information on the functions that can be configured, see "List of Settings" (p. 1-5).

4 Specify the number of copies using the numeric keys.

Enter the desired number of copies, up to a maximum of 9,999.

5 Press the [Start] key.

The [Copying] screen is displayed, and copying of the original starts. The current status is displayed on the screen.

- When you select [Slow Printing], the printing speed will slow down and the operating sound for the job in progress will be quieter.
- If another job is being printed, a message is displayed and the copying starts after finishing the ongoing job.



- When you need to copy a document while a job is being printed, press the [Interrupt] key to pause the current job, and start another copy job.

When using the platen glass to scan an original with several pages

After scanning one page of an original, a screen with a message asking whether there is another page to be scanned appears.

When there is another page to be scanned, load the next page and touch [Scan]. After all pages of the original are scanned, touch [Scanned].

Loading the Next Copy Job

During copying, once scanning of the original has been completed, you can begin scanning the next original.

1 Press [Close] on the [Copying] screen.

2 Load the next original and press the [Start] key.

A message appears, and the original is copied as the next job.

Canceling Copying

1 Press the [Stop] key.

The [Suspending] screen is displayed.

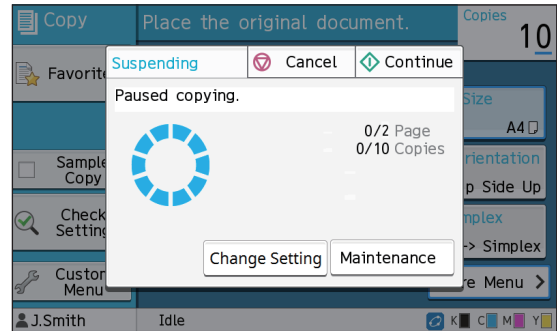

2 Touch [Cancel].

The [Confirm] screen is displayed.

3 Touch [OK].

Copying is canceled.

4 Touch [Close].

Changing the Settings During Copying

1 Press the [Stop] key.

The [Suspending] screen is displayed.

2 Touch [Change Setting].

The [Change Setting] screen is displayed.

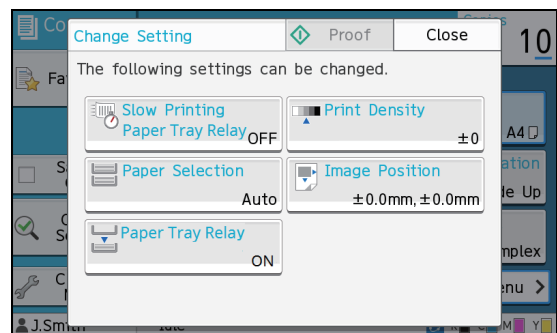

3 Change the settings.

You can change the following settings.

- Slow Printing (p. 1-22 "Slow Printing")
- Print Density (p. 1-10 "Print Density")
- Paper Selection (p. 1-7 "Paper Selection")
- Image Position (p. 1-18 "Image Position")
- Paper Tray Relay (p. 1-22 "Paper Tray Relay")



• If you touch [Proof], only one copy of the page that was being processed when the [Stop] key is pressed is output.

4 Touch [Close].

5 Touch [Continue].

Copying of the job with changed settings starts.

Performing Maintenance During Copying

1 Press the [Stop] key.

The [Suspending] screen is displayed.

2 Touch [Maintenance].

The [Maintenance] screen is displayed.

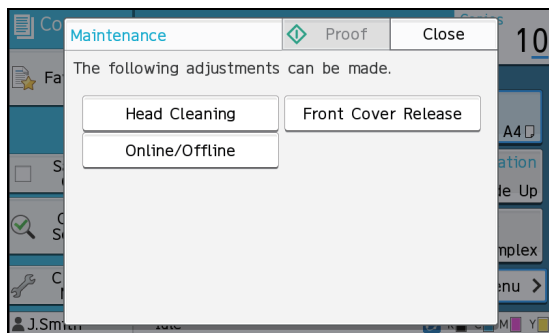

3 Make the necessary adjustments.

The following maintenance options are available.

- Head Cleaning
- Paper Guide Control
- Online/Offline
- Front Cover Release



• Touch [Online/Offline] to display the [Online/Offline] screen. You can monopolize the printer by disconnecting from the network.

• For more information on [Head Cleaning] and [Front Cover Release], see the separately provided "Troubleshooting Guide".

• If you touch [Proof], only one copy of the page that was being processed when the [Stop] key is pressed is output.

• If you are using the optional auto-control stacking tray, you can adjust the position of the stacking tray from [Paper Guide Control].

For more information, see the separately provided "Troubleshooting Guide".

4 Touch [Close].

5 Touch [Continue].

The copy job is resumed with the adjustment applied.

List of Settings

The following is a list of settings available in Copy mode.

Setting item	Description	See
Color Mode	Select color or monochrome printing.	p. 1-7
Reproduction Size	Use this to reduce or enlarge the copied image.	p. 1-7
Paper Selection	Change the paper tray, paper type, and feed control settings according to the copying paper.	p. 1-7
Scanning Size	Specify the scanning size for originals.	p. 1-9
Original Orientation	Specify the orientation of the original.	p. 1-9
Duplex / Simplex	Specify the sides of the original to be scanned and the sides of the paper to be printed on.	p. 1-10
Sort	Specify the printing method for making multiple copies of the original.	p. 1-10
Scanning Level	Adjust the scanning level of originals.	p. 1-10
Print Density	Specify the print density.	p. 1-10
ADF Scan & Pause	Use this option to copy as one job even when having to load the original in multiple sets due to the large number of pages in the original.	p. 1-11
Mixed Size Original	Use this option when multiple different original sizes are used in the original.	p. 1-11
Book Shadow Erasure	Use this option to remove shadows that appear in the center of copies when an open book is copied.	p. 1-12
Page Split	Use this option to scan double-spread pages into two parts (right and left).	p. 1-12
Combine	Use this option to impose continuous pages onto one sheet.	p. 1-13
Image Repeat	Use this option to impose multiple copies of the same original onto one sheet.	p. 1-13
Booklet	Specify the imposition when creating a booklet.	p. 1-14
Stamp	Use this option to print the page number and date on the header or footer.	p. 1-14
Page Border	Use this option to add a border line in the margins of the paper.	p. 1-16
Image Quality	Specify the resolution for scanning originals.	p. 1-16
Original Type	Select the original type so that the appropriate image processing is performed before printing the scanned data.	p. 1-16
Gamma Correction	Use this option to adjust the color balance (CMYK) of the scanned data.	p. 1-17
Image Control	Specify the image processing of the original.	p. 1-17
Base Color Level	Make the background color (base color) lighter so that the text is easier to read.	p. 1-18
Image Position	Specify this when adjusting the print position.	p. 1-18
Program	Specify this when the number of required copies varies by group (such as corporate division or classes). You can quickly print exactly the number of copies of the number of sets you need.	p. 1-18
Add Cover	Specify this to add front and back covers to the front and back of the printout.	p. 1-20
Separation	Configure the settings for slip sheets. When the optional face down finisher is connected, the offset output setting is also available.	p. 1-21
Binding Margin	Specify the binding margin.	p. 1-22

Chapter 1 Copy

Setting item	Description	See
Staple	Configure the settings for staples. (When using the optional face down finisher)	p. 8-6
Slow Printing	Use this option to slow down the printing speed. This also reduces the operating sound of a job being processed.	p. 1-22
Output Tray	Select the output tray for printouts. (When using the optional stacking tray)	p. 8-11
Output Tray Relay	Use this option to automatically switch the output tray when the one being used becomes full. (When using the optional auto-control stacking tray)	p. 8-11
Paper Tray Relay	Use this option to automatically feed paper from a different tray with the same paper size and paper type when the selected tray runs out of paper.	p. 1-22
Auto Image Rotation	Use this option to rotate the image 90 degrees automatically when the orientation of the original and paper do not match.	p. 1-22
Interrupt Copy	By using this function, you can pause the job being printed to copy another job.	p. 1-23
Favorites	This function calls frequently used settings.	p. 1-24
Additional Copy	Use this option when copying the original that was just copied, again, without re-scanning.	p. 1-24
Sample Copy	Use this option to check the printing result when making a large number of copies; the machine stops after printing one copy.	p. 1-25
Check Setting	Use this option to check the current settings.	p. 1-25
Custom Menu	Register favorites and default settings, and edit the button order.	p. 1-25

Copy Settings

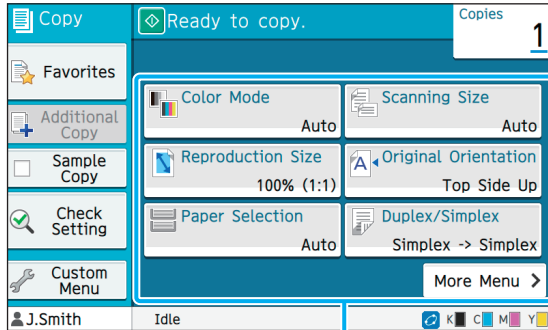

Setting buttons

Color Mode

Select color or monochrome printing.

[Auto]

Select this option if you want the machine to automatically detect the color of the original and copy in color (cyan, magenta, yellow, and black) or black and white.

[Full Color]

Select this option to copy by converting the original data to four-color data (using cyan, magenta, yellow, and black).

[Black]

Select this option to copy in one color (black) regardless of the color of the original.

[Cyan]

Select this option to copy in one color (cyan) regardless of the color of the original.

[Magenta]

Select this option to copy in one color (magenta) regardless of the color of the original.

1 Touch [Color Mode].

The [Color mode] screen is displayed.

2 Select the color mode.

3 Touch [OK].

Reproduction Size

Copy at the specified reproduction size.

[Same Size (100%)]

Select this option to copy at 100%.

[Fit to Paper]

The reproduction size is set automatically based on the original size and paper size. (p. 1-7 "Paper Selection")

[Reduce]

Select this option to copy by reducing a standard size original to fit another standard size paper.

[Enlarge]

Select this option to copy by enlarging a standard size original to fit another standard size paper.

Manual

Specify the reproduction size to enlarge or reduce the original when copying.

1 Touch [Reproduction Size].

The [Reproduction Size] screen is displayed.

2 Specify the reproduction size.

To use a user-defined reproduction size, touch [⏏] or [⏏] to specify the size. You can also enter the number using the numeric keys.

3 Touch [OK].

Paper Selection

Select the paper tray.

You can also change the tray settings (paper size, paper type, double-feed check, and auto selection).

[Auto]

Select this option if you want the paper tray to be automatically selected from the tray selection.

Paper tray selection

When using a paper size that is different from the original size, or to use a tray with [Auto Selection] not set to [ON], select a paper tray.

[Paper Tray Setting]

Change the paper tray settings.

1 Touch [Paper Selection].

The [Paper Selection] screen is displayed.

2 Select [Auto] or select a paper tray.

3 Touch [OK].



• If you use the "Mixed Size Original" (p. 1-11) option, [Paper Selection] will be set to [Auto].

Changing the Paper Tray Setting

Touch [Paper Tray Setting] to change the paper tray settings. When changing the paper loaded in a tray, be sure to change the paper tray settings.

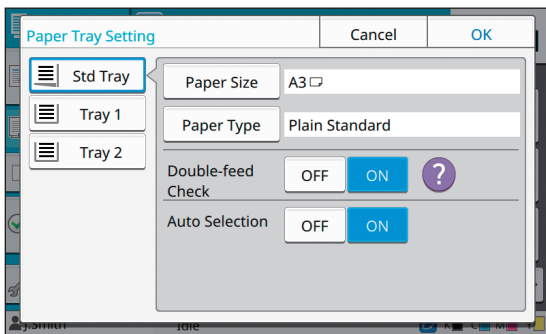

Paper tray selection

Select the paper tray for which you are going to change the settings.

[Paper Size]

Select the paper size.

[Paper Type]

Select the paper type and thickness.

[Double-feed Check]

Select whether to check for the feeding of multiple sheets of paper. Normally, this setting is set to [ON]. This function uses light permeability to detect multiple sheets of paper, so when using paper printed on the back or paper with a dark base color or envelopes, select [OFF].

[Auto Selection]

Set this option to [ON] to make a paper tray available for automatic selection.

1 Touch [Paper Tray Setting] on the [Paper Selection] screen.

The [Paper Tray Setting] screen is displayed.

2 Select the paper tray for which you are going to change the settings.

3 Touch [Paper Size].

The [Paper Size] screen is displayed.

4 Select a paper size and touch [OK].

5 Touch [Paper Type].

The [Paper Type] screen is displayed.

6 Select a paper type and touch [OK].

7 Select the double-feed check setting.

8 Select whether to make this paper tray available for automatic paper tray selection.

9 Touch [OK].



• It is recommended that trays that are loaded with special paper (high-quality paper, color paper, thick paper, paper with letterhead, etc.) should not be set to be available for auto selection.

■ Paper Size

[Auto]

Select this option if you want standard size originals to be detected automatically.

[Standard]

Specify the standard size.

[Custom]

Select this option to select from non-standard paper sizes registered by the administrator in advance.

[Manual]

Specify the non-standard paper size that is not registered.

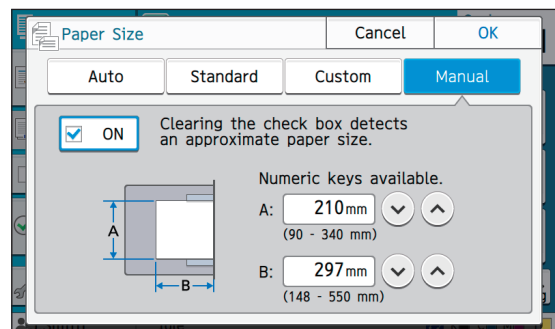



- If the paper size is not specified, the sheet width is set to the width of each paper tray guide. The maximum length of the relevant tray is used for the length.

■ Paper Type

[Type], [Thickness]

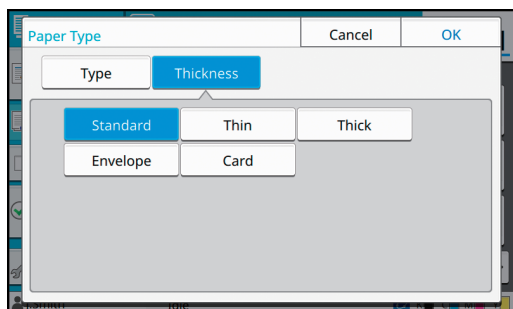
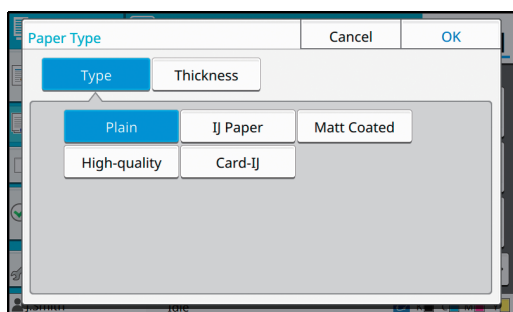

- If the thickness of the paper loaded in the standard tray is set to [Envelope], duplex printing cannot be performed from the standard tray.
- The machine selects the color profile according to the selected paper type. (When you change the paper type, the printing result changes.) If the printing result is not what you expected, change the paper type.
- When using special paper, you can add settings to [U1] through [U5] for [Thickness]. For more information, contact your dealer or authorized service representative.

Scanning Size

Specify the scanning size for originals.

[Auto]

Select this option if you want the scanning size of the original to be automatically detected.

[Standard]

Select this option when using a standard size different from that of the original.

[Custom]

Select this option to select from non-standard paper sizes registered by the administrator in advance.

[Manual]

Specify the non-standard paper size that is not registered.

1 Touch [Scanning Size].

The [Scanning Size] screen is displayed.

2 Specify the scanning size for originals.

To use a non-standard size that is not registered, touch [⏴] or [⏵] on the [Manual] screen to enter values. You can also enter the number using the numeric keys.

3 Touch [OK].

Original Orientation

[Top Side Up]

Select this when loading the original with the top of the original facing toward the back of the platen glass or the ADF.

[Top Side Left]

Select this when loading the original with the top of the original facing toward the left of the platen glass or the ADF (so that the text of the original is sideways).

1 Touch [Original Orientation].

The [Original Orientation] screen is displayed.

2 Select the original orientation.

3 Touch [OK].

Duplex / Simplex

Specify the combination of the sides of the original to be scanned and the sides of the paper to be printed on.

[Simplex -> Simplex]

One side of the original is scanned and printed on a single side of paper.

[Simplex -> Duplex]

One side of the original is scanned. The scanned data is then printed on both sides of paper.

[Duplex -> Duplex]

Both sides of the original are scanned and copied to separate sides of paper.

[Duplex -> Simplex]

Both sides of the original are scanned. The scanned data of the two sides are copied onto a single side of two separate sheets of paper.

[Paging Direction]

Specify whether pages are opened right/left or top/bottom.

[Original Orientation] (p. 1-9 "Original Orientation")

How to set the combination of scanning sides and printing sides is explained below using an example of copying data scanned from a single side of the original to both sides of paper.

1 Touch [Duplex/Simplex].

The [Duplex/Simplex] screen is displayed.

- If the [Confirm] screen appears, set the original orientation to [Top Side Up] or [Top Side Left].

2 Touch [Simplex -> Duplex].

3 Specify the paging direction.

4 Touch [OK].

Sort

Specify the paper output method when making multiple copies.

[Collated]

Select this option to make copies in sets.

[Uncollated]

Select this option to copy by page.

1 Touch [Sort].

The [Sort] screen is displayed.

2 Select the sorting type.

3 Touch [OK].

Scanning Level

You can adjust the scanning level of originals.

[-2], [-1], [±0], [+1], [+2]

1 Touch [Scanning Level].

The [Scanning Level] screen is displayed.

2 Select the scanning level.

3 Touch [OK].



- You can make the background color (base color) lighter so that the text is easier to read when copying text originals with a background color or originals printed on colored paper. (p. 1-18 "Base Color Level")

Print Density

You can adjust the amount of ink to be used for printing.

[-3], [-2], [-1], [±0], [+1], [+2], [+3]

1 Touch [Print Density].

The [Print Density] screen is displayed.

2 Select the print density.

3 Touch [OK].

ADF Scan & Pause

When copying a quantity of originals that cannot be loaded at one time in the ADF, these can be copied as one job. Up to 1,000 one-sided originals or 500 two-sided originals can be copied as one job.



- The maximum number of sheets that can be loaded at one time in the ADF is 200 sheets (with a paperweight of 80 g/m² (21-lb bond)).
- Scan all originals using the ADF, and do not use the platen glass.

[OFF], [ON]

1 Touch [ADF Scan & Pause].

The [ADF Scan & Pause] screen is displayed.

2 Touch [ON].

3 Touch [OK].

4 Press the [Start] key.

The [Copying] screen is displayed, and copying of the original starts. The current status is displayed on the screen.

When there are no sheets of the original in the ADF, the original add confirmation screen is displayed.

5 Load the subsequent pages of the original into the ADF, and touch [Scan].

The scanning of the original starts.

Repeat this step until all pages are scanned.

6 Touch [Scanned].

The printing of the scanned data starts.

Mixed Size Original

Use this option when loading originals of two different sizes in the ADF.

Load the original with the sides of the same length aligned (A4-LEF* and A3, B5-LEF and B4, or Letter-LEF and Ledger).

* Long Edge Feed

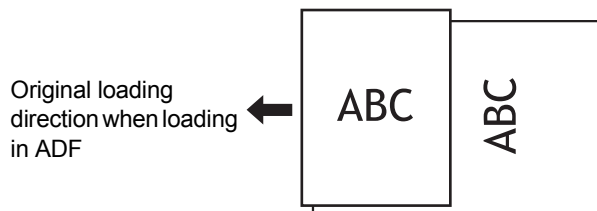

- [Mixed Size Original] cannot be used in combination with the [Booklet], [Book Shadow Erasure], [Combine], [Image Repeat], [Page Split], or [Page Border] option. (p. 1-14 "Booklet", p. 1-12 "Book Shadow Erasure", p. 1-13 "Combine", p. 1-13 "Image Repeat", p. 1-12 "Page Split", p. 1-16 "Page Border")

- You can use any combination of the original size when scanning on the platen glass.
- Use the [Mixed Size Original] option when scanning originals of different sizes on the platen glass and collating the pages.

[OFF], [ON]

1 Set [Paper Selection] to [Auto].

For more information, see "Paper Selection" (p. 1-7).

2 Touch [Mixed Size Original].

The [Mixed Size Original] screen is displayed.

3 Touch [ON].

4 Touch [OK].

Book Shadow Erasure

This function removes the shadows that appear in the center (inner margin) when scanning a book or other bound documents.

- When placing a book on the platen glass, place it top side up and aligned with the arrow at the upper left of the glass surface. This function cannot be used with the book placed vertically or at an angle.

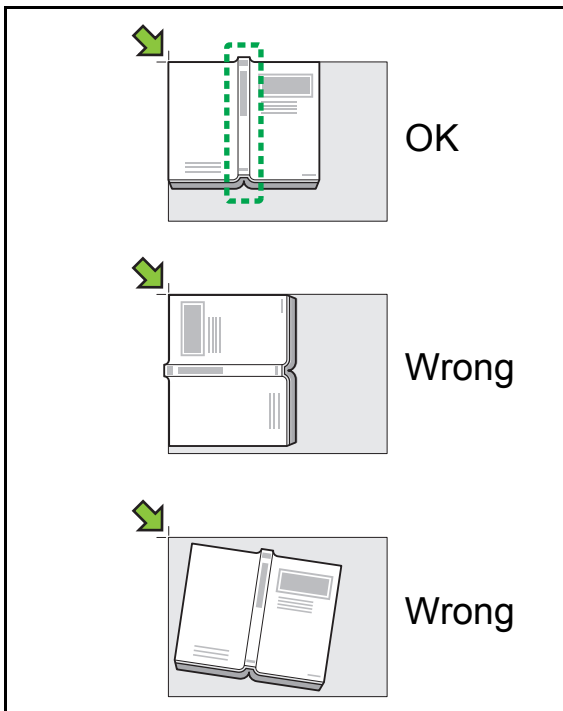

[OFF], [10mm] (3/8"), [20mm] (13/16"), [30mm] (1 3/16"), [40mm] (1 9/16"), [50mm] (1 15/16")
 [Page Split] (p. 1-12 "Page Split")

- 1 Touch [Book Shadow Erasure].**
The [Book Shadow Erasure] screen is displayed.
- 2 Select the erasure width.**
- 3 Set [Page Split].**
For more information, see "Page Split" (p. 1-12).
- 4 Touch [OK].**

Page Split

Use this option to scan double-spread pages into two parts (right and left).

The original sizes that can be page-split are as follows.

A3, A4, A5, B4, B5, Ledger, Letter

- When placing a book on the platen glass, place it top side up and aligned with the arrow at the upper left of the glass surface. This function cannot be used with the book placed vertically or at an angle.

[Page Order]

When this option is set to [OFF], the page split function is not available.

Set the page order to [Left to Right] for books that are opened from the left.

Set the page order to [Right to Left] for books that are opened from the right.

[Page Selection while Scanning]

When this option is set to [OFF], the double-spread pages are split into two pages (right and left).

When this option is set to [ON], you can specify the scan range for double-spread pages.

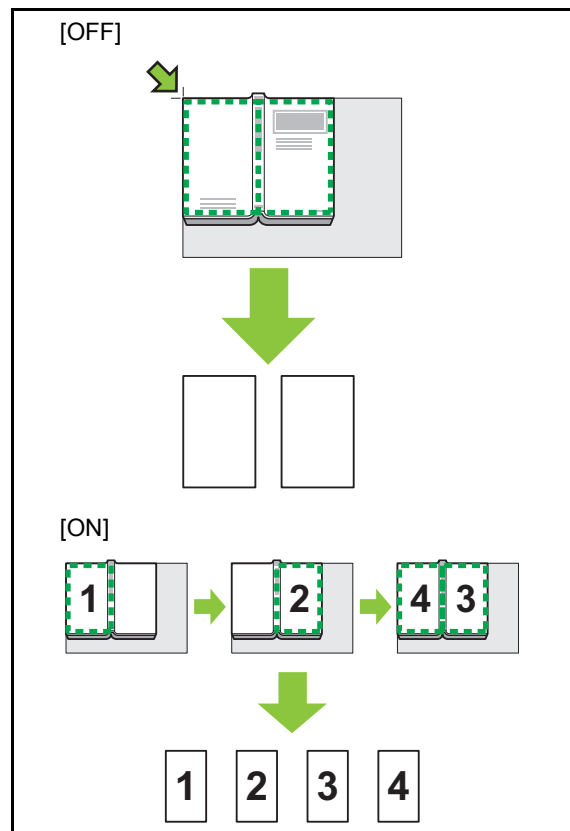

How to set up a page split is explained below using an example of setting [Page Selection while Scanning] to [ON].

1 Touch [Page Split].

The [Page Split] screen is displayed.

2 Specify the page order.

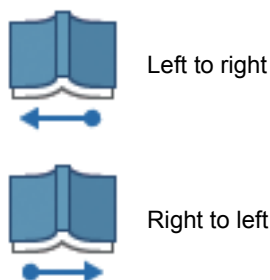

3 Set [Page Selection while Scanning] to [ON].

4 Touch [OK].

5 Press the [Start] key.

The scan range setting screen is displayed.

6 Select one of the following: [Left Only], [Both Sides], or [Right Only].

7 Touch [Scan].

The scanning of the original starts.

Repeat steps 6 and 7 until all pages are scanned.

8 Touch [Scanned].

The printing of the scanned data starts.

Combine

This function imposes continuous pages onto one sheet.

-  You cannot use [Combine] and [Mixed Size Original] at the same time. (p. 1-11 "Mixed Size Original")



[Pages/Sheet]

[OFF], [2 pages], [4 pages], [8 pages]

[Layout]

Specify the order of page imposition.

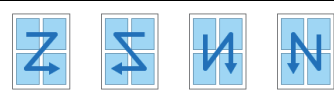
Example: Portrait document

Pages per sheet	Layout
2 pages	
4 pages	
8 pages	

[Original Orientation] (p. 1-9 "Original Orientation")

1 Touch [Combine].

The [Combine] screen is displayed.

- If the [Confirm] screen appears, set the original orientation to [Top Side Up] or [Top Side Left].

2 Specify the number of pages per sheet.

3 Select a layout.

4 Touch [OK].

Image Repeat

This function imposes multiple copies of the same original onto one sheet.



- You cannot use [Image Repeat] and [Mixed Size Original] at the same time. (p. 1-11 "Mixed Size Original")

[OFF], [2 pages], [4 pages], [8 pages]

[Original Orientation] (p. 1-9 "Original Orientation")

1 Touch [Image Repeat].

The [Image Repeat] screen is displayed.

- If the [Confirm] screen appears, set the original orientation to [Top Side Up] or [Top Side Left].

2 Select the number of pages per sheet.

3 Touch [OK].

Booklet

This function is used for duplex printing of continuous pages imposed onto one sheet.

- You cannot use [Booklet] with [Mixed Size Original] or [Combine]. (p. 1-11 "Mixed Size Original", p. 1-13 "Combine")

<Types of paper that can be used to create booklets>
A3, B4, A4, Ledger, Legal, Letter, Foolscap and custom size*

* The administrator must register the paper size in advance. Contact your administrator.

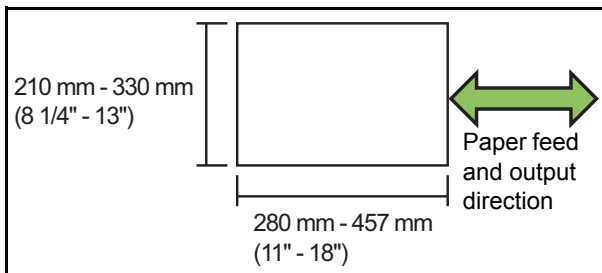

[Layout Order]

Specify the imposition order.

When this option is set to [OFF], the imposition function is not available.

[Center Margin]

Set the center margin to the center of folded sections to prevent the folded sections from hiding when the sheets are folded in two.

[Auto Reduction]

Set this option to [ON] to enable automatic reduction.

1 Touch [Booklet].

The [Booklet] screen is displayed.

2 Select the layout order.

3 Touch [↓] or [↑] to specify the center margin.

You can also enter the number using the numeric keys.

4 Select [Auto Reduction].

5 Touch [OK].



- If the center margin you have specified causes the printed image not to fit on the sheet, set the automatic reduction to [ON].

Stamp

This function prints the page number and date on the header or footer.



- The page number and date cannot be stamped on slip sheet paper or cover paper. (p. 1-21 "Separation", p. 1-20 "Add Cover")
- When using this function with [Combine] or [Image Repeat], the page number and date are stamped on each page of the copy paper, not per page of the original. When using this function with [Booklet], the page number and date are stamped on each booklet page.
- Specifying the reproduction size does not affect the stamp size of the page number and date.
- The [Stamp] and [Page Border] functions cannot be used at the same time. (p. 1-16 "Page Border")

[Page], [Date]

[OFF]

Page and date are not printed.

[Print Position]

Specify the print position.

[Text Size]

Specify the text size for printing.

[Transparency]

When this option is set to [OFF], images are removed from the stamp area to create a white space, and the text is stamped in that white space.

When this option is set to [ON], the text is stamped over an image when the stamp area and an image overlap.

[Start Number]

Specify the first number to stamp.

[Stamp Start Page]

Specify the first page to be stamped.

Example: When the stamp start page is set to "2" and the stamp start number is set to "3"

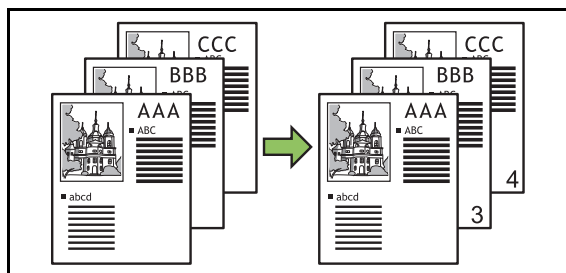

[Apply Page]

When this option is set to [All Pages], the stamp is applied to all pages.

When this option is set to [First Page Only], the stamp is applied only to the first page.

[Stamp Date]

When this option is set to [Today], today's date (the date set on the machine) is stamped.

When this option is set to [Specify Date], the specified date is stamped.

Stamping the Page Number

1 Touch [Stamp].

The [Stamp] screen is displayed.

2 Touch [Page].

3 Specify the print position.



• The page number and date cannot be stamped together in the same position.

4 Specify the text size.

Touch [▽] or [△] to specify the text size on the [Text Size] screen. You can also enter the number using the numeric keys.

5 Set the transparency option.

6 Specify the start number.

7 Specify the stamp start page.

8 Touch [OK].

Stamping the Date

1 Touch [Stamp].

The [Stamp] screen is displayed.

2 Touch [Date].

3 Specify the print position.



• The page number and date cannot be stamped together in the same position.

4 Specify the text size.

Touch [▽] or [△] to specify the text size on the [Text Size] screen. You can also enter the number using the numeric keys.

5 Set the transparency option.

6 Set the apply page option.

7 Set the date to be stamped.

To stamp a date of your choice, touch [▽] or [△] on the [Specify Date] screen to specify the stamp date.

You can also enter the number using the numeric keys.

8 Touch [OK].

Page Border

This option adds a border line in the margins of the paper.



- Even when this option is used with [Combine] or [Image Repeat], the border line is printed on each copy paper, not per page of the original.
- The border lines are printed over the original data. If there is an overlap of an image in the border printing area, part of the image may not be printed.
- When [Color Mode] is set to [Black], [Cyan], or [Magenta], colors that are not selectable are grayed out. (p. 1-7 "Color Mode")
- Printing a border on black-and-white copies can make posters and signs stand out.
- You cannot use [Page Border] with [Stamp] or [Mixed Size Original]. (p. 1-14 "Stamp", p. 1-11 "Mixed Size Original")

[OFF], [Red], [Blue], [Green], [Yellow], [Black]
Border line width (manual entry)

1 Touch [Page Border].

The [Page Border] screen is displayed.

2 Select a border line color.

3 Touch [⊖] or [⊕] to specify the width of the border line.

You can also enter the number using the numeric keys.

4 Touch [OK].

Image Quality

Specify the resolution for scanning originals.

[Standard]

Select this when the original has mostly text.

[Fine]

Select this when the original has photos. The original is scanned with higher resolution.

1 Touch [Image Quality].

The [Image Quality] screen is displayed.

2 Select a resolution.

3 Touch [OK].

Original Type

Select an original type to print the original using appropriate image processing.

[Line/Photo]

Select this when the original has both text and photos.

[Line]

Select this when the original has text or illustrations.

[Photo]

Select this when the original has photos.

[Map/Pencil]

Select this for originals with a lot of subtle colors or fine lines, such as a map, or for originals with pencil drawings.

[Dot Process]

When this option is set to [OFF], the dot process function is disabled.

When this option is set to [70 lpi], photos are reproduced with a printing resolution of 70 lpi.

When this option is set to [100 lpi], photos are reproduced with a printing resolution of 100 lpi.

1 Touch [Original Type].

The [Original Type] screen is displayed.

2 Select an original type.

3 If [Line/Photo], [Photo], or [Map/Pencil] is selected, set the dot process option.

4 Touch [OK].

Gamma Correction

This function adjusts the color balance (CMYK) of the scanned data.



- When [Color Mode] is set to [Black], [Cyan], or [Magenta], the gamma value can only be adjusted for black (K). (p. 1-7 "Color Mode")

[C] - [R]

[1], [2], [3], [4], [5], [6], [7]

The lower the value (lowest being [1]), the stronger the cyan (C) is in the image. The higher the value (highest being [7]), the stronger the red (R) is in the image.

[M] - [G]

[1], [2], [3], [4], [5], [6], [7]

The lower the value (lowest being [1]), the stronger the magenta (M) is in the image. The higher the value (highest being [7]), the stronger the green (G) is in the image.

[Y] - [B]

[1], [2], [3], [4], [5], [6], [7]

The lower the value (lowest being [1]), the stronger the yellow (Y) is in the image. The higher the value (highest being [7]), the stronger the blue (B) is in the image.

[K]

[1], [2], [3], [4], [5], [6], [7]

The higher the value (highest being [7]), the stronger the black (K) is in the image.

1 Touch [Gamma Correction].

The [Gamma Correction] screen is displayed.

2 Select the balance for each color.

[Output Image] displays a preview of the image with the adjusted color balance.

3 Touch [OK].

Image Control

Specify the appropriate image processing settings for the scanned data.

[Auto]

The values are automatically configured based on the [Color Mode] and [Original Type] settings. (p. 1-7 "Color Mode", p. 1-16 "Original Type")

[Line/Photo Level]

[1], [2], [3], [4], [5], [6], [7]

The higher the value (highest being [7]), the higher the text recognition level applied is (even text with unclear outlines is recognized as text).

[Edge Enhancement]

[1], [2], [3], [4], [5], [6], [7]

The higher the value (highest being [7]), the greater the edge emphasis is for parts recognized as text.

[Moire Elimination]

[1], [2], [3], [4], [5], [6], [7]

The higher the value (highest being [7]), the greater the reduction of moire is for parts recognized as a photo.

1 Touch [Image Control].

The [Image Control] screen is displayed.

2 Set the image control settings.

3 Touch [OK].

Base Color Level

This function makes the background color (base color) lighter so that the text is easier to read when copying text originals with a background color or originals printed on colored paper.

[1], [2], [3], [4], [5], [6], [7]

The higher the value, the more the background color level is reduced.

[Auto]

The density of the background color is set automatically.

1 Touch [Base Color Level].

The [Base Color Level] screen is displayed.

2 Configure the base color level settings.

3 Touch [OK].

Image Position

This function adjusts the printing position of images.

[Front Side], [Back Side]

Select which side to adjust the image position for.

[Reset]

Select this option to return the adjusted value for the selected side (front or back side) to 0 mm.

[↶], [↷], [↵], [↷]

Use these keys to move the position of images.

1 Touch [Image Position].

The [Image Position] screen is displayed.

2 Select the side to adjust the image position for (front or back side).

3 Touch [↶], [↷], [↵], and/or [↷] to adjust the image position.

4 Touch [OK].



- You can adjust the printing position a maximum of ± 20 mm (13/16") up, down, left, or right, in increments of 0.5 mm (0.02").
- When performing duplex printing, the front and back sides can be adjusted separately.

Program

This option is convenient when the number of required copies varies by group (such as corporate division or classes).

You can program settings for the number of copies and sets, sorting, slip sheets, and other options for each group. This enables you to quickly print exactly the number of copies of the number of sets you need.



- This option cannot be used with the [Sort] or [Separation] function. (p. 1-10 "Sort", p. 1-21 "Separation")
- You can configure up to 60 groups.

Examples of Entering the Number of Copies and Sets

- You can enter up to 9,999 copies and up to 99 sets. For example, to distribute a leaflet to the parents of all first-grade students in school, you can use the [Program] function to print the necessary number of copies for each class with a single copy job.

	Class 1	Class 2	Class 3	Class 4	Class 5	Class 6
No. of students	35	33	35	30	32	33

To print the leaflets by group, configure the settings as follows.

	Class 1	Class 2	Class 3	Class 4	Class 5	Class 6
No. of copies × No. of sets	35 × 1	33 × 1	35 × 1	30 × 1	32 × 1	33 × 1

Even if two classes have the same number of students (such as Classes 1 and 3 or Classes 2 and 6), you can configure the settings as follows to output the number of copies per class.

	Classes 1 and 3	Classes 2 and 6	Class 4	Class 5
No. of copies × No. of sets	35 × 2	33 × 2	30 × 1	32 × 1

■ About the Separation Settings

[Sort]

Set the [Sort] option to [Uncollated] to copy by page.

Set to [Collated] to make copies in sets.

[Slip Sheet]

When this option is set to [OFF], slip sheets are not inserted.

When this option is set to [Between Sets], a slip sheet is inserted between each set.

When this option is set to [Between Groups], a slip sheet is inserted between each group.

[Paper]

Specify the paper tray in which slip sheets are loaded.

[Number Printing]

Set this option to [ON] to print numbers.

The group number and set number are printed when this option is set to [Between Sets], and only the group number is printed when this option is set to [Between Groups].

Saving a Program

You can register up to 12 programs and call them whenever necessary.

1 Touch [Program].

The [Program] screen is displayed.

2 Touch [No Entry], and then touch [Edit].

The program edit screen is displayed.

3 Enter the number of copies and sets using the numeric keys.

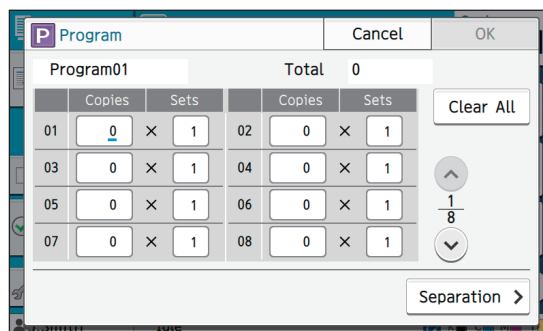

4 Touch [Separation].

The separation screen is displayed.

5 Set the sort and slip sheet options.

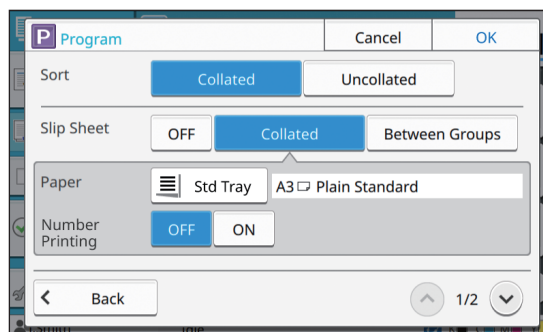

Set the [Paper] and [Number Printing] options as well if necessary.



- If you are using the optional face down finisher, the [Offset Output] function is also available. For more information, see "Offset Output ([Program])" (p. 8-7) in "Optional Equipment".

6 Touch [OK].

The [Confirm] screen is displayed.

7 Select [Overwrite] or [Register As].

To save by giving it a name, enter a program name and touch [OK].

The registration is now complete.

8 Touch [OK].

Retrieving a Program

You can call a saved program.

1 Touch [Program].

The [Program] screen is displayed.

2 Select the program to call.

The registered number of copies and sets are displayed in a list.

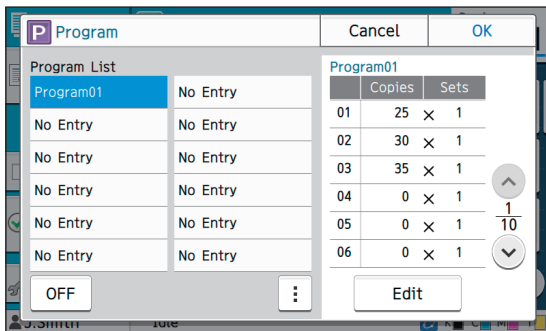

3 Touch [OK].

Changing the Program Settings

You can change a saved program.

1 Touch [Program].

The [Program] screen is displayed.

2 Select a program.

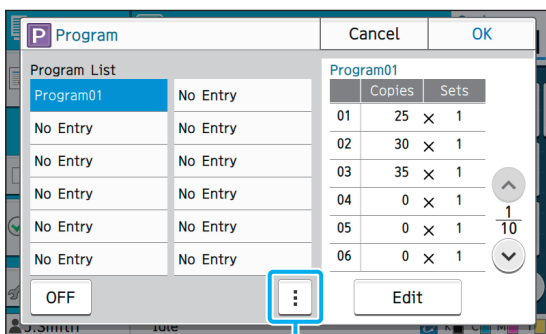

Sub menu

The following settings can be configured from the sub menu.

- Rename
- Delete

Follow the on-screen instructions to change the settings.

3 Touch [Edit].

For specific instructions on subsequent operations, see steps 3 through 8 in "Saving a Program" (p. 1-19).

Add Cover

You can load printed paper or colored paper into a paper tray to add to the front and back of the printed document as a cover.



- You cannot use paper of a different size from that of the copy paper.

[Binding Edge]

Specify the binding edge.

[Front Cover]

Set this option to [ON] to add a cover to the front of each printout.

[Back Cover]

Set this option to [ON] to add a cover to the back of each printout.

[Paper Tray]

Specify the feed tray that is loaded with cover paper.

1 Touch [Add Cover].

The [Add Cover] screen is displayed.

2 Select the binding side.

3 Configure the cover settings.

Select [OFF] or [ON] for the front and back covers.

4 Touch the paper tray.

The [Select Tray] screen is displayed.

5 Select a paper tray and touch [OK].

6 Touch [OK].

7 Load the cover paper.



- The side in which the paper is loaded varies depending on the tray.
Standard tray: Load the paper with the first page facing up.
Feed tray: Load the paper with the first page facing down.
See "Loading Paper" (p. 26).
- Change the [Paper Selection] settings according to the loaded paper. (p. 1-7 "Paper Selection")

Separation

Insert a slip sheet between pages or sets, or to separate jobs.



- To load special paper to be used as slip sheets, it is recommended that [Auto Selection] should be set to [OFF] for the paper tray for slip sheets. (p. 1-8 "Changing the Paper Tray Setting")

[Slip Sheet]

When this option is set to [OFF], slip sheets are not inserted.

When this option is set to [Between Sorts], a slip sheet is inserted for each unit specified in [Sort].

When this option is set to [After a Job], a slip sheet is inserted after every printed job.

[Paper]

Specify the paper tray in which slip sheets are loaded.

[Number Printing]

When this option is set to [OFF], numbers are not printed.

When this option is set to [1 2 3 ...], numbers are stamped on slip sheets in numerical order (1, 2, 3...).

When this option is set to [A B C ...], letters are stamped on slip sheets in alphabetical order (A, B, C ... Z, AA, AB...). (Up to ZZZ)

The text is printed at the bottom (within approx. 5 mm (7/32") of the edge) or top (within approx. 5 mm (7/32") of the edge) of the sheet.

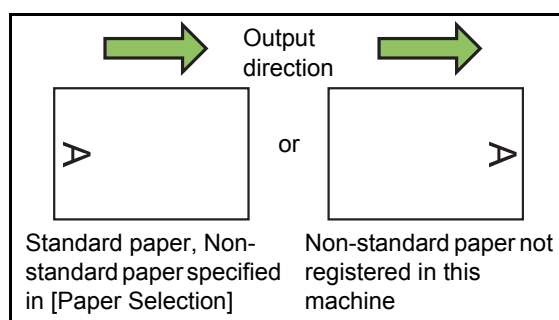

1 Touch [Separation].

The [Separation] screen is displayed.

2 Select the position where slip sheets are to be inserted.

3 Touch the paper tray.

The [Select Tray] screen is displayed.

4 Select the paper tray for slip sheets and touch [OK].

5 Configure the [Number Printing] setting.

6 Touch [OK].



- If you are using the optional face down finisher, the [Offset Output] function is also available. For more information, see "Offset Output ([Separation])" (p. 8-6) in "Optional Equipment".

Binding Margin

Specify the binding margin.

[Binding Edge]

Specify the binding edge.

Width

Enter the width using [▽], [△], or the numeric keys.

[Auto Reduction]

Set this option to [ON] to automatically reduce the image size to fit the image on the paper when part of the printing area is missing due to the binding margin setting.

1 Touch [Binding Margin].

The [Binding Margin] screen is displayed.

2 Specify the binding margin.

- Specify [Binding Edge].
- Enter the width using [▽], [△], or the numeric keys.
- If part of the printing area is missing due to the binding margin setting, set [Auto Reduction] to [ON].

3 Touch [OK].

Staple

If you are using the optional face down finisher, the staple function and the binding margin function are available.

For more information, see "Staple" (p. 8-6) in "Optional Equipment".

Slow Printing

This option slows down the printing speed as well as reduces the operating sound of the job being processed.

[OFF], [ON]

1 Touch [Slow Printing].

The [Slow Printing] screen is displayed.

2 Touch [ON].

3 Touch [OK].

Output Tray

If you are using the optional stacking tray, the [Output Tray] option is available.

For more information, see "Output Tray" (p. 8-11) in "Optional Equipment".

Output Tray Relay

If you are using the optional auto-control stacking tray, the [Output Tray Relay] option is available.

For more information, see "Output Tray Relay" (p. 8-11) in "Optional Equipment".

Paper Tray Relay

Use this option to automatically feed paper from a different tray with the same paper size and paper type when the selected tray runs out of paper.

[OFF], [ON]

1 Touch [Paper Tray Relay].

The [Paper Tray Relay] screen is displayed.

2 Touch [ON].

3 Touch [OK].

Auto Image Rotation

This rotates the image 90 degrees automatically when the orientations of the original and paper do not match, even if the paper size loaded in the tray matches the size of the loaded original. Normally, this setting is set to [ON].

Interrupt Copy

This function allows you to pause the job being printed to copy another document.



- The following functions are not available for interrupt copy.
[Program], [Slip Sheet], [Add Cover], [ADF Scan & Pause]
- The [Interrupt Copy] function is not available while a job using staple function or offset output function is being processed.

1 Press the [Interrupt] key.

The interruption screen is displayed.

2 Load the original and press the [Start] key.

- You can continue with the interruption copying while the [Ready to copy. (Interrupting)] message is displayed.

3 After the copying is completed, press the [Interrupt] key to cancel interrupt copy.

Printing of the paused job resumes.

- Interrupt copy is also canceled when the machine has not been operated for 60 seconds.

Copy Mode Function Buttons

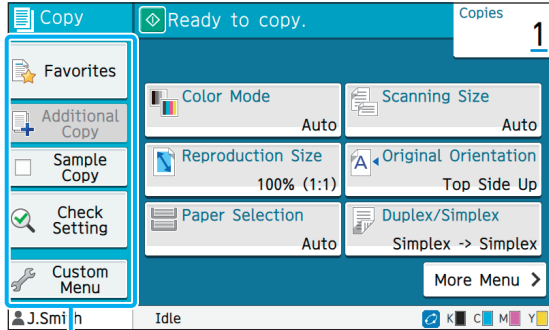

Function buttons

Favorites

Settings can be called whenever necessary. The recommended settings are pre-registered as favorites.

Registering frequently used settings can be useful. For more information, see "Adding as a Favorite" (p. 1-25).

1 Touch [Favorites].

The [Favorites] screen is displayed.

2 Select a favorites item.

Set values are shown in a list on the screen.

The following settings can be configured from the sub menu.

- Rename
- Delete

3 Touch [OK].



- You cannot rename or delete favorites that are registered as factory settings.

Additional Copy

This function prints out a copy of the original that was copied last. The original does not need to be scanned again.



- Additional Copy cannot be made in the following cases.
 - When the administrator has not permitted the use of the additional copy function
 - When auto reset has been executed after copying the original
 - When the user is logged out

1 Touch [Additional Copy] after the copy job is finished.

The [Additional Copy] screen is displayed.

2 Use the numeric keys to specify the number of copies.

3 Touch [OK].

Printing of additional copies starts.

Sample Copy

The printing stops after one copy has been printed. This function allows you to check the output before making a large number of printouts.



- If you set [Sort] to [Collated], you can use this function to make one copy as a sample. (p. 1-10 "Sort")

1 Touch [Sample Copy].

The [Sample Copy] screen is displayed.

2 Touch [ON].

3 Touch [OK].

4 Press the [Start] key.

The [Making sample copies] screen is displayed, and copying of the original starts. The current status is displayed on the screen.

- The copying can be paused with the [Stop] key. (p. 1-3 "Canceling Copying")
- Touch [Slow Printing] to slow down the printing speed. This also reduces the operating sound of the job being processed.

The [Confirm] screen appears after a sample copy is printed.

You can change the following settings.

- [Change Setting] (p. 1-3 "Changing the Settings During Copying")
- [Maintenance] (p. 1-4 "Performing Maintenance During Copying")

Check Setting

This function allows you to check the current settings.

1 Touch [Check Setting].

The [Check Setting] screen is displayed. Check the current settings.

The following settings can be configured from the sub menu.

- Add to Favorites
- Save as Default
- Print This List

2 Touch [Close].

Custom Menu

You can register favorites and default settings, and edit the button order.

Adding as a Favorite

Register the settings and the number of copies for a setting button as a favorite. You can register up to 30 favorites.

1 Touch [Custom Menu].

The [Custom Menu] screen is displayed.

2 Touch [Favorites Create/Edit].

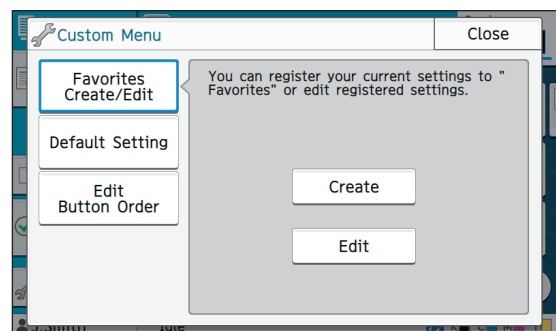

3 Touch [Create].

The [Add to Favorites] screen is displayed. Check the current settings.

4 Touch [OK].

5 Enter the registration name and touch [OK].

The settings are registered as a favorite.

6 Touch [Close].



- The following settings are not registered as a favorite.
- [Paper Selection]

Editing Favorites

You can change the display order of favorites.

1 Touch [Custom Menu].

The [Custom Menu] screen is displayed.

2 Touch [Favorites Create/Edit].

3 Touch [Edit].

The [Edit Favorites] screen is displayed.

4 Select one of the favorites.

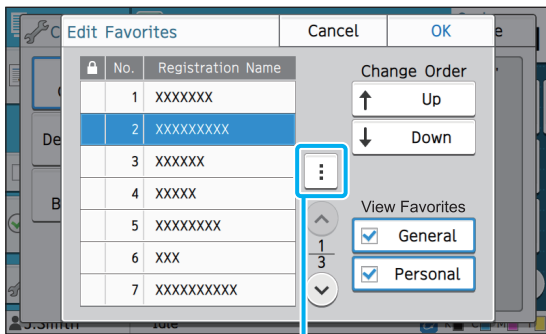

Sub menu

You cannot edit favorites with a lock icon.

The following settings can be configured from the sub menu.

- Check Setting
- Rename
- Delete

5 Touch [Up] or [Down] to set up the order.

6 Configure the [View Favorites] setting.

- When you select [Common], the common favorites and the favorites registered as factory settings are displayed.
- When you select [Personal], the personal favorites are displayed.
- When you select both [Common] and [Personal], the common favorites, the favorites registered as factory settings, and the personal favorites are displayed.



- [View Favorites] may not be displayed depending on the configuration by the administrator. In this case, the common favorites and the favorites registered as factory settings are displayed.

7 Touch [OK].

Saving as a Default

You can register the values and the number of copies set using the setting buttons as default settings.

1 Touch [Custom Menu].

The [Custom Menu] screen is displayed.

2 Touch [Default Setting].

3 Touch [Entry].

The [Save as Default] screen is displayed. Check the current settings.

4 Touch [OK].

The settings are registered as default settings.

5 Touch [Close].



- The following settings are not registered as default settings.
- [Paper Selection]

Clearing Defaults

This function returns the registered default values to those set by the administrator. (If the administrator has not registered the default values, the factory values are restored.)

1 Touch [Custom Menu].

The [Custom Menu] screen is displayed.

2 Touch [Default Setting].

3 Touch [Clear].

The [Initialize] screen is displayed.

4 Touch [OK].

The default values are cleared.

5 Touch [Close].

Editing Button Order

This function changes the arrangement of setting buttons.

1 Touch [Custom Menu].

The [Custom Menu] screen is displayed.

2 Touch [Edit Button Order].

The [Edit Button Order] screen is displayed.

3 Select one of the setting buttons.

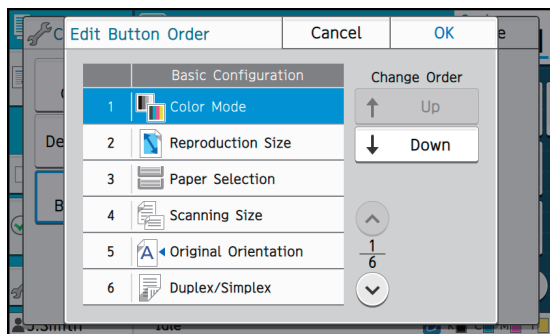

4 Touch [Up] or [Down] to set up the order.

5 Touch [OK].

The arrangement of the setting buttons is completed.

6 Touch [Close].

You can scan a paper original to digitize it.

Select the destination to save the scanned data to according to how you want to use the scanned image.

The scanned data can be saved to a computer on the network, sent via e-mail as an attachment, or saved to the internal hard disk of this machine for downloading from the RISO Console.

Overview of Scan Operations p. 2-2

1. Load the original.



2. Touch [Scan] on the [Home] screen.



3. Select an address or destination.



4. Change the settings.



5. Check the preview display.



6. Touch [Send].

Scan Settingsp. 2-6

This section explains each scan setting in detail.

Scan Mode Function Buttonsp. 2-10

This section explains the functions available in Scan mode.



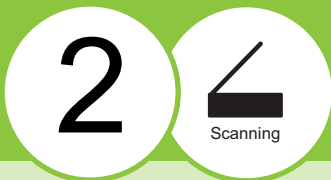

Scanning

Overview of Scan Operations

This section explains the basic scan operations.

Procedure

1 Load the original.

For more information on the types of originals that can be used, see "Originals" in the "Safety Information".



- The machine cannot scan the area within 1 mm (0.04") of the edge of the paper. (Any part of the image within this area will be lost.)

■ In the ADF

1 Load the original in the ADF.

Align the originals and place them face up.

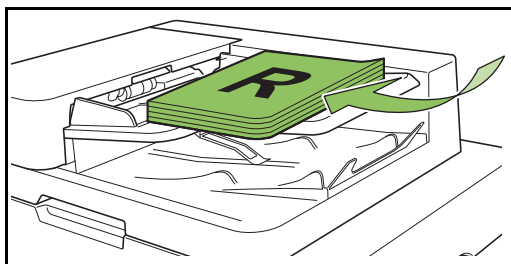

2 Slide the original guides to match the width of the originals.

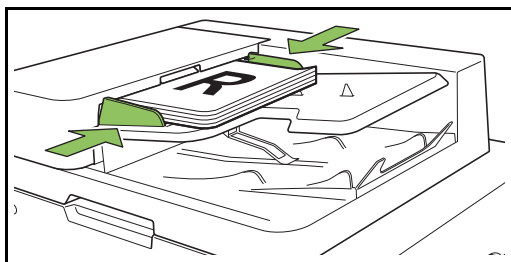

■ On the Platen Glass

1 Open the original cover.

2 Loading Originals

Load the original face down on the glass. Align the corner of the original with the upper-left corner of the glass.

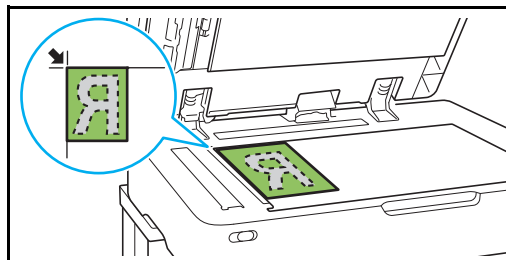

3 Close the original cover.



- Open and close the original cover gently.

2 Touch [Scan] on the [Home] screen.

Select [Mail], [PC], or [Console].

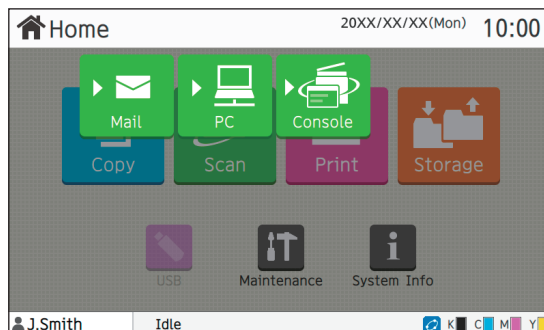

3 Select an Address/ Destination.

If you select [Mail] or [PC], specify the address/
destination for the scanned data.



- If you select [Console], you do not need to specify the destination. The scanned data is saved to the internal hard disk of this machine.

■ When you have selected [Mail]

You can attach the scanned data to e-mail messages
and send them.

1 Touch [Address].

The [Address] screen is displayed.

2 Select an address from [Mail Address Book].

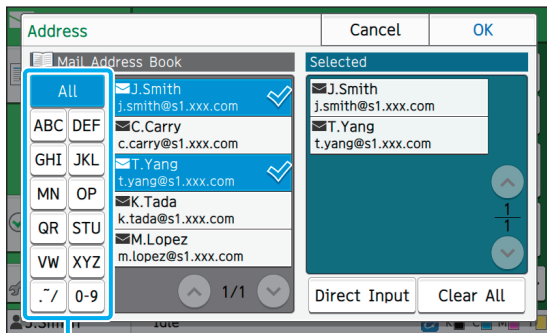

Index

The selected address appears in [Selected].

- You can touch the index to narrow down the list of addresses registered in the address book.

3 Touch [OK].



- To send to an address that is not displayed in [Mail Address Book], touch [Direct Input] to register a new address.
- To remove an address from [Selected], you can either clear all addresses by touching [Clear All] or select the address to remove and touch [Clear].
- Touch [Sender] to display the [Sender] screen and enter the sender's name.

■ When you have selected [PC]

The scanned data is saved on a computer on the
network.

1 Touch [Destination].

The [Destination] screen is displayed.

2 Select a destination from [PC Address Book].

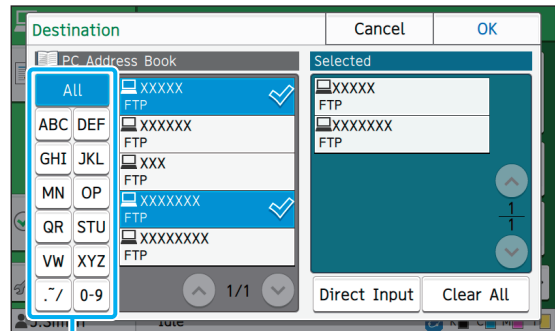

Index

The selected destination appears in [Selected].

- You can touch the index to narrow down the list of destinations registered in the address book.

3 Touch [OK].



- To save data to a computer not listed in [PC Address Book], contact your administrator.
- Touch [Direct Input] to register a new destination. For more information on the destination server, contact your administrator.

● 4 Change the settings.

Specify the detailed settings for scanning. For more information on the functions that can be configured, see "List of Settings" (p. 2-5).

● 5 Check the preview display.

1 Touch [Check Setting].

The [Check Setting] screen is displayed.

2 Touch [Preview].

The scanning of the original starts, and the preview is displayed.

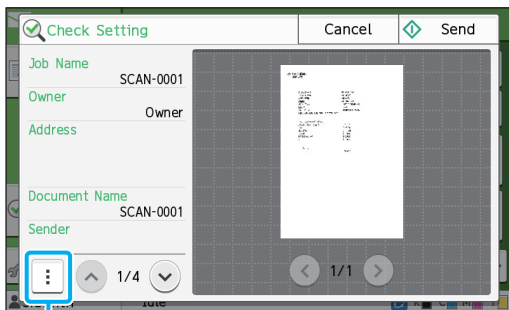

Sub menu

To switch pages, touch [◀] or [▶].

The following settings can be configured from the sub menu.

- Change Address

● 6 Touch [Send].

The [Scanning] screen is displayed, and scanning of the original starts. The current status is displayed on the screen.

- After the [Confirm] screen is displayed, touch [Close].
The original is scanned and saved.

■ To cancel scanning

1 Press the [STOP] key.

Scanning is stopped and the Scan screen is displayed.



- When you select [Console] to scan data, the scanned data is saved to the internal hard disk of this machine. The saved data can be downloaded to a user's computer using the RISO Console. See "[Scan] Menu Screen" (p. 6-9) in "RISO Console".

- The storage period for the scanned data is configured by the administrator.



- RISO KAGAKU CORPORATION is not responsible for the loss of any data on the machine's internal hard disk that may occur during the use of this machine. For data protection, it is recommended to back up data in advance.

List of Settings

The following is a list of settings available in Scan mode.

Setting item	Description	See
Document Name	View and specify the document name when saving the scanned data.	p. 2-6
Color Mode	Specify the color mode of the data to be scanned.	p. 2-7
Scanning Size	Specify the scanning size for originals to be scanned.	p. 2-7
File Format	Specify the file format for saving the scanned data.	p. 2-7
Duplex / Simplex	Specify the sides of the original to be scanned.	p. 2-8
Scanning Level	Adjust the scanning level.	p. 2-8
Original Orientation	Specify the orientation of the original.	p. 2-8
Resolution	Specify the resolution for scanning originals.	p. 2-8
Mixed Size Original	Use this option when multiple different original sizes are used in the original.	p. 2-8
Book Shadow Erasure	Use this option to remove shadows that appear in the center of images when an open book is scanned.	p. 2-8
Page Split	Use this option to scan double-spread pages and split them into two parts (right and left).	p. 2-8
PIN Code	Assign PIN codes when saving scanned jobs on the internal hard disk of this machine.	p. 2-9
Original Type	Select the original type to perform the appropriate image processing and save the scanned data.	p. 2-9
Gamma Correction	Use this option to correct the color balance (CMYK) of the scanned data.	p. 2-9
Image Control	Specify the image processing appropriate for the original.	p. 2-9
Base Color Level	Make the background color (base color) lighter so that the text is easier to read.	p. 2-9
Favorites	Call frequently used settings.	p. 2-10
Check Setting	Use this option to check the current settings. You can check the preview of the scanned data.	p. 2-10
Custom Menu	Register favorites and default settings, and edit the button order. You can register and edit the address books as well.	p. 2-10

Scan Settings

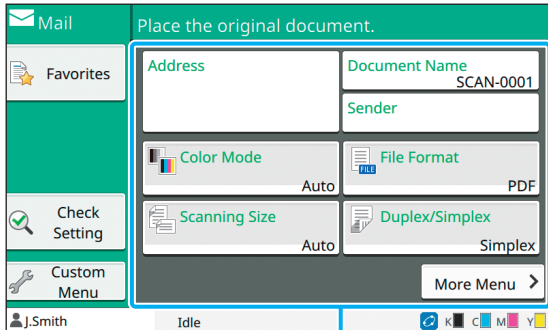

Setting buttons

Document Name

You can view the document name to be used when saving the scanned data.

Touch [Document Name] to set the document name.

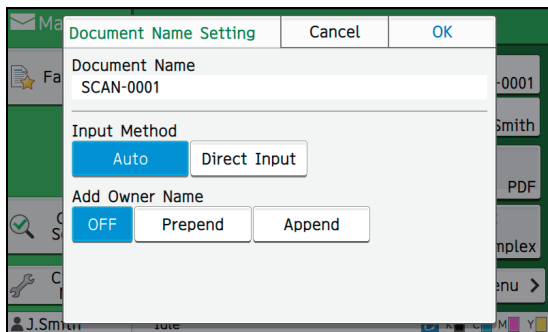

[Document Name]

Among the information specified in [Input Method] and [Add Owner Name], the [Document Name] and [Owner] information is displayed.

[Input Method]

Select [Auto] to set the document name automatically. Select [Direct Input] to enter a document name of your choice.

If you select [Auto], a document is named with a serial number (0001 to 9999) given following "SCAN-" as the default setting.

[Add Owner Name]

Specify whether to add the owner's name to the document names set up in [Input Method].

Select [OFF] to not add the owner's name.

Select [Prepend] to add the owner's name before document names and name them using the following format:

Owner's name - Document name - Page number_Serial number.extension

Example: J.Smith-SCAN-0001-1_0001.tif

Select [Append] to add the owner's name after document names and name them using the following format:

Document name - Owner's name - Page number_Serial number.extension

Example: SCAN-0001-J.Smith-1_0001.tif



- The serial number is added only when duplication of a file name occurs.

1 Touch [Document Name].

The [Document Name Setting] screen is displayed.

2 Select an option for [Input Method].

3 Select whether to print the owner's name.

4 Touch [OK].



- For more information on text input, see "Entering Text" (p. 24).
- For [Direct Input], you can use upper and lower case letters.

Color Mode

Select the color mode of the data to be scanned.

[Auto]

The machine automatically determines if the original is in color or black and white. If it is determined that the original is in color, it is converted to RGB data and saved. If it is determined that the original is in black and white, it is converted to black data and saved.

[Full Color]

Originals are converted to RGB data and saved.

[Grayscale]

Color originals or color photos are converted to grayscale data and saved.

[Black]

Originals are saved as black and white (binary) data.

1 Touch [Color Mode].

The [Color mode] screen is displayed.

2 Select the color mode.

3 Touch [OK].

Scanning Size

Specify the size of the original to be scanned.

For more information, see "Scanning Size" (p. 1-9) in "Copy".

File Format

Specify the file format for saving the scanned data.

[PDF], [TIFF], [JPEG], [PDF/A]

File format	Setting item
[PDF]	[Image Quality] [PDF Password] [Single Page] [ZIP]
[TIFF]	[ZIP]
[JPEG]	[Image Quality] [ZIP]
[PDF/A]	[Image Quality]

[Image Quality]

[1: Low], [2], [3], [4], [5: High]

[PDF Password]

Enter the user password and owner password from [Details].

[Single Page]

Select [ON] to save the scanned data in single pages.

[ZIP]

This option appears when sending the scanned data via e-mail or sending the scanned data to a computer on the network. Select [ON] to compress the scanned data into a zip file.



- When saving the scanned data to the internal hard disk of this machine, the scanned data is compressed into a zip file.

1 Touch [File Format].

The [File Format] screen is displayed.

2 Select the file format to use for saving the scanned data.

3 Change the settings as needed.

4 Touch [OK].



- If the scanned data is only one file, the scanned data will not be compressed.
- If [File Format] is set to [PDF], the [ZIP] option will become available when [Single Page] is set to [ON].
- [User Password] that can be entered when [PDF] is selected as the file format is necessary to open the documents later. [Owner Password] is necessary to set the access rights to documents, specifically, the permission to print and edit.
The [PIN code] (p. 2-9) for this machine is different from the passwords mentioned above; the PIN code serves the purpose of protecting the scan jobs to be saved in the internal hard disk and the print jobs sent from a computer.

Duplex / Simplex

Specify the sides of the original to be scanned.

[Single-sided], [Double-sided]

[Paging Direction]

Specify whether pages are opened right/left or top/bottom.

[Original Orientation] (p. 2-8 "Original Orientation")

1 Touch [Duplex/Simplex].

The [Duplex/Simplex] screen is displayed.

2 Touch [Original Orientation].

Select [Top Side Up] or [Top Side Left].

3 Specify the sides of the original to scan.

If you have selected [Double-sided], specify the paging direction.

4 Touch [OK].

Scanning Level

Adjust the scanning level.

For more information, see "Scanning Level" (p. 1-10) in "Copy".

Original Orientation

Specify the orientation of the original.

For more information, see "Original Orientation" (p. 1-9) in "Copy".

Resolution

Specify the resolution for scanning originals.

[200dpi], [300dpi], [400dpi], [600dpi]

1 Touch [Resolution].

The [Resolution] screen is displayed.

2 Specify the resolution.

3 Touch [OK].

Mixed Size Original

Use this option when multiple different original sizes are used in the original. The sizes that can co-exist are "A4-LEF and A3", and "B5-LEF and B4".

For more information, see step 2 and subsequent steps under "Mixed Size Original" (p. 1-11) in "Copy".

Book Shadow Erasure

Remove shadows that appear in the center of images when an open book is scanned.

For more information, see "Book Shadow Erasure" (p. 1-12) in "Copy".

Page Split

Use this option to scan double-spread pages and split them into two parts (right and left).

For more information, see "Page Split" (p. 1-12) in "Copy".

PIN Code

Assign PIN codes when saving scanned jobs on the internal hard disk of this machine. The PIN code set here is required when using the RISO Console to download to a computer.

[OFF], [ON]

Enter value (8 digits or less)

1 Touch [PIN code].

The [PIN code] screen is displayed.

2 Touch [ON].

3 Use the numeric keys to enter the PIN code.

4 Touch [OK].

Original Type

Select the original type to perform the appropriate image processing for saving the scanned data.

[Line/Photo]

Select this when the original has both text and photos.

[Line]

Select this when the original has text or illustrations.

[Photo]

Select this when the original has photos.

1 Touch [Original Type].

The [Original Type] screen is displayed.

2 Select the original type.

3 Touch [OK].

Gamma Correction

Correct the color balance of the scanned data. For more information, see "Gamma Correction" (p. 1-17) in "Copy".



- When [Color Mode] has been set to [Grayscale] or [Black], the gamma value can only be adjusted for K. The gamma value cannot be corrected for C-R, M-G, or Y-B. (p. 2-7 "Color Mode")

Image Control

Specify the image processing appropriate for the original.

For more information, see "Image Control" (p. 1-17) in "Copy".

Base Color Level

This function makes the background color (base color) lighter so that the text is easier to read when scanning text originals with a background color or originals printed on colored paper.

For more information, see "Base Color Level" (p. 1-18) in "Copy".

Scan Mode Function Buttons

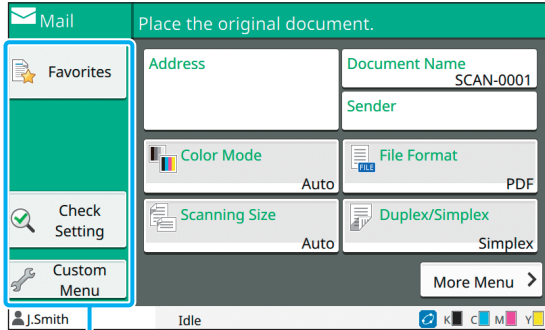

Function buttons

Favorites

Settings can be called whenever necessary. The recommended settings are pre-registered as favorites. Registering frequently used settings can be useful.

For more information, see "Favorites" (p. 1-24) in "Copy".

Check Setting

Use this option to check the current settings.

1 Touch [Check Setting].

Check the current settings.

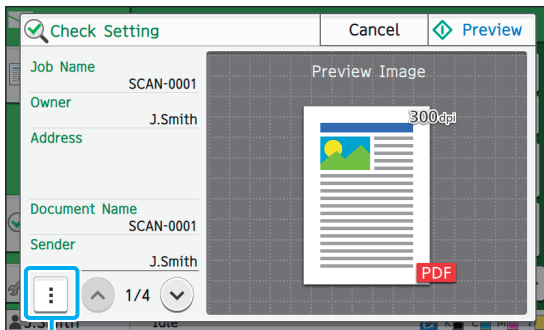

Sub menu

The following settings can be configured from the sub menu.

- Add to Favorites
- Save as default
- Print This List

Touch [Preview] to check the scanned image before sending the data.

2 Touch [Cancel].

To scan the original using the settings that you viewed, touch [Send] or [Save].

Custom Menu

You can register favorites and default settings, and edit the button order. You can register and edit the address books as well.

Adding as a Favorite / Editing Favorites

Use this function to register the settings configured with setting buttons as a favorite. You can register up to 30 favorites.

For more information, see "Adding as a Favorite" (p. 1-25) and "Editing Favorites" (p. 1-26) in "Copy".



- The following settings are not registered as a favorite.
 - [Document Name], [PDF Password] in [File Format], [PIN code]

Adding to the Address Book

You can register addresses and destinations in address books.

■ When you have selected [Mail]

1 Touch [Custom Menu].

The [Custom Menu] screen is displayed.

2 Touch [Address Book Add/Edit].

The [Address Book Add/Edit] screen is displayed.

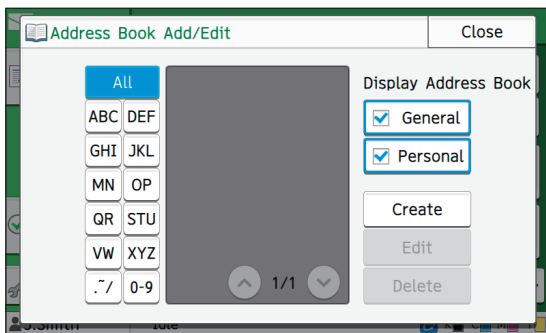

3 Touch [Create].

The [Create] screen is displayed.

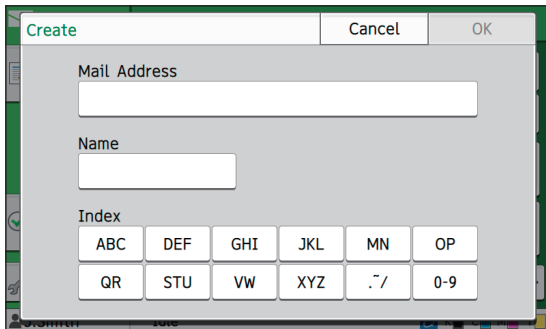

4 Enter an e-mail address.

5 Enter the name of the recipient.

6 Specify the index.

7 Touch [OK].

The e-mail address is registered in the address book.

8 Set the [Display Address Book] option.

Specify whether to show a common recipient or an individual recipient on the address book.

9 Touch [Close].

■ When you have selected [PC]

Register a computer as a scanned data destination.

For more information, see "Scan Data Directory" in the separately provided "Administrator's Guide".

Editing the Address Book

You can edit the personal addresses and destinations registered in the address books.

■ When you have selected [Mail]

1 Touch [Custom Menu].

The [Custom Menu] screen is displayed.

2 Touch [Address Book Add/Edit].

The [Address Book Add/Edit] screen is displayed.

3 Select an e-mail address and touch [Edit].

The [Edit] screen is displayed.

4 Change the settings.

5 Touch [OK].

The e-mail address settings are changed.

6 Touch [Close].

■ When you have selected [PC]

Change the settings registered as a scanned data destination.

For more information, see "Scan Data Directory" in the separately provided "Administrator's Guide".

Deleting an Address / Save Destination

You can delete personal addresses and destinations from address books.

■ When you have selected [Mail]

1 Touch [Custom Menu].

The [Custom Menu] screen is displayed.

2 Touch [Address Book Add/Edit].

The [Address Book Add/Edit] screen is displayed.

3 Select an e-mail address and touch [Delete].

The [Confirm] screen is displayed.

4 Touch [OK].

The e-mail address is deleted from the address book.

5 Touch [Close].

■ When you have selected [PC]

Delete the destination that you registered as a scanned data destination.

For more information, see "Scan Data Directory" in the separately provided "Administrator's Guide".

Saving / Clearing Defaults

You can register the values entered using the setting buttons as default settings.

For more information, see "Saving as a Default" (p. 1-26) and "Clearing Defaults" (p. 1-27) in "Copy".



- The following settings are not registered as default settings.
 - [Document Name], [PDF Password] in [File Format], [PIN code]

Editing Button Order

This function changes the arrangement of setting buttons.

For more information, see "Editing Button Order" (p. 1-27) in "Copy".

Connect this machine and a computer to the network to use this machine as a printer.
By using the printer driver, you can send the print data to this machine from a computer.

Overview of Print Operations (Printer Driver) p. 3-2

1. Open the printer driver screen.



2. Change the settings.



3. Click [OK].



4. Click [Print] or [OK].

Overview of Print Operations (Print Mode).....p. 3-3

1. Touch [Print] on the [Home] screen.



2. Select a job.



3. Press the [Start] key.

Printer Driver Settings p. 3-9

This section explains each printer driver setting in detail.

Print Mode Function Buttons p. 3-29

This section explains the functions available in Print mode.



3



Print

Overview of Print Operations

This chapter describes the basic operations to use this machine as a printer.

Procedure From the Printer Driver

● 1 Open the printer driver screen.

1 Select the print option in the application on the computer.

The print dialog box is displayed.

2 Check the printer name and click [Properties] or [Details].

The button names are different depending on the application.

● 2 Change the settings as needed.

For more information on the settings that can be configured, see "List of Settings" (p. 3-6).

- To restore all settings on the printer driver screen to their default values, click [Restore Default].



- The [Original Type] and [Paper Type] settings of the printer driver greatly affect the print quality. Change the settings according to use conditions.

● 3 Click [OK].

The print dialog box is displayed.



- If the [Collate] check box in the print dialog box is selected, remove the check mark. To print by collating copies, set [Sort] in the [Basic] tab to [Collated].

● 4 Click [Print] or [OK].

The print data is sent to this machine.



- When using the external system link, all jobs received from the computers are displayed in [External System Job] on the [Print] screen of this machine. Jobs can be printed or deleted from here.

The [External System Job] function is displayed when [External System Link] is set to [ON] by the administrator.

For more information, see "External System Job" (p. 3-29).

Procedure From Print Mode

- Depending on the settings configured by the administrator, printing may be performed simply by logging in.

1 Touch [Print] on the [Home] screen.

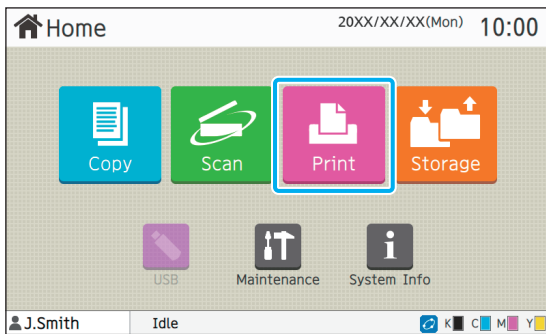

2 Select a job.

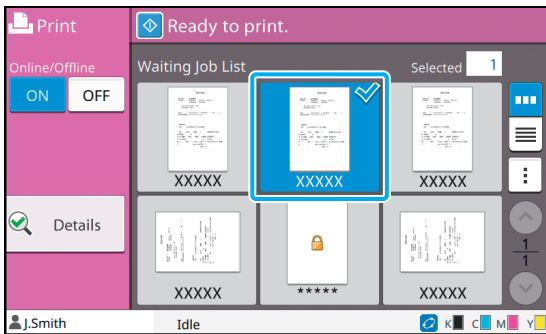

Icon displayed on thumbnails

- 🔒 : Job with a PIN code
- 📄 : Broken job (Broken data or data with problems)
- None:** All other jobs sent from computers

The following settings can be configured from the sub menu.

- Change Setting
- Delete

- When a job name exceeds the character limit, the first half of the job name is omitted and displayed as "...".
- In the following cases, the job name is displayed as "*****".
 - Jobs with the [Hide Job Name] check box selected on the printer driver (p. 3-24 "PIN Code")
 - Jobs that belong to users other than the user currently logged in when [Job Name Display] is set to [OFF] on the administrator menu

3 Press the [Start] key.

The selected job is printed.

When printing a job with a PIN code

The PIN code entry screen is displayed. Enter the PIN code using the numeric keys, and touch [Continue].

3

Changing Settings During Printing

1 Press the [Stop] key.

The [Suspending] screen is displayed.

2 Touch [Change Setting].

The [Change Setting] screen is displayed.

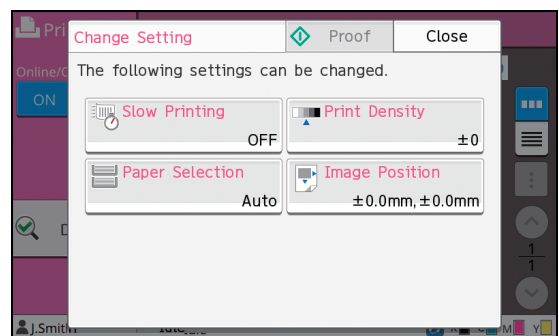

3 Change Settings.

You can change the following settings.

- Slow Printing (p. 1-22 "Slow Printing")
- Print Density (p. 1-10 "Print Density")
- Paper Selection (p. 1-7 "Paper Selection")
- Image Position (p. 1-18 "Image Position")



- If you touch [Proof], only one copy of the page that was being processed when the [Stop] key is pressed is printed.

4 Touch [Close].

5 Touch [Continue].

Printing of the job with modified settings starts.

Performing Maintenance During Printing

1 Press the [Stop] key.

The [Suspending] screen is displayed.

2 Touch [Maintenance].

The [Maintenance] screen is displayed.

3 Change Settings.

You can change the following settings.

- Head Cleaning
- Paper Guide Control
- Online/Offline
- Front Cover Release



- Touch [Online/Offline] to display the [Online/Offline] screen. You can monopolize the printer by disconnecting it from the network.
- For more information on [Head Cleaning] and [Front Cover Release], see the separately provided "Troubleshooting Guide".
- If you touch [Proof], only one copy of the page that was being processed when the [Stop] key is pressed is printed.
- If you are using the optional auto-control stacking tray, you can adjust the position of the stacking tray from [Paper Guide Control]. For more information, see the separately provided "Troubleshooting Guide".

4 Touch [Close].

5 Touch [Continue].

Printing of the job with modified settings starts.

Printer Driver Screen

Settings can be configured from the printer driver screen.

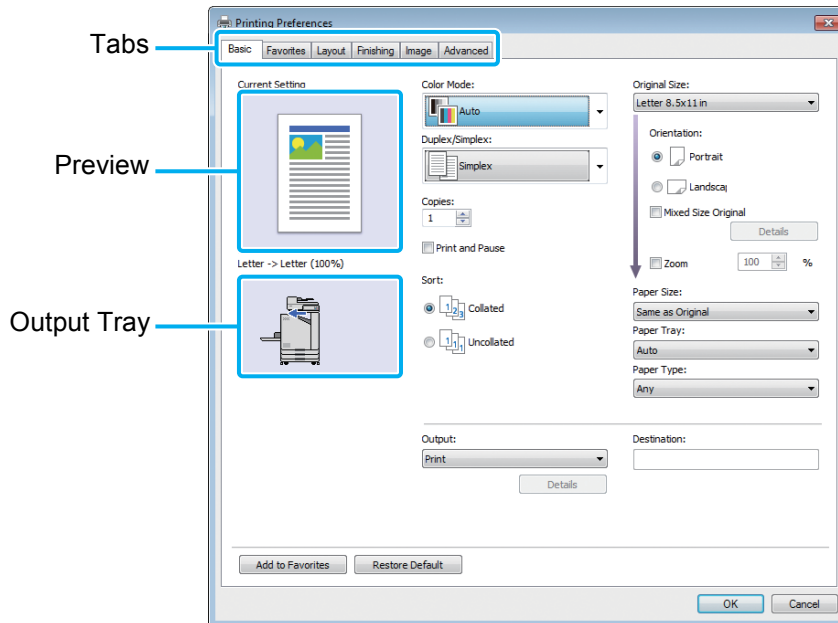

- Tab: Click a tab to switch the screen.
- Preview: Displays a preview image of the document to be printed. The original size, paper size, and enlarge/reduce percentage are displayed under the image.
- Output tray: The output tray is shown with an arrow.



- Clicking [Restore default] restores all settings on the printer driver screen to their default values.
- When optional equipment is connected, first configure the settings in [Printer Configuration] under the [Environment] tab to use certain functions. The unavailable functions are grayed out. (p. 3-26 "[Environment] Tab")

List of Settings

List of Printer Driver Settings

The following is a list of the settings that can be configured via the printer driver.

Setting item	Description	See
[Basic] Tab		
Color Mode	Select color or monochrome printing.	p. 3-9
Duplex / Simplex	Specify simplex or duplex printing.	p. 3-9
Copies	Enter the number of copies to print.	p. 3-10
Print and Pause	To check the printing result, the machine stops after printing one set.	p. 3-10
Sort	Specify the paper output method when printing multiple copies.	p. 3-10
Original Size	Specify the paper size and orientation of the original.	p. 3-10
Mixed Size Original	Use this option when multiple different original sizes are used in the original data.	p. 3-11
Zoom	Specify enlargement or reduction of original images before printing, if needed.	p. 3-11
Paper Size	Specify the size of paper for printing.	p. 3-11
Paper Tray	Specify the tray where paper for printing is loaded.	p. 3-12
Paper Type	Specify the type of printing paper.	p. 3-12
Output and Destination	Select the output for the document data sent from a computer. If [Storage] or [Save as a File] is selected for [Output], this field shows the destination.	p. 3-12
Add to Favorites	Register the current settings in the Favorites tab.	p. 3-13
[Favorites] Tab		
List	Check the settings registered as favorites.	p. 3-14
Edit Favorites	Edit the registered favorites.	p. 3-14
Open File	Open a saved favorites file.	p. 3-14
Save in File	Save a favorite as a dedicated file format with the extension ".uds".	p. 3-14
Add to Favorites	Register the current settings in the Favorites tab.	p. 3-14
[Layout] Tab		
Combine	Use this option to combine multiple continuous pages.	p. 3-15
Image Repeat	Use this option to print the same page multiple times on one sheet.	p. 3-15
Booklet	Specify the imposition for middle-binding booklets.	p. 3-16
Watermark	Specify the background watermark to be added to document pages.	p. 3-16
Stamp	Use this option to stamp the page number and date in the header or footer.	p. 3-17
Image Position	Specify this when adjusting the print position.	p. 3-18
Rotation	Specify the print orientation.	p. 3-18
Add to Favorites	Register the current settings in the Favorites tab.	p. 3-19

Setting item	Description	See
[Finishing] Tab		
Binding Edge	Specify the binding margin.	p. 3-19
Staple	Select the stapling position. (When using the optional face down finisher)	p. 8-4
Offset Output	Specify the timing to offset output. (When using the optional face down finisher)	p. 8-3
Slip Sheet	Specify the timing for inserting the slip sheet between printouts.	p. 3-20
Add Cover	Use this option when adding front and back covers to the front and back of the printout.	p. 3-20
Output Tray	Specify the output tray. (When using the optional stacking tray)	p. 8-11
Output Tray Relay	Select this to switch the output tray automatically when the tray is full. (When using the optional auto-control stacking tray)	p. 8-11
Add to Favorites	Register the current settings in the Favorites tab.	p. 3-20
[Image] Tab		
Original Type	Specify whether to emphasize the image quality of photos or text for the printout.	p. 3-21
Print Density	Specify the print density.	p. 3-21
Image Quality	Specify the print resolution.	p. 3-21
Line Smoothing	Select this to smooth the outline of text or illustrations.	p. 3-21
Screening	Specify the halftone processing method.	p. 3-22
Gamma Correction	Correct the lightness, chroma, contrast, and RGB gamma value.	p. 3-22
Barcode Area Definition	Use this option when printing a barcode.	p. 3-22
Envelope Imaging	Specify the image processing for envelope printing.	p. 3-24
Add to Favorites	Register the current settings in the Favorites tab.	p. 3-24
[Advanced] Tab		
Owner	Use this option to set up an owner name of your choice.	p. 3-24
Job Name	Select this when setting a desired job name.	p. 3-24
PIN Code	Use this option to add a PIN code to data.	p. 3-24
Job Comment	Use this option to add a comment to a job.	p. 3-25
Program	Use this option when distributing different numbers of copies to multiple groups.	p. 3-25
Slow Printing	This option slows down the printing speed as well as reduces the operating sound of the job being processed.	p. 3-25
Blank Page Detection	Use this option to not print any blank pages included in the document.	p. 3-25
Version	You can view the printer driver version.	p. 3-26
Add to Favorites	Register the current settings in the Favorites tab.	p. 3-26

List of Print Mode Function Buttons

The function buttons available in Print mode are listed below.

Setting item	Description	See
Online / Offline	This function switches the network connection status (online/offline) of this machine.	p. 3-29
External System Job	It appears when [External System Link] is set up by the administrator. You can print or delete jobs, or check amounts.	p. 3-29
Details	Use this option to check the current settings.	p. 3-30
Change Setting	Use this option to change job settings.	p. 3-30

Printer Driver Settings

This section describes how to configure the basic settings of the printer driver, such as for color mode, duplex/simplex printing, and paper type.

[Basic] Tab

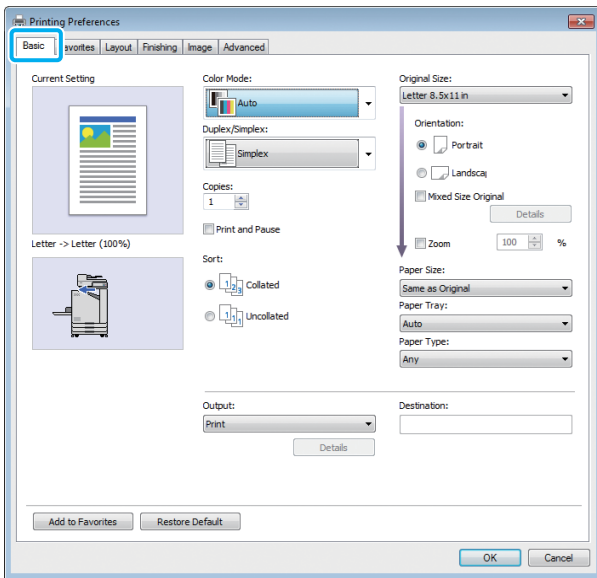

Color Mode

Select a color mode.

[Auto]

The machine automatically reads the color of the document and prints in full color (cyan, magenta, yellow, and black) or black accordingly.

[Full Color]

Select this option to print in four colors (cyan, magenta, yellow, and black).

[Black]

Select this option to print in one color (black) regardless of the colors used in the document.

[Cyan]

Select this option to print in one color (cyan) regardless of the colors used in the document.

[Magenta]

Select this option to print in one color (magenta) regardless of the colors used in the document.

Duplex / Simplex

Specify simplex or duplex printing.

[Simplex]

Data is printed on one side of the paper.

[Duplex (Long Edge)]

Data is printed on both sides of the paper with the long edge as the binding position.

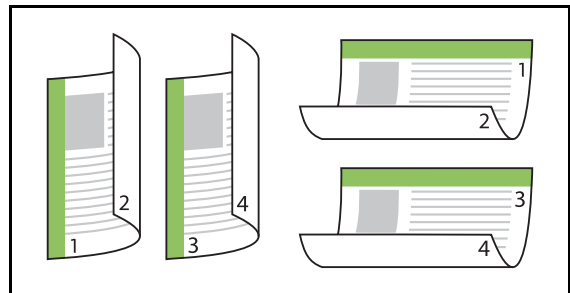

[Duplex (Short Edge)]

Data is printed on both sides of the paper with the short edge as the binding position.

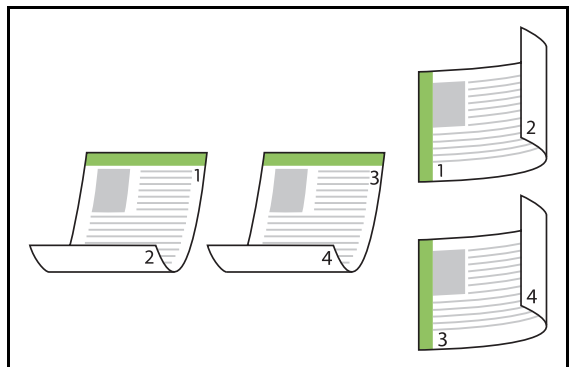

- To print on both sides of the paper with mixed-size documents, specify the binding orientation in the [Mixed Size Original] dialog box on the [Mixed Size Original] screen.

Copies

Enter the number of copies (1 to 9999) to print.



- When program has been configured, you cannot enter the number of copies.

Print and Pause

When printing a document with a large number of pages or sheets, a page or a set is printed (this page or set is not included in the number of pages specified) for you to check before starting the actual printing. After you check the printout, press the [Start] key on the printer to continue printing. Select the check box to enable this option.



- According to the print unit ([Uncollated] or [Collated]) selected under [Sort], a printout for your check is output.
- After checking the printout, you can change the settings on the operation panel of the printer. (p. 3-3 "Changing Settings During Printing")

Sort

Specify the paper output method when printing multiple copies.

[Collated], [Uncollated]



- You cannot use the [Uncollated] option with the [Booklet] function. (p. 3-16 "Booklet")
- If [Collated] is selected, remove the check mark from [Collate] in the Print dialog box of the application. Documents may not be properly printed if this check box is selected.

Original Size

Specify the paper size and orientation of the document data.

[Orientation]

[Portrait], [Landscape]



- When printing on envelopes, it is recommended that you connect the optional stacking tray and envelope feeder.
- The list shows the sizes registered in [Custom Paper Entry] in the [Environment] tab. (p. 3-27 "Custom Paper Entry")

■ Specifying a Custom Size

When the document is a non-standard size, select [Custom].

1 Select [Custom] for [Original Size].

The [Custom] dialog box is displayed.

2 Enter the document size.

3 Click [OK].



- The size entered here is only valid when configuring the document size. Registering frequently-used document sizes can be useful. (p. 3-27 "Custom Paper Entry")

Mixed Size Original

Use this option when multiple different original sizes are used in the original data. Select this check box to enable automatic selection of the paper tray that suits the document size.



- You cannot use the [Mixed Size Original] option with the [Combine], [Image Repeat], or [Booklet] function. (p. 3-15 "Combine", p. 3-15 "Image Repeat", p. 3-16 "Booklet")
- When using this function with duplex printing, duplex printing is only applied when the size of the front and back of the document is the same. (If the size is not the same, the back of the page is left blank.)
- When printing the mixed-size document data without selecting the [Mixed Size Original] check box, all pages are printed in the size of the first page.

■ Using This Function with Duplex Printing

When using this function with duplex printing, you can set the binding position for each paper size.

Select the [Mixed Size Original] check box and click [Details] to display the [Mixed Size Original] dialog box. Select the binding position for each size.

[Larger Page]

[Long Edge], [Short Edge]

[Smaller Page]

[Long Edge], [Short Edge]

[Rotate Larger Page 180 Degrees]

Select the [Rotate Larger Page 180 Degrees] check box to rotate the larger pages 180 degrees.



- [Larger Page] means A3, B4 (Ledger, Legal), and Tabloid; [Smaller Page] means other sizes.
- Some applications do not allow you to rotate the larger pages to the desired orientation. In this case, select the check box to rotate the print orientation 180 degrees.

Zoom

Specify the enlarge/reduce ratio of the original.

Select the [Zoom] check box and enter the enlarge/reduce ratio in the range of 50% to 200%.

If you do not select [Zoom], the enlarge/reduce ratio is automatically selected based on the [Original Size] and [Paper Size] settings.

Paper Size

Specify the size of paper for printing.



- When printing on envelopes, it is recommended that you connect the optional stacking tray and envelope feeder.
- The list shows the sizes registered in [Custom Paper Entry] in the [Environment] tab. (p. 3-27 "Custom Paper Entry")

■ Specifying a Custom Paper Size

When the paper is a non-standard size, select [Custom].

1 Select [Custom] for [Paper Size].

The [Custom] dialog box is displayed.

2 Enter the size of the paper.

3 Click [OK].



- The size entered here is only valid when configuring the document size. Registering frequently-used paper sizes can be useful. (p. 3-27 "Custom Paper Entry")

Paper Tray

Specify the input tray to use for printing.

[Auto]

The paper tray is selected automatically according to the [Paper Type] and [Paper Size] settings.

[Feed Tray 1], [Feed Tray 2]

The paper loaded in the specified tray is used for printing.

[Standard Tray]

The paper loaded in the standard tray is used for printing.



- If [Auto] is selected, but the actual paper loaded in the tray does not match the [Paper Size] and [Paper Type] settings (or the same paper is loaded but the tray selection setting is not set to [Auto Selection]), an error occurs and the job is not printed. Select [Any] in [Paper Type]. (p. 3-12 "Paper Type")
- You can use the RISO Console to confirm the paper size and paper type loaded in the printer paper tray. See "[Consumables] Screen" (p. 6-6) in "RISO Console".

Paper Type

Select the type of printing paper.

You can print the document data with adjustments, such as coloration and amount of ink, and image processing that suit the selected paper type.

[Any]

Select this option to enable automatic selection of paper type according to printer settings.

[Plain]

[IJ Paper], [Matt Coated]

Select one of these when using IJ paper or similar paper.

[High-quality]

[Card-IJ]



- The machine selects the color profile that is most suitable for your paper type. To print with the appropriate color balance, match the printer paper settings with the loaded paper.
- If [Any] is selected, communication may not be established with the printer. If the printer's paper settings are changed after sending a print job, the paper type and image processing may not be compatible.

Color profile

Colors on a monitor or other display are expressed in terms of the three primary colors of light (RGB: red, green, and blue), however colors printed with ink are expressed in terms of the three primary colors (CMY: cyan, magenta, and yellow).

Because CMY, which is used to express the colors printed on paper, has fewer colors than RGB, which is used to express colors displayed on a computer monitor, the printer cannot print the colors exactly as seen on the monitor. For this reason, it is necessary to use a special method to convert RGB colors to CMY colors so as to reproduce nearly the same colors or natural colors.

This method is called "color management", and the conversion table is called a "color profile".

With color management, the printer automatically selects several types of color profiles to obtain the optimal color according to the combination of the original image and paper being used.

- This printer uses color profiles created and edited based on the ColorSet technology licensed from Monotype Imaging K.K.

Output and Destination

Specify whether to print the data sent from a computer or save it to a folder on the printer.

You can also save the data to a USB flash drive as a PRN file, or create a file to use in the Barcode Area Definition Software.

[Print]

Document is printed.

[Print & Storage]

The document is printed and the data is saved in a folder on the printer.

[Storage]

You can save the document data to a folder on the printer as a PRN file.

[Save to USB Drive]

You can save the document data to a USB flash drive as a PRN file. Even if you do not have a network environment, you can print by connecting a USB flash drive to the machine.

[Save as a File]

A PRN file is created to be used in the Barcode Area Definition Software.



- Do not remove the USB flash drive until saving is finished. During data saving, a printer icon appears in the taskbar shown on the computer. When saving is completed, the printer icon disappears. Make sure that the icon has disappeared before removing the USB flash drive.



- The data saved in a folder on this machine can be printed from the [Storage] - [Load] screen (p. 4-3), or from "[Storage] Menu" (p. 6-11) on "RISO Console".
- The data saved on a USB flash drive can be printed from the [USB] - [Load] screen by connecting the USB flash drive to the machine. You can also save the data to this machine by copying it to a folder on the machine. (p. 5-7 "Copy to Folder")
- A PRN file is a dedicated file format in which data is output via the printer driver. This type of file can only be opened on a RISO printer or application.
- The computer user name is added, as the owner, to the data saved to a folder on the machine.

■ Destination Folder Settings

The folders registered in [Folder Entry] on the [Environment] tab are displayed in [Destination]. (p. 3-26 "[Environment] Tab")

1 In [Output], select [Print & Storage], [Storage] or [Save to USB Drive].

2 Click [Details].

The [Output] dialog box is displayed.

3 In the [Destination] pull-down menu, select the directory of the original data.

- The available folders are displayed in the [Destination] list.

4 Click [OK].

The selected folder name is displayed in the [Destination] field.

Add to Favorites

The current settings on the printer driver screen can be saved to retrieve later as needed. Up to 30 groups of settings can be saved.

1 Configure the necessary settings on the printer driver screen.

2 Click [Add to Favorites].

The [Add to Favorites] dialog box is displayed.

3 Enter a name.

- Enter a name up to 20 characters long.

4 Click [Entry].

The settings are saved and displayed in the [Favorites] tab.

[Favorites] Tab

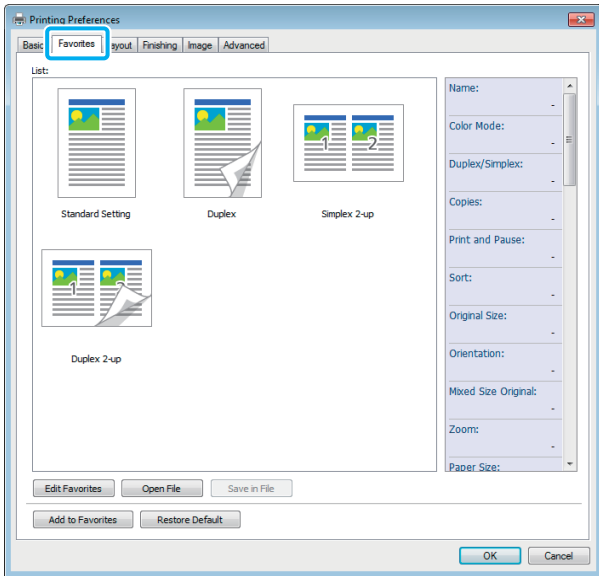

List

The printer driver settings registered as favorites are displayed in a list. The recommended settings are pre-registered as favorites. Click a favorite to display the details of the selected favorite settings in a list. The print settings are changed according to the selected favorite settings.

Edit Favorites

Edit the registered favorites.

[Current Setting]

The selected favorite settings are displayed.

[List]

The registered favorites are displayed.

[Up], [Down]

You can change the display order for the favorites in [List] using these keys.

[Rename]

You can change the registered name of a favorite. Enter a new name with 1 to 20 characters.

[Delete]

You can delete a favorite.

Open File

You can call and use printer driver settings saved in a computer.

1 Click [Open File].

The [Open] dialog box is displayed.

2 Select a file on the computer.

3 Click [Open].

The loaded settings are displayed in [List].

Save in File

You can save the settings that are registered as a favorite to a computer. It is useful to save settings to a computer when, for example, you want to share the settings among multiple users or reinstall the printer driver.

1 Select the settings in [List] that you want to save to a computer.

2 Click [Save in File].

The [Save As] dialog box is displayed.

3 Specify the destination folder and file name.

4 Click [Save].

The selected settings are saved.

Add to Favorites

The current settings on the printer driver screen can be saved to retrieve later as needed. Up to 30 groups of settings can be saved. For more information, see "Add to Favorites" (p. 3-13).

[Layout] Tab

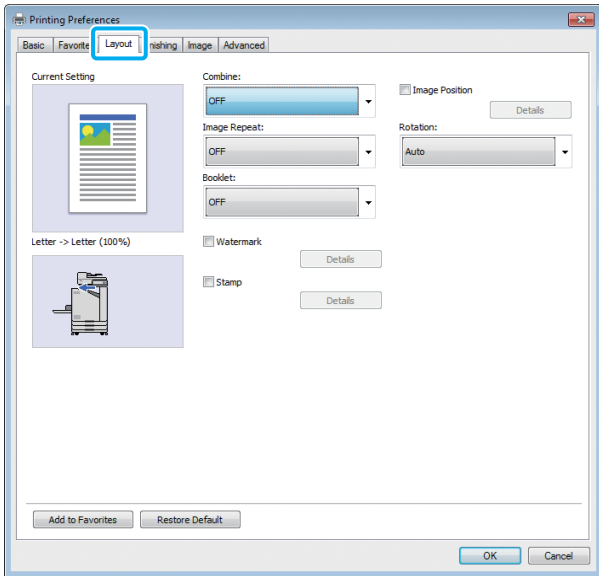

Combine

This function imposes continuous pages onto one sheet for printing.

- You cannot use the [Combine] function with [Mixed Size Original], [Image Repeat], or [Booklet] function. (p. 3-11 "Mixed Size Original", p. 3-15 "Image Repeat", p. 3-16 "Booklet")

[OFF], [2 Pages: Left to Right], [2 Pages: Right to Left], [2 Pages: Top to Bottom], [2 Pages: Bottom to Top], [4 Pages: Left Top to Bottom], [4 Pages: Left Top to Right], [4 Pages: Right Top to Bottom], [4 Pages: Right Top to Left], [8 Pages: Left Top to Bottom], [8 Pages: Left Top to Right], [8 Pages: Right Top to Bottom], [8 Pages: Right Top to Left]

Select the number of pages per sheet and the order that they are laid out.

Example: If [4 Pages: Left Top to Bottom] is selected

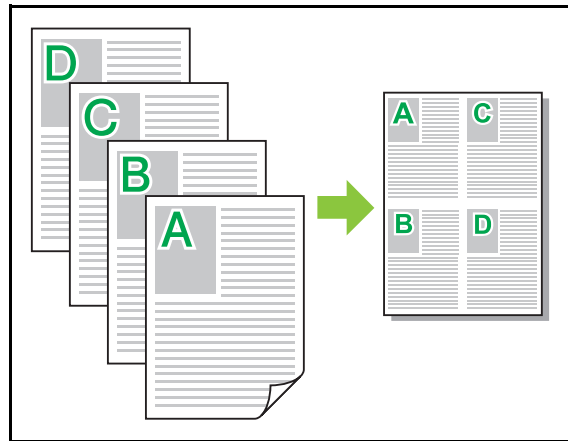

Image Repeat

3

The same page is printed multiple times on one sheet.

- You cannot use the [Image Repeat] function with [Mixed Size Original], [Combine], or [Booklet] function. (p. 3-11 "Mixed Size Original", p. 3-15 "Combine", p. 3-16 "Booklet")

[OFF], [2 pages], [4 pages], [8 pages]

Select the number of pages per sheet.

Example: If [4 Pages] is selected

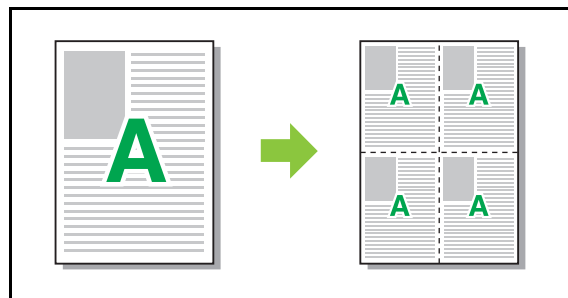

Booklet

Continuous multiple pages are imposed and printed to create a middle-binding booklet after duplex printing.



- You cannot use the [Booklet] function with [Mixed Size Original], [Combine], or [Image Repeat]. (p. 3-11 "Mixed Size Original", p. 3-15 "Combine", p. 3-15 "Image Repeat")

[OFF], [Left to Right], [Right to Left], [Top/Bottom]
Specify the layout order. The [Left to Right] and [Right to Left] options appear when [Portrait] is selected for [Original Size]. The [Top/Bottom] option appears when [Landscape] is selected for [Original Size].

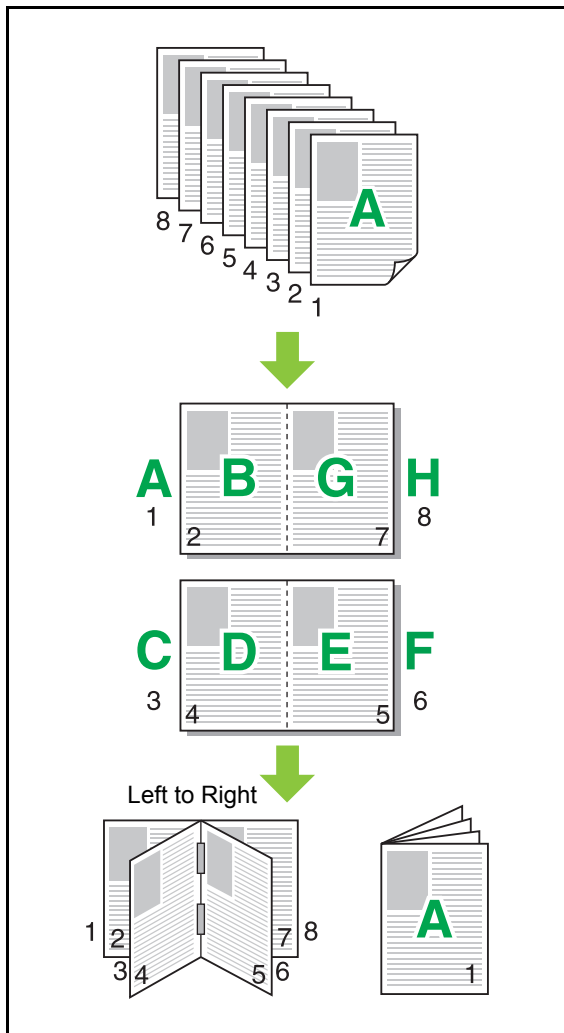

Watermark

Add a watermark of the desired size and in the desired position on printouts.

Select the [Watermark] check box and click [Details] to display the [Watermark] dialog box. Select a character string from the character string list and configure the necessary settings.

The selected settings are immediately applied to the preview image.

Text

[Select Text]

[Confidential], [Important], [Circulation], [Reference], [Urgent], [Copying Prohibited]

[Add]

You can also add a character string of up to 63 characters long.

Click [Add] under the character string list, and enter the character string in the [Add] dialog box.

[Delete]

Select the character string to delete from the list, and click [Delete].

You cannot delete the default character strings (Confidential, Important, Circulation, etc.).

[Input Text]

[Apply]

You can also print a character string of up to 63 characters long, but you cannot register it; enter a character string each time. Click [Apply] to apply the entered character string to the preview image.



- You need to have administrative authority for your computer to add or delete a watermark character string.

Preview

The image according to the settings is displayed. You can also use the mouse pointer to adjust the position in the preview image.

Apply Page

[All Pages], [First Page]

■ Text decoration

[Font]

Select a font and style.

[Size]

Specify the character string size.

[Color]

Specify the color of the character string. Click [Others] to select a color from the color palette of the operating system.

[Transparency]

Specify the transparency of the character string. A higher transparency means that the print data will be more visible in the background of the watermark character string.

[Frame]

[No], [Circle], [Rectangle], [Double Rectangle]

Select a frame for the watermark.

■ Print Position

[Text Angle]

[0 deg], [90 deg], [270 deg], [Oblique (45 deg)],
[Oblique (315 deg)], [Custom] (0-360 deg)

Select the angle of the text. You can also enter the numerical angle of the text.

[Print Position]

[Center], [Top Left], [Top Center], [Top Right],
[Center Right], [Bottom Right], [Bottom Center],
[Bottom Left], [Center Left], [Custom]

Select the print position of the watermark. You can also enter the values for the positions in the vertical and horizontal directions.

Stamp

Use this option to stamp the page number and date in the header or footer.

Select the [Stamp] check box and click [Details] to display the [Stamp] dialog box. Use the tab screens to configure the settings.



- The page number and date cannot be stamped together in the same position.
- When using this function with [Combine] or [Image Repeat], the page number and date are stamped on each page of the copy paper, not per page of the original document. When using this function with [Booklet], the page number and date are stamped on each booklet page.

■ Page

To stamp the page number, select [ON] on the [Page] tab screen.

[Top Left], [Top Center], [Top Right], [Bottom Left],
[Bottom Center], [Bottom Right]

Specify the print position.

[Transparency]

Select the [Transparency] check box to have the page number stamped on top when the stamp area and images overlap.

Remove the check mark to create a white space by removing images in the stamp area, and then stamp the page number in that white space.

[Start Number]

Enter the stamp start number.

[Stamp Start Page]

Enter the stamp start page. To not stamp on the cover, set [Stamp Start Page] to "2" (For duplex printing, set this to "3" depending on the case).

[Font]

Select a font and style.

[Size]

Specify the page number text size.

■ Date

To stamp the date, select [ON] on the [Date] tab screen.

[Top Left], [Top Center], [Top Right], [Bottom Left], [Bottom Center], [Bottom Right]

Specify the print position.

[Transparency]

Select the [Transparency] check box to have the date stamped on top when the stamp area and images overlap.

Remove the check mark to create a white space by removing images in the stamp area, and then stamp the date in that white space.

[Apply Page]

When this option is set to [All Pages], the date is stamped on all pages.

When this option is set to [First Page], the date is stamped only on the first page.

[Stamp Date]

Select [Today] to stamp the date based on the date information of the computer.

Select [Specify Date] to enter a date of your choice in the text box.

[Font]

Select a font and style.

[Size]

Specify the date text size.

Image Position

Adjust the printing position of images.



- You can move the image position up to 20 mm (13/16") in all directions (up, down, left, right).
- When performing duplex printing, the front and back sides can be adjusted separately.

Select the [Image Position] check box and click [Details] to display the [Image Position] dialog box.

Enter a value in the data entry field of the direction that you want to adjust.

[Front Side], [Back Side]

Enter values in [Horizontal] and [Vertical].

[Reset]

All values are reset to zero.

Rotation

Specify the print orientation.

[Auto], [0 deg], [90 deg], [180 deg], [270 deg]

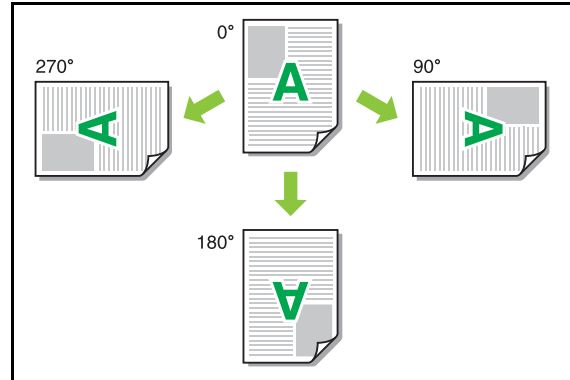

When [Auto] is selected, the print orientation is set automatically according to the orientation of the document data and the orientation of the paper loaded in the paper tray. For normal use, select [Auto].



- To align the print orientation with an envelope or other paper with a fixed feeding direction, specify the angle of rotation.
- [Auto] may be the only option available depending on the document size, the size and orientation of the paper loaded in the tray, and other settings.

Add to Favorites

The current settings on the printer driver screen can be saved to retrieve later as needed. Up to 30 groups of settings can be saved. For more information, see "Add to Favorites" (p. 3-13).

[Finishing] Tab

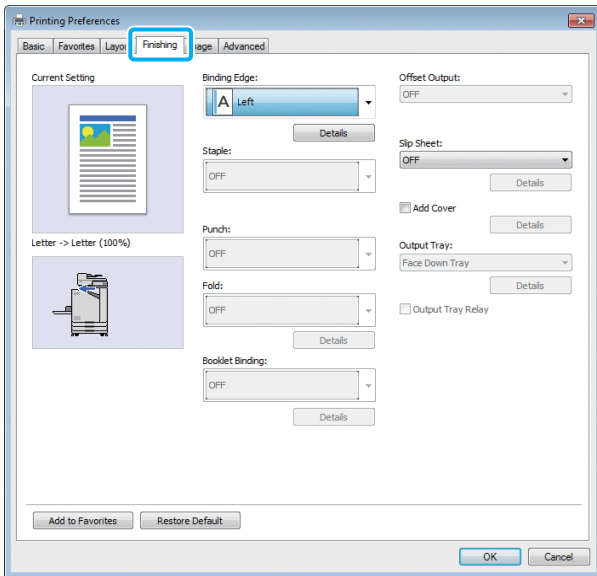

Binding Edge

Specify the binding margin.

[Left], [Right], [Top]

■ Binding Margin Settings

Select the binding edge and click [Details] to display the [Binding Edge] dialog box.

Specify the margin width.

Select the [Auto Reduction] check box to automatically reduce the printed image to fit the paper in cases where the margin width does not allow for the original-scale printed image to fit into the paper.

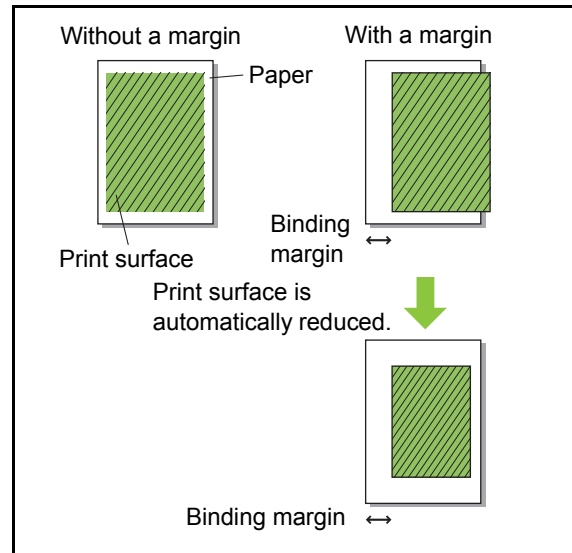

3

Staple

If you are using the optional face down finisher, the staple function is available.

For more information, see "Staple" (p. 8-4) in "Optional Equipment".

Offset Output

If you are using the optional face down finisher, you can offset the output position.

For more information, see "Printer Driver Settings" (p. 8-3) in "Optional Equipment".

Slip Sheet

Use this function to insert a slip sheet between print units when printing multiple copies. You can stamp a number or letter on slip sheets.

[OFF]

Slip sheets are not inserted.

[Between Sorts]

A slip sheet is inserted between sets, based on the unit specified in [Sort].

[Between Jobs]

A slip sheet is inserted between print jobs.

Select whether to insert a slip sheet between sorts or between jobs, and click [Details] to display the [Slip Sheet] dialog box.

Select the tray for slip sheets and specify the text to stamp.

Slip Sheet Tray Selection

[Standard Tray], [Feed Tray 1], [Feed Tray 2]

Number on Slip Sheet

The text is printed at the bottom (within approx. 5 mm (7/32") of the edge) or top (within approx. 5 mm (7/32") of the edge) of the sheet.

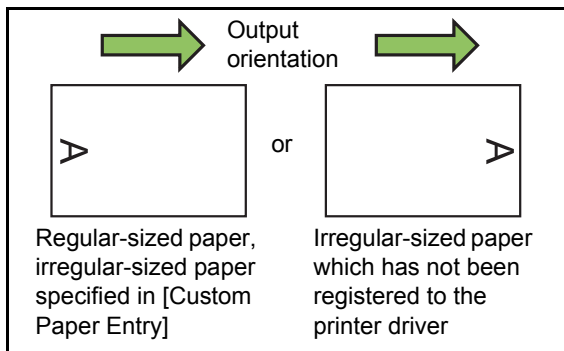

[OFF]

Nothing is stamped.

[1 2 3 ...]

Numbers are stamped on slip sheets in numerical order (1, 2, 3...). (Up to 9999)

[A B C ...]

Letters are stamped on slip sheets in alphabetical order (A, B, C...Z, AA, AB, AC...). (Up to ZZZ)

Add Cover

Specify this option to add a front and/or back cover. Paper is added from a specified tray before or after the data to be printed. Specify this option to use colored paper or paper that differs from the pages to be printed.

Select the [Add Cover] check box and click [Details] to display the [Add Cover] dialog box. Select [Add Front Cover] or [Add Back Cover], or both check boxes, and specify the tray for the selected cover.

[Add Front Cover]

This option inserts a cover sheet before the first page.

[Add Back Cover]

This option inserts a cover sheet after the last page.

[Select Front Cover Tray], [Select Back Cover Tray]
[Standard Tray], [Feed Tray 1], [Feed Tray 2]



- Specify the trays loaded with paper to be used for the covers.

- When loading preprinted paper, it is recommended that one set be printed to check that the orientation matches that of the other pages to be printed.

Output Tray

If you are using the optional stacking tray, you can select the trays for output.

For more information, see "Output Tray" (p. 8-11) in "Optional Equipment".

Output Tray Relay

If you are using the optional auto-control stacking tray, the output tray relay function is available.

For more information, see "Output Tray Relay" (p. 8-11) in "Optional Equipment".

Add to Favorites

The current settings on the printer driver screen can be saved to retrieve later as needed. Up to 30 groups of settings can be saved.

For more information, see "Add to Favorites" (p. 3-13).

[Image] Tab

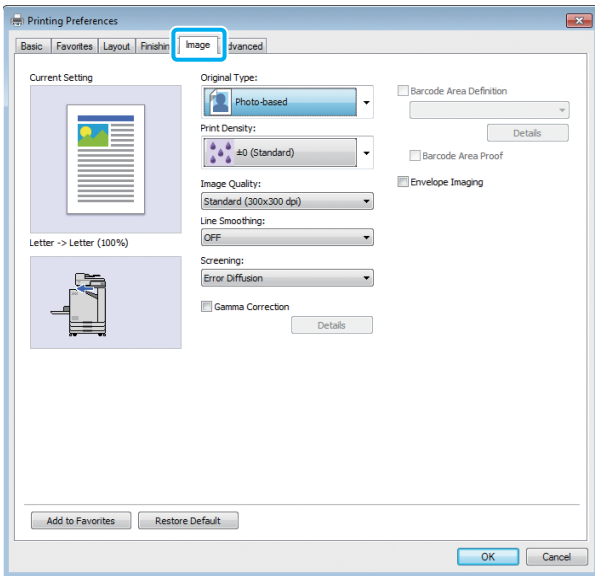

Original Type

Select whether to give priority to the image quality of photos or text in originals.

[Photo-based]

This option processes image data with more natural colors.

[Line-based]

This option processes text and illustrations with sharp rendering.

Print Density

Specify the print density.

[-3] (light), [-2], [-1], [0 (Standard)], [+1], [+2], [+3] (dark)

Image Quality

Specify the image resolution.

[Standard (300 × 300 dpi)]

Suitable for documents and other originals with text.

[Draft (300 × 300 dpi)]

Ink consumption is reduced when printing. When less ink is used, print density is reduced and the neutral colors become uneven.

[Data Compression (300 × 300 dpi)]

Use this option to prioritize network communication speed over quality. When file size of the print data becomes smaller, neutral colors become uneven.

[Fine (300 × 600 dpi)]

This option is suitable for photos and similar originals.



- Printing will take longer if you select [Fine (300 × 600 dpi)].

Line Smoothing

This function supplements the intermediate colors of drawing and background colors in outline sections of text or illustrations (line drawing) to make the outlines smoother.

You can select either of two different image processing types.

[OFF]

Select this option if you do not want to perform line smoothing.

[Low]

Select this option to make outlines smoother.

This is appropriate for printing the data that do not need fine processing.

[High]

Select this option to make outlines smoother and make fine characters and lines clearer.

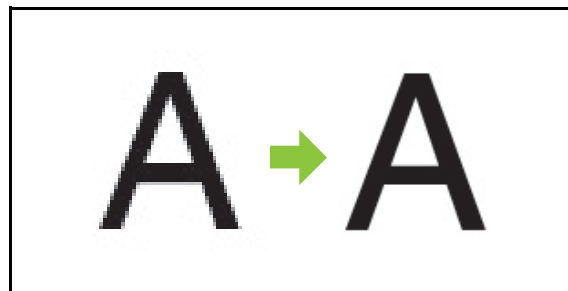

(Image)



- The line smoothing function's image processing is inversely proportional to processing speed (print speed). The higher the image quality, the lower the print speed.

Screening

Specify the halftone processing method.

Halftone is a processing method that varies the density and size of ink dots printed on paper to give the appearance of continuous color gradation when only using a limited number of inks.

[Error Diffusion]

Gradation is expressed through the density of dots. The higher the density, the darker the gradation. The lower the density, the lighter the gradation.



[Dot Process (70 lpi)], [Dot Process (100 lpi)]

Gradation is expressed by changing the size of the dots. The larger the dots, the darker the gradation. The smaller the dots, the lighter the gradation. A dot process of 100 lines per inch provides more detailed images.

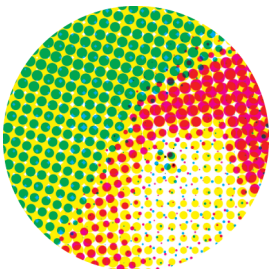

70 lines per inch

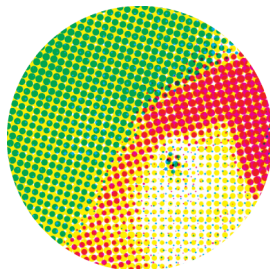

100 lines per inch

(Enlarged image)

Gamma Correction

Use this function to correct the lightness, chroma, contrast, and RGB gamma value.

Select the [Gamma Correction] check box and click [Details] to display the [Gamma Correction] dialog box. Enter a value between -25 and +25 for each item.

[Lightness]

The smaller the value, the darker (blackish) the color. The larger the value, the brighter (whitish) the color.

[Chroma]

The smaller the value, the more washed-out the color. The larger the value, the more vivid the color.

[Contrast]

Adjust the brightness contrast.

The smaller the value, the lower the contrast. The larger the value, the higher the contrast.

[Red], [Green], [Blue]

Adjust the gamma value of each color.

The smaller the value, the weaker the color. The larger the value, the stronger the color.



- When printouts are yellowish, lower the values of red and green. To adjust other colors, consult with the administrator for configuration.

Barcode Area Definition

This function makes the print density of the specified barcode area suitable for reading.

[Barcode Area Definition]

Select the check box, and select an area definition file to print from the pull-down menu.

[Details]

Click [Details] to display the [Barcode Area Definition] dialog box. The print density of the specified barcode area can be set to a value between -3 and +3.

[Barcode Area Proof]

You can check on printouts (printouts with shades on a barcode print area) whether the barcode area definition is out of alignment, and whether letters or illustrations lie over the 1 mm (0.04") around the barcode.

■ Creating a Barcode Area Definition File

To use the [Barcode Area Definition] function, use the Barcode Area Definition Software beforehand to create a CSV file that specifies the barcode print area for registering in the printer.

For how to install the Barcode Area Definition Software, how to specify the barcode area, and how to register the definition file in the printer, see "Using the Barcode Area Definition Software" (p. 7-1).

■ Checking the Barcode Area Definition

Select the [Barcode Area Proof] check box and click [OK] to output a printout for checking. Check whether the specified area is out of alignment. If the specified area is not printed in the desired position, use the Barcode Area Definition Software again to re-configure the barcode area.

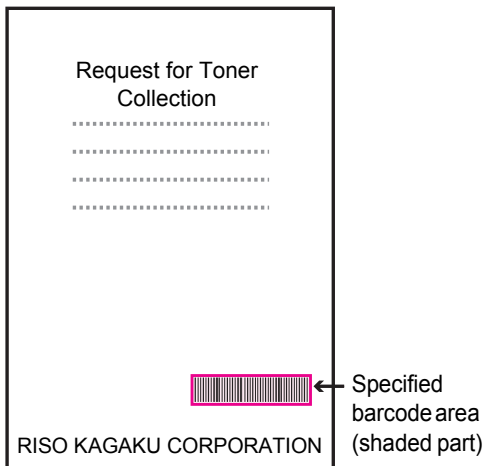

Correct Specification

- Surround the barcode with a margin of 1 mm (0.04") or more.



- The specified area cannot be smaller than the barcode.



- The specified area must be aligned with the barcode.



- Do not include another object with the barcode. Any non-black image inside the specified area is printed out white (disappears).



- In the area specified as the barcode area, regardless of the color of the original, the base color is white, and the barcode color is black. When the document is printed using [Barcode Area Proof], the specified barcode area is printed in the color specified in the [Color Mode] setting.
- The type of targeted barcodes is one-dimensional. If the barcodes are two-dimensional (e.g., QR code), you do not need to perform this setting.
- If you print using different resolutions for the application that created the original and the printer, barcodes may not be able to be read correctly even using this function.

■ Printing Barcode Originals

Once the barcode area is correctly defined, print the document.

- 1 Open the printer driver from the Print menu on the document application screen.**
- 2 On the [Image] tab screen, select the [Barcode Area Definition] check box.**
- 3 Select the barcode area definition file from the pull-down menu.**
- 4 Click [OK].**
The print density of the barcode area is appropriately configured before printing.



- Set the settings of frequently used barcode originals as the default settings. This will enable you to print barcodes without performing necessary settings each time, making barcode printing easy.

■ How to Register to the Default

- 1 Right-click the FW series printer from [Devices and Printers] on the [Start] menu.
- 2 Open the printer driver screen from [Print Setting] to display the [Image] tab screen.
- 3 Configure the settings necessary for barcode printing, and click [Apply].

The "barcode area definition" file is registered as the default settings. From now on, you can perform barcode printing just by selecting the printer driver.

Envelope Imaging

Prevent blur and small stains during envelope printing. Select the [Envelope Imaging] check box.

Add to Favorites

The current settings on the printer driver screen can be saved to retrieve later as needed. Up to 30 groups of settings can be saved. For more information, see "Add to Favorites" (p. 3-13).

[Advanced] Tab

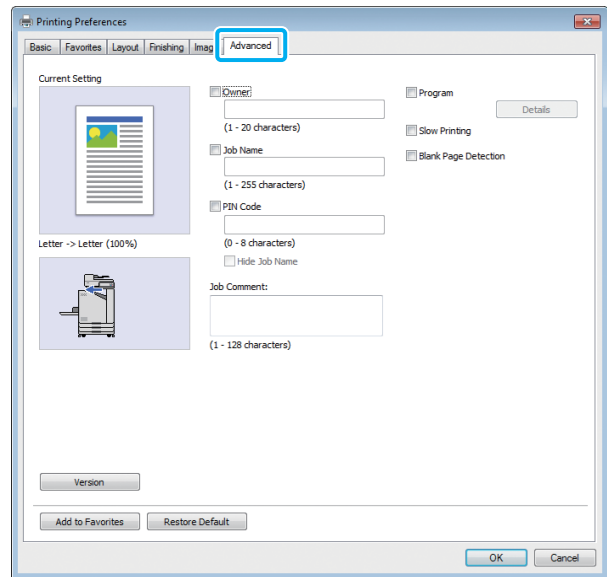

Owner

You can enter an owner's name of your choice. Select the [Owner] check box to enter the owner's name.

Job Name

You can enter a job name of your choice. Select the [Job Name] check box to enter the job name.

PIN Code

You can set a PIN code when printing a document you do not want others to view. To print a PIN code-protected job, enter the PIN code using the operation panel of the printer. Select the [PIN Code] check box and enter a PIN code. When [Hide Job Name] is selected, the job name is displayed with asterisks (*) on the operation panel of the printer and on the RISO Console.



- Manage the PIN code so as not to forget it. Users without administrative authority cannot delete jobs from a list for which the PIN code is unknown. Contact the administrator to delete these jobs.

Job Comment

You can enter a comment for printer users. You can display job comments using the operation panel of the printer or the RISO Console.

Program

This function is useful when distributing different numbers of copies to multiple groups. You can configure up to 60 groups.

Select the [Program] check box and click [Details] to display the [Program] dialog box. Specify the number of copies and sets for each group.

Entering the Number of Copies and Sets

You can specify up to 9,999 copies and 99 sets per group.

For example, to distribute a document to four divisions in an office, you can use [Program] to print by the number of sheets per division with a single operation.

Division	General Affairs 1	General Affairs 2	Accounting	Management
No. of employees	10	6	24	6

To print the leaflets by group, configure the settings as follows.

Division	General Affairs 1	General Affairs 2	Accounting	Management
No. of copies × No. of sets	10 × 1	6 × 1	24 × 1	6 × 1

Even if two divisions have the same number of employees (such as General Affairs 2 and Management), you can configure the settings as follows to print by the number of sheets per division.

Group	01G (General Affairs 1)	02G (General Affairs 2 and Management)	03G (Accounting)
No. of copies × No. of sets	10 × 1	6 × 2	24 × 1

Sort

Specify whether to print page by page or in sets. [Uncollated], [Collated]

Slip Sheet (Program)

Insert a slip sheet to separate printouts into specified units.

[OFF]

Slip sheets are not inserted.

[Between Sets]

Slip sheets are inserted between sets.

[Between Groups]

Slip sheets are inserted between groups.

Slip Sheet Tray

[Feed Tray 1], [Feed Tray 2], [Standard Tray]

Number on Slip Sheet

When this check box is selected, numbers are stamped on the slip sheets.

If [Between Sets] is selected, the group number and set number are stamped.

If [Between Groups] is selected, the group number is stamped.

Offset Output (Program)

This function is available when the optional face down finisher is connected. (p. 8-6 "Offset Output (Program)")

Slow Printing

This option slows down the printing speed. This also reduces the operating sound of the job being processed.

Blank Page Detection

The print data is printed excluding the blank pages.



- "Blank pages" means pages that are normally output without anything printed on them. Pages are printed even if they have only a header or footer but no main text.

Version

Check the "version" and "color profile" of the printer driver, as well as the "model name" of the printer.

Add to Favorites

The current settings on the printer driver screen can be saved to retrieve later as needed. Up to 30 groups of settings can be saved. For more information, see "Add to Favorites" (p. 3-13).

Environment Settings

This section describes how to configure the environment settings, including the configuration of optional equipment connected to the machine. When using the printer driver for the first time or adding optional equipment to the machine, configure the printer configuration.

[Environment] Tab

To display the [Environment] tab, go to [Devices and Printers] from the [Start] menu, right-click the FW series printer, and open the [Printer Properties].

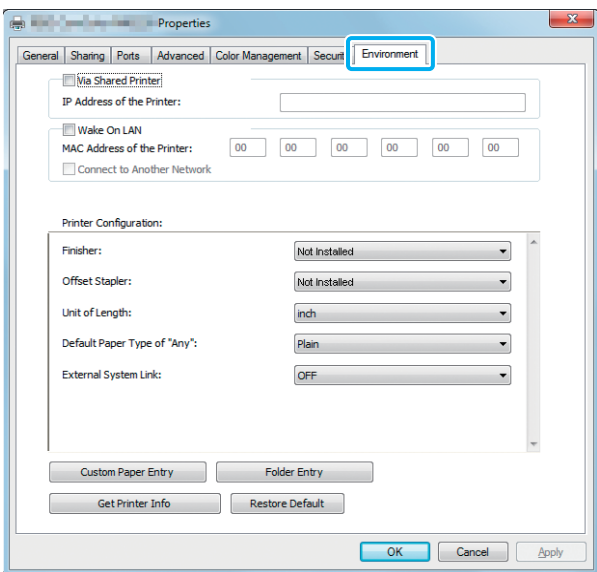

- Clicking [Restore Default] restores all settings on the tab to their default values.

Via a Shared Printer

Select this option to share the printer driver of the server computer to use this machine. Select the check box and enter the machine's IP address in the [IP address of the Printer] field. You can check the IP address of the printer on the [System Info] - [Machine Info] screen on the operation panel.

Configuring the MAC Address

Select [Get Printer Info] and click [Apply] to obtain the MAC address and display it in [MAC Address of the Printer]. To enter the MAC address manually, select the [Wake On LAN] check box and enter the MAC address in [MAC Address of the Printer] and select [Connect to Another Network].

[Connect to Another Network]

Normally, leave this check box unselected. Select this option when the printer's and computer's network segments are different.

Printer Configuration

Normally, click [Get Printer Info] to obtain the optional equipment configuration information from the printer automatically. The information obtained from the machine is displayed in [Printer Configuration]. The obtained information can also be changed manually.



- The information displayed on the screen varies depending on the optional equipment connected.

Configuring the Printer Configuration Automatically

Select [Get Printer Info] and click [Apply] to obtain the optional equipment configuration information from the printer and display it in [Printer Configuration].



- [Default Paper Type of "Any"] and [External System Link] are not configured automatically.

■ Configuring the Printer Configuration Manually

You can change the optional equipment configuration that you obtain from the printer.

Specify the following settings manually.

[Finisher]

Select the type of finisher that is connected to this machine.

[Face Down Finisher]

Select whether there is a face down finisher.

[Unit of Length]

Select whether to display the length in [mm] or [inch].

[Default Paper Type of "Any"]

Select the paper type to use when [Paper Type] under the [Basic] tab on the printer driver screen is set to [Any].

[External System Link]

Set this option to [ON] to enable and [OFF] to disable external system link.



- The machine changes the color profile according to the paper type. (p. 3-12 "Paper Type")
Even if a paper type is not specified, you must select one of the color profiles. Make your selection based on the administrator's recommendation.

Custom Paper Entry

Register up to 99 non-standard paper sizes.

The sizes registered here are displayed in [Original Size] and [Paper Size].

■ Configuring the Paper Size Automatically

You can use this option when the paper size is already registered in the printer.

1 Click [Custom Paper Entry].

The [Custom Paper Entry] dialog box is displayed.

2 Click [Get Printer Info].

The information of the paper size registered in the printer is displayed.

3 Click [Close].

The paper size information is saved.

■ Configuring the Paper Size Manually

1 Click [Custom Paper Entry].

The [Custom Paper Entry] dialog box is displayed.

2 Enter the paper width and length.

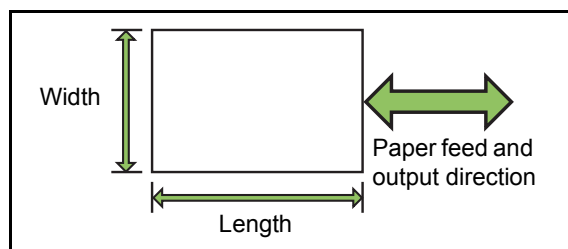

3 Enter a name for the paper size.

Enter a name up to 30 characters long.

4 Click [Add] to register the paper size.

5 Click [Close].

The paper size information is saved.

■ Saving the Paper Size to a Computer

You can save the registered paper size to a computer. It is useful to save settings to a computer when, for example, you want to share the registered paper size among multiple users or reinstall the printer driver.

1 Click [Custom Paper Entry].

The [Custom Paper Entry] dialog box is displayed.

2 Select the paper size to save from the list box.

3 Click [Save in File].

4 Specify the destination folder and file name.

5 Click [Save].

The selected paper size is saved.

■ Reading a Paper Size from a Computer

You can read and use a paper size saved to a computer.

1 Click [Custom Paper Entry].

The [Custom Paper Entry] dialog box is displayed.

2 Click [Open File].

3 Select the file with the paper size setting on the computer.

4 Click [Open].

The read paper sizes are displayed in the list on the [Custom Paper Entry] dialog box.

■ Deleting a Paper Size

1 Click [Custom Paper Entry].

The [Custom Paper Entry] dialog box is displayed.

2 Select the paper size to delete from the list box.

3 Click [Delete].

The selected paper size is deleted.

Folder Entry

You can register in the printer driver the folders to save the print data to. The shared folders and personal folders registered here are displayed as print data destination folders in [Output] under the [Basic] tab on the printer driver screen. (p. 3-12 "Output and Destination")



- If folder information cannot be obtained from the printer, the shared folders are displayed as "Shared folder 1" to "Shared folder 30".

■ Configuring a Folder Entry

1 Click [Folder Entry].

The [Folder Entry] dialog box is displayed.

2 Click [Get Printer Info].

The information of shared folders registered in the printer is displayed in [Shared Folder in the Printer].

3 Select the folder to add to [Registered Folder] and click [Add ->].

4 Configure the personal folder.

For personal folders, select the [Use Personal Folder] check box.

5 Click [Apply].

6 Click [OK].

Print Mode Function Buttons

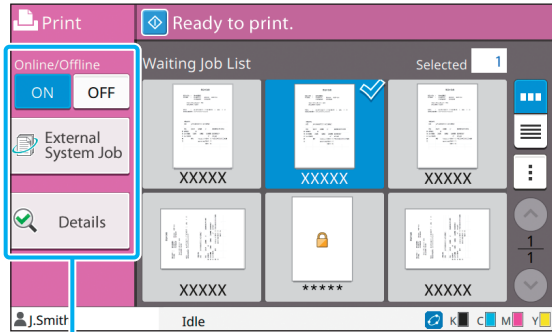

Function buttons

Online / Offline

You can switch the network connection status (online/offline). When this setting is set to [OFF], the machine does not accept print orders from computers.

The [OFF] option should be used when using this machine exclusively.

[OFF], [ON]



- When this setting is set to [OFF], [✖] is displayed. (p. 15 "[Home] Screen")
- If the user does not return this setting to [ON] after printing their job, the setting automatically returns to [ON] in the following cases.
 - When auto reset is executed (The auto reset timing is set by the administrator.)
 - When you log out

External System Job

When using an external system link, you can print jobs saved on an external system.

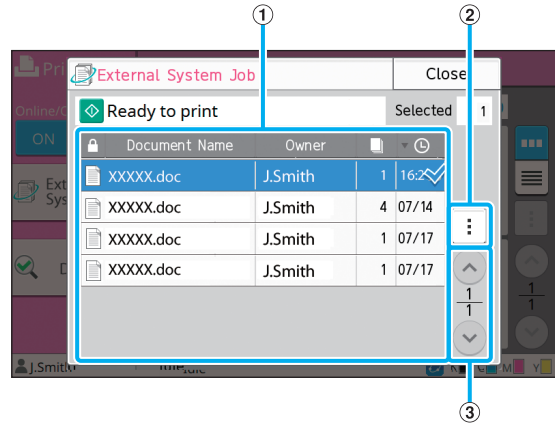

① View

External system jobs are listed. The job list displays the document name, owner name, number of copies, and receiving date/time.

② Sub menu

The following settings can be configured from the sub menu.

- Delete
- Check Amount

③ ▲/▼ buttons

Use these buttons to switch the view pages.

The current page and total number of pages are displayed as a fraction.

Details

You can check the details of the selected document.

1 Touch [Details].

The [Details] screen is displayed. Check the details of the selected document.

The following settings can be configured from the sub menu.

- Print This List

2 Touch [Close].

Change Setting

To check job settings, select the job and touch [Change Setting] in the sub menu.

Paper Selection

Select a paper tray.
You can also change the tray settings (paper size, paper type, double-feed check, and auto selection).
For more information, see "Paper Selection" (p. 1-7) in "Copy".

Print Density

You can adjust the print density.
For more information, see "Print Density" (p. 1-10) in "Copy".

Image Position

This function adjusts the printing position of images.
For more information, see "Image Position" (p. 1-18) in "Copy".

Slow Printing

This option slows down the printing speed as well as reduces the operating sound of the job being processed.

For more information, see "Slow Printing" (p. 1-22) in "Copy".

You can save the scanned data in folders for printing as necessary.

Overview of Storage Operations (Save)..... p. 4-2

1. Load the original.
- ↓
2. Select [Storage] - [Save] on the [Home] screen.
- ↓
3. Select a folder to save the data to.
- ↓
4. Press the [Start] key.

Overview of Storage Operations (Load)..... p. 4-3

1. Select [Storage] - [Load] on the [Home] screen.
- ↓
2. Select a folder.
- ↓
3. Select a document.
- ↓
4. Enter the number of copies using the numeric keys.
- ↓
5. Press the [Start] key.

Storage Mode Function Buttons p. 4-6

This section explains the functions available in Storage mode.



4



Storage

Overview of Storage Operations

This section explains the basic storage operations.

Saving the Data to a Folder

You can save the scanned data to a folder.

1 Load the original.

For more information on the types of originals that can be used, see "Originals" in the "Safety Information".

■ In the ADF

1 Load the original in the ADF.

Align the originals and place them face up.

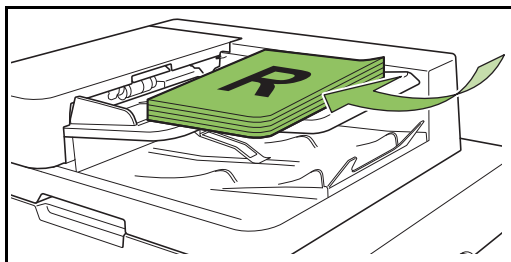

2 Slide the original guides to match the width of the originals.

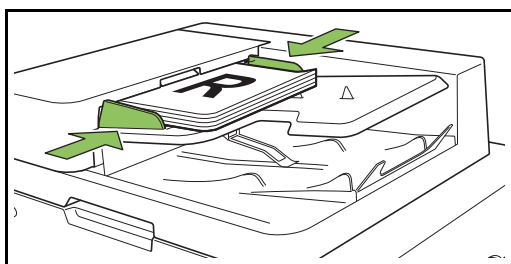

■ On the Platen Glass

1 Open the original cover.

2 Load the original.

Load the original face down on the glass. Align the corner of the original with the upper-left corner of the glass.

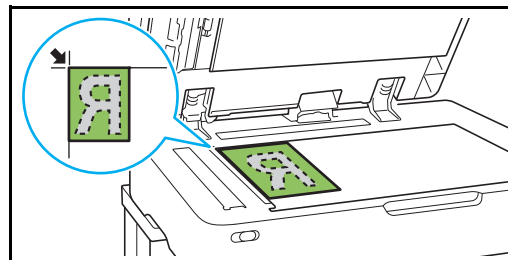

3 Close the original cover.

• Open and close the original cover gently.

2 Select [Storage] - [Save] on the [Home] screen.

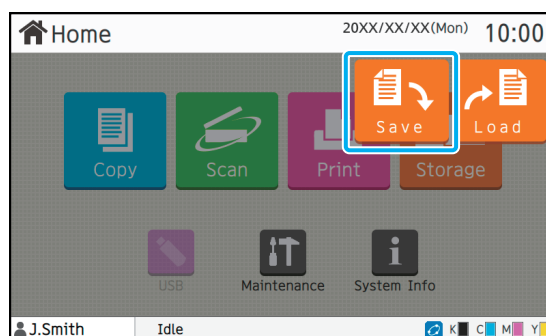

- 3 Select a folder to save the data to.

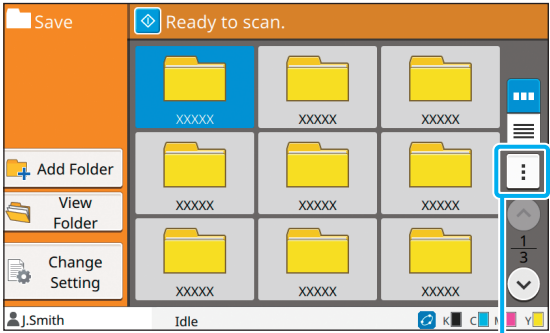

Sub menu

The folder list shows personal folders. It also shows shared folders, access to which is managed by the administrator.

The following settings can be configured from the sub menu.

- Change Color
- Rename

- 4 Press the [Start] key.

Printing a Document in a Folder

You can print a document that is saved in a folder.

- 1 Select [Storage] - [Load] on the [Home] screen.

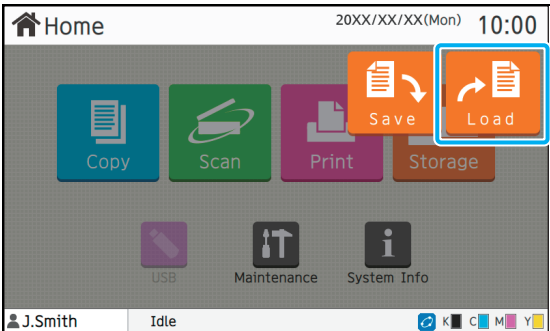

- 2 Select the folder that you want to use and touch [Open].

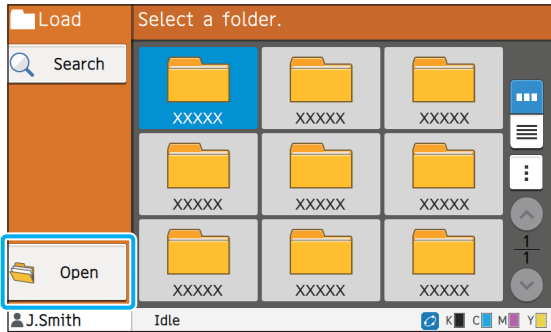

The folder list shows personal folders. It also shows shared folders, access to which is managed by the administrator.

- 3 Select the document that you want to print.

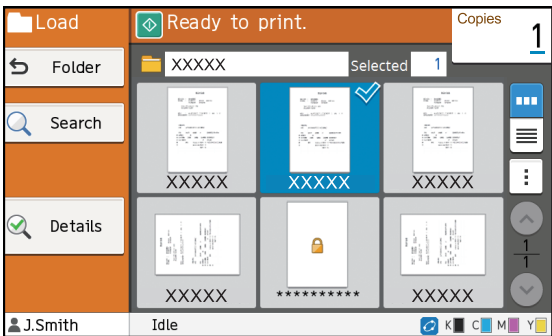

The selected document has a check mark.

- 4 Enter the number of copies using the numeric keys.
- 5 Press the [Start] key.

! Documents saved in a folder are digitized along with their settings. When printing these documents, use the same paper type as that used when saving the data in the folder.

List of Settings in [Storage] - [Save]

Select a folder on the [Storage] - [Save] screen and touch [Change Setting] to display the settings. The following is a list of settings that are available on this screen.

Setting item	Description	See
Document Name	View/Specify the document names when saving the document data to a folder.	p. 2-6
Color Mode	Select color or monochrome printing.	p. 1-7
Reproduction Size	Use this to reduce or enlarge the copied image.	p. 1-7
Paper Selection	Change the paper tray, paper type, and feed control settings according to the copying paper.	p. 1-7
Scanning Size	Specify the scanning size for originals.	p. 1-9
Original Orientation	Specify the orientation of the original.	p. 1-9
Duplex / Simplex	Specify the sides of the original to be read and the sides of the paper to be printed on.	p. 1-10
Sort	Specify the printing mode for making multiple copies of the original.	p. 1-10
Scanning Level	Adjust the scanning level.	p. 1-10
Print Density	Specify the print density.	p. 1-10
ADF Scan & Pause	Use this option to copy as one job even when having to load the original in multiple sets due to the large number of pages in the original.	p. 1-11
Mixed Size Original	Use this option when multiple different original sizes are used in the original.	p. 1-11
Book Shadow Erasure	Remove shadows that appear in the center of copies when an open book is copied.	p. 1-12
Page Split	Use this option to scan double-spread pages and split them into two parts (right and left).	p. 1-12
Combine	Use this option to impose continuous pages onto one sheet.	p. 1-13
Image Repeat	This imposes multiple copies of the same original onto one sheet.	p. 1-13
Booklet	Specify the imposition when creating a booklet.	p. 1-14
PIN Code	Specify whether to apply a PIN code to a job. If a PIN code is used on a document, the PIN code is required to print or delete that document.	p. 2-9
Stamp	Use this option to print the page number and date in the header or footer area.	p. 1-14
Page Border	Use this option to add a frame line in the margins of the paper.	p. 1-16
Image Quality	Specify the resolution for scanning originals.	p. 1-16
Original Type	Select the original type so that the appropriate image processing is performed before printing the scanned data.	p. 1-16
Gamma Correction	Use this option to correct the color balance (CMYK) of the scanned data.	p. 1-17
Image Control	Specify the image processing of the original.	p. 1-17
Base Color Level	Make the background color (base color) lighter so that the text is easier to read.	p. 1-18
Image Position	Specify this when adjusting the print position.	p. 1-18
Program	Specify this when the number of required copies varies by group (such as corporate division or classes). You can quickly print exactly the number of copies of the number of sets you need.	p. 1-18

Setting item	Description	See
Add Cover	Specify this to add front and back covers to the front and back of the printout.	p. 1-20
Separation	Configure the settings for slip sheets. When the optional finisher is connected, the offset output setting is also available.	p. 1-21
Binding Margin	Specify whether to print with a binding margin. You can set the binding edge and binding margin values.	p. 1-22
Staple	Configure the staple settings. (When using the optional face down finisher)	p. 8-6
Slow Printing	Use this option to slow down the printing speed. This also reduces the operating sound of the job being processed.	p. 1-22
Output Tray	Select the output tray for printouts. (When using the optional stacking tray)	p. 8-11
Output Tray Relay	Use this option to automatically switch the output tray when it becomes full. (When using the optional auto-control stacking tray)	p. 8-11
Paper Tray Relay	Use this option to automatically feed paper from a different tray with the same paper size and paper type when the selected tray runs out of paper.	p. 1-22
Auto Image Rotation	Rotate the image 90 degrees automatically when the orientation of the original and paper do not match.	p. 1-22
Folder	Display the folder list screen.	p. 4-6
Favorites	This function calls frequently used settings.	p. 4-6
Check Setting	Use this option to check the current settings. You can check the preview of the scanned data.	p. 4-6
Custom Menu	Register favorites and default settings, and edit the button order.	p. 4-6

List of Settings in [Storage] - [Load]

Select a folder on the [Storage] - [Load] screen and touch [Open] to display a list of all documents in that folder. Select a document and touch [Change Setting] in the sub menu to display the settings screen. The following is a list of settings that are available on this screen.

Setting item	Description	See
Paper Selection	Change the paper tray, paper type, and feed control settings according to the paper to be copied.	p. 1-7
Print Density	Specify the print density.	p. 1-10
Image Position	Specify this when adjusting the print position.	p. 1-18
Slow Printing	This option slows down the printing speed as well as reduces the operating sound of the job being processed.	p. 1-22

Storage Mode Function Buttons

Function Buttons in [Storage] - [Save]

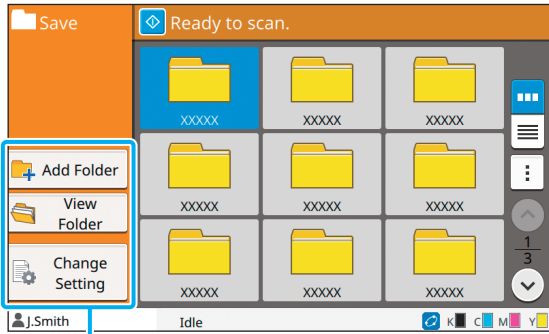

Function buttons

Add Folder

You can add a new folder.

1 Touch [Add Folder].

The [Folder Name] screen is displayed.

2 Enter the folder name and touch [OK].



- For more information on text input, see "Entering Text" (p. 24) in "Touch Panel".
- You can use both upper and lower case letters.
- If there is already a folder with the same name, a confirmation screen is displayed with a message indicating that the entered folder name cannot be registered.

View Folder

This function displays a list of documents in the selected folder.



- Touch [Document Name], [Owner] or [Save Date] to switch the sorting order between ascending and descending for display.

Change Setting

You can change the settings for saving a document to a folder.

For more information on the setting buttons, see "List of Settings in [Storage] - [Save]" (p. 4-4).

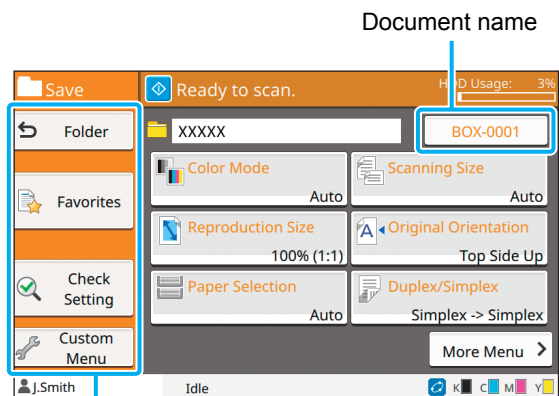

Function buttons

■ Folder

Touch this button to display the folder list screen.

■ Favorites

Touch this button to call registered settings.

For more information, see "Favorites" (p. 1-24) in "Copy".

■ Check Setting

You can view the settings for the document to be saved.

For more information, see "Check Setting" (p. 2-10) in "Scanning".

■ Custom Menu

You can register favorites and default settings, and edit the button order.

For more information, see "Custom Menu" (p. 1-25) in "Copy".

Document Name

Touch the document name button to specify the document name when saving a document to a folder. For more information, see "Document Name" (p. 2-6) in "Scanning".



- The owner's name cannot be added to the document name.

Function Buttons in [Storage] - [Load]

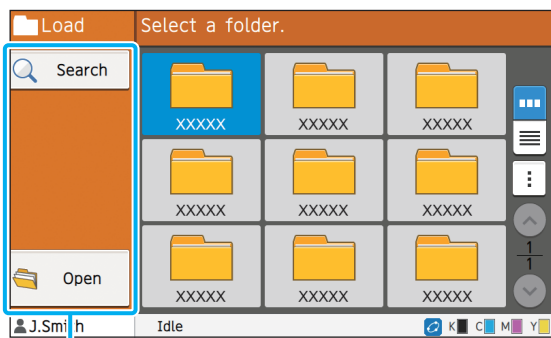

Function buttons

Search

Touch this button to search documents in all folders.

1 Touch [Search].

The [Search] screen is displayed.

2 Enter a text string that you want to search for and touch [OK].



- For more information on text input, see "Entering Text" (p. 24).
- In the following cases, the job name is displayed as "*****".
 - Jobs with the [Hide Job Name] check box selected on the printer driver (p. 3-24 "PIN Code")
 - Jobs that belong to users other than the user currently logged in when [Job Name Display] is set to [OFF] on the administrator menu

Open

Touch this button to display a list of documents in the folder.

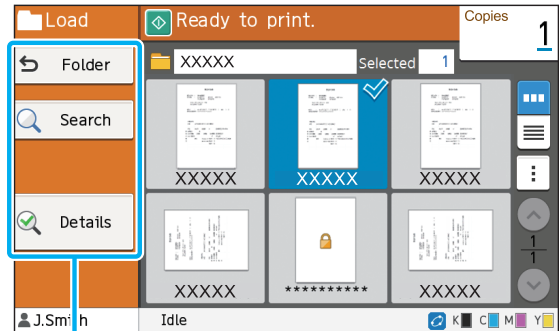

Function buttons

Folder

Touch this button to display the folder list screen.

Search

Touch this button to search documents in the opened folder.

Details

Touch this button to check the details of the selected document. You can print this list from the sub menu.

Sub menu

The following settings can be configured for selected documents.

- Change Setting
- Rename
- Delete
- Copy to USB Drive (p. 4-8)
- Copy to Folder (p. 4-8)

■ Copy to USB Drive

The documents saved in a folder can be copied to a USB flash drive.

- 1 Insert a USB flash drive into the USB slot.

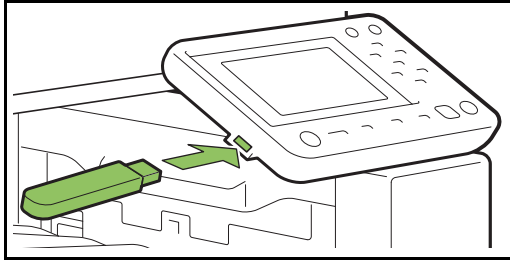

- 2 Display the sub menu and touch [Copy to USB Drive].

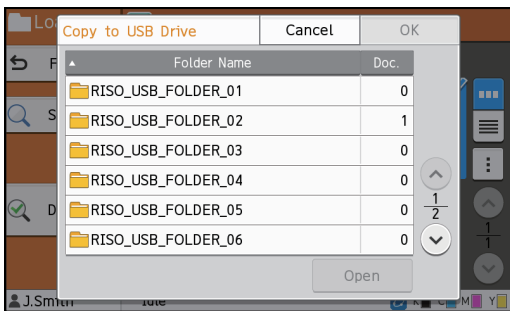

- 3 Select the folder that you want to save the document to and touch [OK].

- If the USB flash drive does not have a folder when [OK] is touched, a folder is automatically generated to copy the document.
- Select a folder and touch [Open] to display a list of all documents in that folder.

■ Copy to Folder

The documents saved in a folder can be copied to another folder.

- 1 Display the sub menu and touch [Copy to Folder].

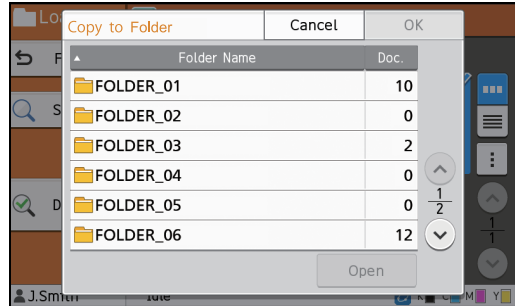

- 2 Select the folder that you want to save the document to and touch [OK].

- Only the folders accessible to the logged-in user are displayed on the [Copy to Folder] screen.
- Select a folder and touch [Open] to display a list of all documents in that folder.

You can save the scanned data to a USB flash drive connected to this machine.
You can also print documents that is saved on a USB flash drive from the printer driver.

Overview of USB Operations (Save)..... p. 5-2

1. Insert a USB flash drive into the USB slot.



2. Load the original.



3. Select [USB] - [Save] on the [Home] screen.



4. Change the settings.



5. Press the [Start] key.

Overview of USB Operations (Load).....p. 5-3

1. Insert a USB flash drive into the USB slot.



2. Select [USB] - [Load] on the [Home] screen.



3. Select a folder.



4. Select a document.



5. Enter the number of copies using the numeric keys.



6. Press the [Start] key.

USB Mode Function Buttonsp. 5-6

This section explains the functions available in USB mode.



5



USB

Overview of USB Operations

This section explains the basic operations in USB mode.

Saving the Scanned Data to a USB Flash Drive

You can save the scanned data to a USB flash drive.

- **1 Insert a USB flash drive into the USB slot.**

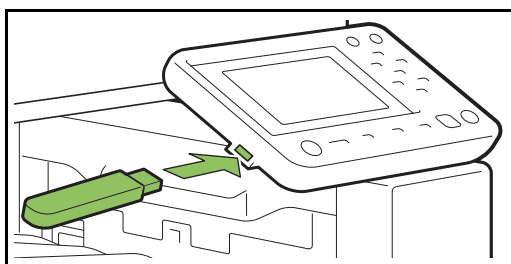

- **2 Load the original.**

For more information on the types of originals that can be used, see "Originals" in the "Safety Information".

■ In the ADF

- 1 Load the original in the ADF.**

Align the originals and place them face up.

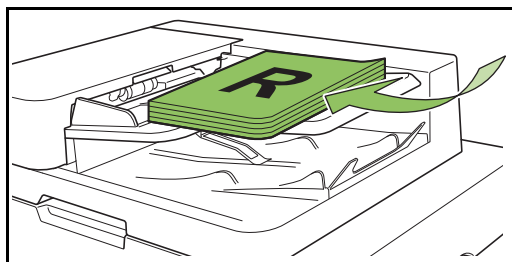

- 2 Slide the original guides to match the width of the originals.**

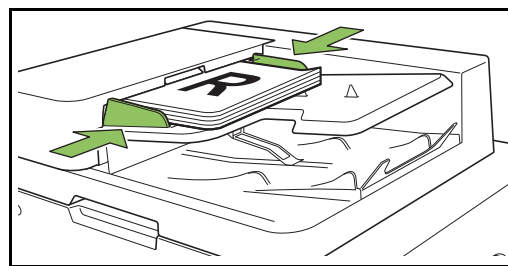

■ On the Platen Glass

- 1 Open the original cover.**
- 2 Load the original.**

Load the original face down on the glass. Align the corner of the original with the upper-left corner of the glass.

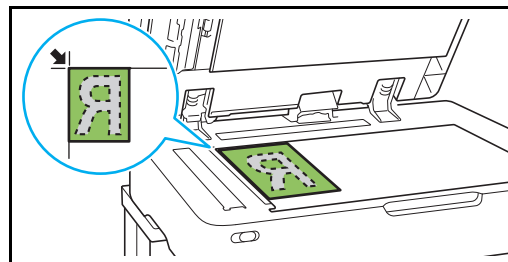

- 3 Close the original cover.**



• Open and close the original cover gently.

- 3 Select [USB] - [Save] on the [Home] screen.

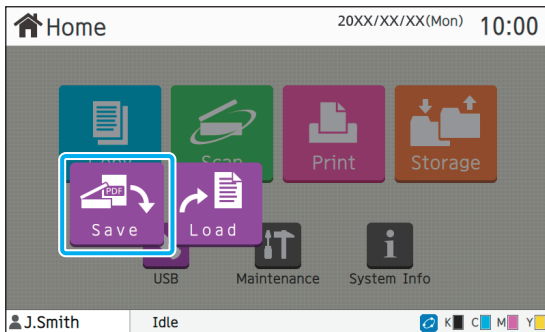

- 4 Change the settings.

Specify the detailed settings for scanning. For more information on the functions that can be configured, see "List of Settings in [USB] - [Save]" (p. 5-4).

- 5 Press the [Start] key.

Printing a Document Saved on a USB Flash Drive

You can print a document that is saved on a USB flash drive.

For specific instructions on how to save a document to a USB flash drive, see "Output and Destination" (p. 3-12) in "Print".



- Only PRN-format files can be printed.
- A PRN file is a dedicated file format in which data is output via the printer driver. This type of file can only be opened on a RISO printer or application.
- If you are using the optional PostScript kit, you can also use PDF files. For more information, see "Printable Files in the USB Flash Drive" (p. 8-22) in "Optional Equipment".

- 1 Insert a USB flash drive into the USB slot.

- 2 Select [USB] - [Load] on the [Home] screen.

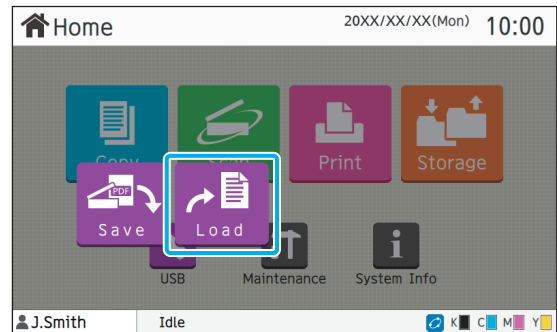

- 3 Select the folder that you want to use and touch [Open].

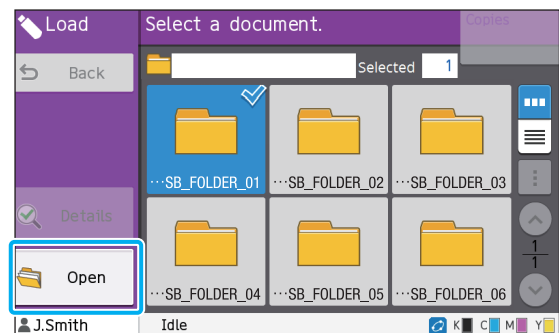

5

- 4 Select the document that you want to print.

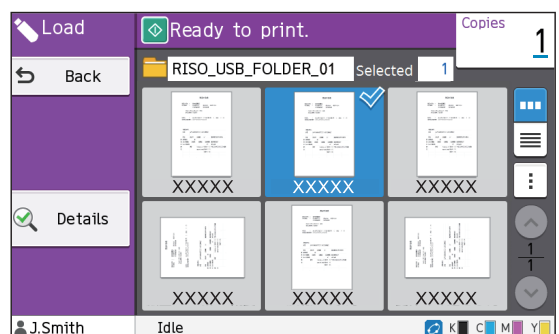

The selected document has a check mark.

- 5 Enter the number of copies using the numeric keys.
- 6 Press the [Start] key.

List of Settings in [USB] - [Save]

The following is a list of settings available on the [USB] - [Save] screen.

Setting item	Description	See
Document Name	View/Specify the document names when saving the document data to a USB flash drive.	p. 2-6
Color Mode	Specify the color mode of the data to be scanned.	p. 2-7
Scanning Size	Specify the scanning size for originals to be scanned.	p. 2-7
File Format	Specify the file format, compression level and resolution for saving the scanned data.	p. 2-7
Duplex / Simplex	Specify the sides of the original to be scanned.	p. 2-8
Scanning Level	Adjust the scanning level.	p. 1-10
Original Orientation	Specify the orientation of the original.	p. 1-9
Resolution	Specify the resolution for scanning originals.	p. 2-8
Mixed Size Original	Use this option when multiple different original sizes are used in the original.	p. 1-11
Book Shadow Erasure	Remove shadows that appear in the center of copies when an open book is copied.	p. 1-12
Page Split	Use this option to scan double-spread pages and split them into two parts (right and left).	p. 1-12
Original Type	Select the original type to perform the appropriate image processing and save the scanned data.	p. 2-9
Gamma Correction	Use this option to correct the color balance (CMYK) of the scanned data.	p. 2-9
Image Control	Specify the image processing appropriate for the original.	p. 1-17
Base Color Level	Make the background color (base color) lighter so that the text is easier to read.	p. 1-18
Favorites	This function calls frequently used settings.	p. 5-6
Check Setting	Use this option to check the current settings. You can check the preview of the scanned data.	p. 5-6
Custom Menu	Register favorites and default settings, and edit the button order.	p. 5-6

List of Settings in [USB] - [Load]

Select a folder on the [USB] - [Load] screen and touch [Open] to display a list of all documents in that folder. Select a document and touch [Change Setting] in the sub menu to display the settings screen.

The following is a list of settings that are available on this screen.

Setting item	Description	See
Paper Selection	Change the paper tray, paper type, and feed control settings according to the copying paper.	p. 1-7
Print Density	Specify the print density.	p. 1-10
Image Position	Specify this when adjusting the print position.	p. 1-18
Slow Printing	This option slows down the printing speed. This also reduces the operating sound of the job being processed.	p. 1-22



- If the optional PostScript kit is installed, PDF files saved on a USB flash drive can also be used. In this case, you can change the settings for printing PDF files. For more information, see "Printable Files in the USB Flash Drive" (p. 8-22) in "Optional Equipment".

USB Mode Function Buttons

Function Buttons in [USB] - [Save]

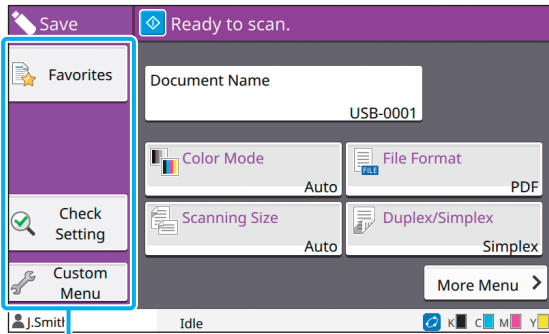

Function buttons

Favorites

Touch this button to call registered settings. For more information, see "Favorites" (p. 1-24) in "Copy".

Check Setting

You can view the settings for the document to be saved. For more information, see "Check Setting" (p. 2-10) in "Scanning".

Custom Menu

You can register favorites and default settings, and edit the button order. For more information, see "Custom Menu" (p. 1-25) in "Copy".

Document Name

Display the document names when saving the document data to a USB flash drive. Touch [Document Name] to set the document naming settings. For more information, see "Document Name" (p. 2-6) in "Scanning".

Function Buttons in [USB] - [Load]

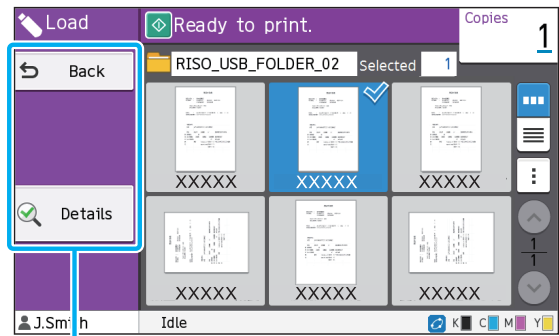

Function buttons

Back

Touch this button to display the upper directory of the document list.

Details

Touch this button to check the details of the selected document.

The following settings can be configured from the sub menu on the details screen.

- Print This List

When you select the document on the document list screen, the following settings can be configured from the sub menu.

- Change Setting
- Copy to Folder (p. 5-7)



- Touch [Name] or [Doc.] to switch the sorting order between ascending and descending for display.

■ Copy to Folder

Documents saved on a USB flash drive can be copied to a folder on this machine.

1 Display the sub menu and touch [Copy to Folder].

2 Select the folder that you want to save the document to and touch [OK].



- You cannot copy documents from a folder on the USB flash drive to another folder on the USB flash drive.
- Only the folders accessible to the logged-in user are displayed on the [Copy to Folder] screen.
- Select a folder and touch [Open] to display a list of all documents in that folder.

RISO Console

The RISO Console is software that uses a Web browser to remotely control this machine. With a computer connected to the printer via a network, you can check the printer status, change the settings of a job, and perform other operations.

Overview of the RISO Consolep. 6-2

Starting the RISO Console



Common Button Operations

[System Info] Menup. 6-6

This section explains the functions available on the [Consumables], [Machine Info], [User Info], and [License Info] screens.

[Scan] Menup. 6-9

This section explains the functions available on the [Scan] menu.

[Print] Menup. 6-10

This section explains the functions available on the [Print] menu.

[Storage] Menup. 6-11

This section explains the functions available on the [Storage] menu.

[Job Status] Menup. 6-12

This section explains the functions available on the [Job Status] menu.

[Maintenance] Menup. 6-13

This section explains the functions available on the [Maintenance] menu.



6



RISO Console

Overview of the RISO Console

This section explains the functions of the RISO Console.

Top Screen

- Make sure the machine is connected to the network.

Status pane

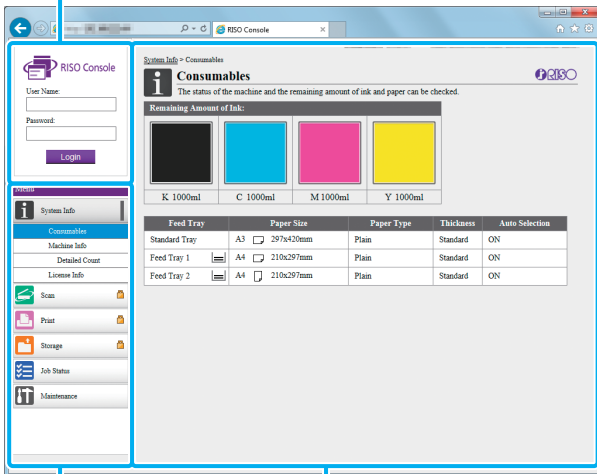

Side menu

Content pane

- When an item on the side menu has the icon, this indicates that you must log in before you can access that item. When an item is displayed with the icon after logging in, the access to the mode is restricted.
- The mark is displayed on the left side of the screen while information on the machine is being collected.



- The supported Web browsers are as follows.
 - Windows® Internet Explorer Ver. 7.0
 - Windows® Internet Explorer Ver. 8.0
 - Windows® Internet Explorer Ver. 10.0
 - Windows® Internet Explorer Ver. 11.0
 - Safari® (for OS X)
- The RISO Console screen is not displayed when using certain power saving settings. Contact your administrator for details.

Side Menu

The information and the functions that are available on the side menu of the RISO Console are as listed below.

System Info		
Consumables	View the status of the consumables, such as the remaining amount of ink or paper.	p. 6-6
Machine Info	<ul style="list-style-type: none"> • View the status of the printer. • View the printer model, serial number, MAC address, and other system information. • View the detailed count and meter reading report. 	p. 6-6
User Info	View information about the user currently logged in.	p. 6-7
License Info	View the license information of the system used in this product.	p. 6-8

Scan		
Search, view, delete, or download scan jobs that are saved on the internal hard disk of this machine.		p. 6-9
Print		
View or delete jobs.		p. 6-10
Storage		
Load	<ul style="list-style-type: none"> • Search documents in a folder. • Edit folders (add, change color, etc.) 	p. 6-11
Form Data	Search, view, print, or delete jobs that are output via [Form] from the printer driver. (when the optional PostScript kit is installed)	p. 8-22
Job Status		
Active/Idle	Search, view, or delete jobs that are being processed or waiting.	p. 6-12
Finished	Search, view, delete, or re-print jobs that have finished.	p. 6-12
Maintenance		
Head Cleaning	Execute head cleaning.	p. 6-13

Starting the RISO Console

Connect the computer to the network before starting the RISO Console. Connection to the Internet is not required.

- 1 Start your Web browser.**
- 2 Enter the IP address of the printer in the address box of your Web browser.**

To view the IP Address of the printer, select [Machine Info] in [System Info] on the operation panel of this machine.

<Example of how to enter the IP address "192.168.1.99">

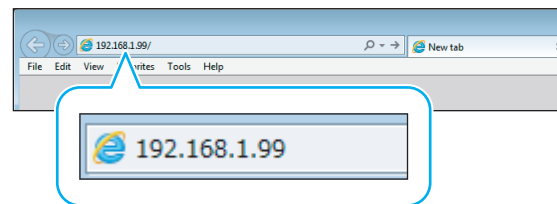

- 3 Press the [Enter] key.**

The [System Info] screen of the RISO Console is displayed.



- You can create a shortcut on the desktop to quickly bring up the RISO Console.

Logging In

When an item on the side menu has the  icon, this indicates that you must log in before you can access that item.

1 Enter your user name and password in the status pane.

Your password should consist of 0 to 16 characters (numbers and/or lower case letters). The entered characters are displayed with asterisks (*).

2 Click [Login].

The [System Info] - [Consumables] screen is displayed.

Logging Out

Click [Logout] in the status pane.



- If you forget your password, contact your administrator.
- You can change the user password on the [System Info] - [User Info] screen. (p. 6-7 "[User Info] Screen")

Common Button Operations

The [Scan] menu screen, [Print] menu screen, [Storage] menu screen, and [Job Status] screen have common buttons that serve the same purposes.

The [Scan] menu screen is used here as an example to explain the respective functions.

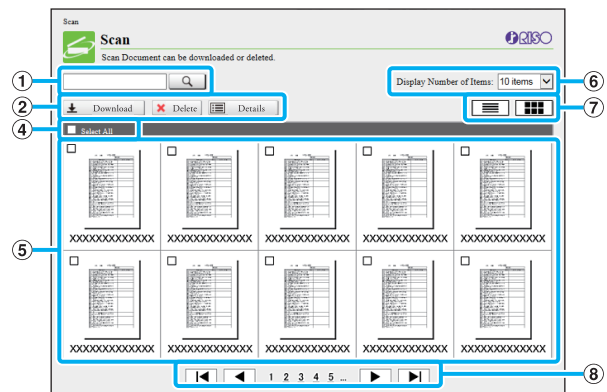

Thumbnail display

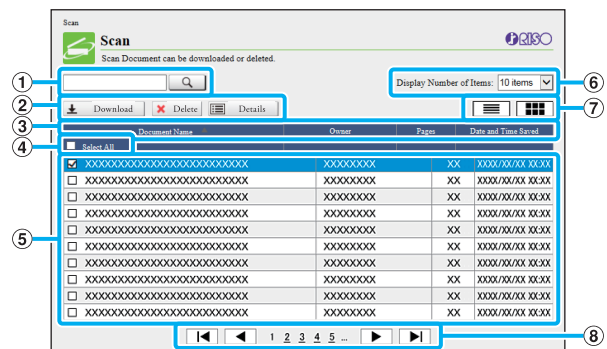

List display

① Search

Use this function to search jobs.
You can use up to 256 characters long.

② Menu

Select a job and click a menu option.
The menu options displayed depend on the screen.

③ Title bar (list display only)

You can sort jobs by clicking an item in the title bar ([Document Name], [Owner], [Pages], or [Date and Time Saved]).

④ Select All

Select this option if you want to select all jobs.



⑤ Jobs

To select a job, click the job name to add a check mark.



⑥ Number of jobs displayed on a page



Select the number of jobs to be displayed on a page.

⑦ Display switching ([Scan] screen and [Print] screen only)

Click  or  to switch between list and thumbnail display.

⑧ Page switching

 or  : Moves to the first or last page.

 or  : Moves to the previous or next page.

1 2...: Moves to the specified page that you click.



- If you select a job with a PIN code assigned, the PIN code input screen is displayed. Enter the PIN code and click [OK].
- You can select more than one job.
- If the job name, owner, or folder name exceeds the maximum displayable number of characters, they are displayed with the first part of the name omitted and replaced with "...".

[System Info] Menu

[Consumables] Screen

This screen displays information on the ink and paper.

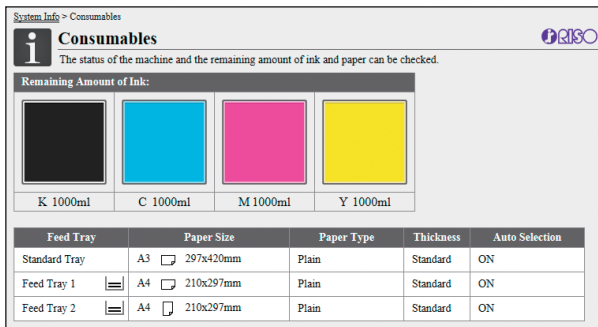

Remaining Amount of Ink

The remaining amount of ink is displayed in 10 levels for each ink cartridge.

The indicator starts flashing when the time to replace an ink cartridge comes close.

Prepare a new ink cartridge for the color that flashes.



- The remaining amount of ink is indicated based on the bottle capacity.
- If you are not using RISO ink, the remaining amount of ink is not displayed.

Paper Status

The estimated remaining amount of paper, paper size, paper type, thickness, and whether Auto Selection is ON are all displayed for each tray.

The remaining amount of paper is displayed in 3 levels for Feed Trays 1 and 2 (51-100%, 1-50%, and 0%). When 0% is displayed, this indicates that there is no paper. Load paper.

There is no paper status indicator for the standard tray.

For the paper settings, see "Changing the Paper Tray Setting" (p. 1-8) in "Copy".

[Machine Info] Screen

This screen displays the status of this machine, the connection status of optional equipment, serial number, used space on the internal hard disk and other system-related information.

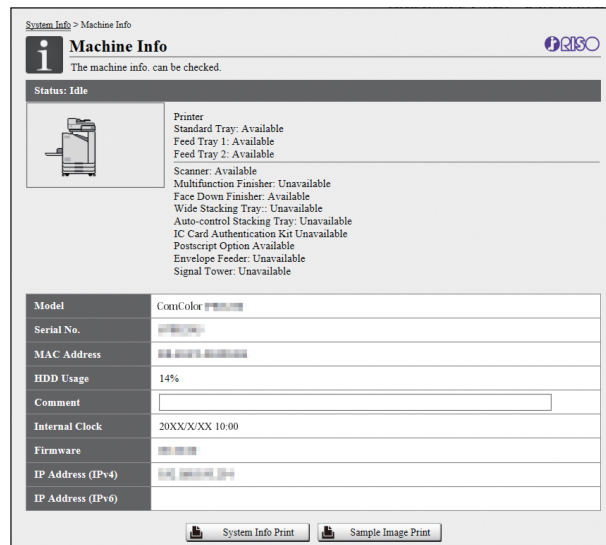

Machine Status

The status of this machine, availability of trays, and connection status of optional equipment are all displayed. If an error occurs, the error message is displayed.

Machine Info

Model: Machine model.

Serial No.: Machine serial number.

MAC address: Machine MAC address.

HDD Usage: Ratio of used internal hard disk space.

Comment: Comments entered by the administrator.

Only a user with the administrator account can enter comments.

Internal Clock: Date and time of the machine's internal clock.

Firmware: Version of the firmware.

IP Address (IPv4): IPv4 address assigned to this machine.

IP Address (IPv6): IPv6 address assigned to this machine.

[System Info Print]

Click this to print the system information.

[Sample Image Print]

Click this to print a sample page so you can check the result of a printed image.

Checking the Detailed Count

The total count of prints and copies of this machine and the count for each paper size are displayed.

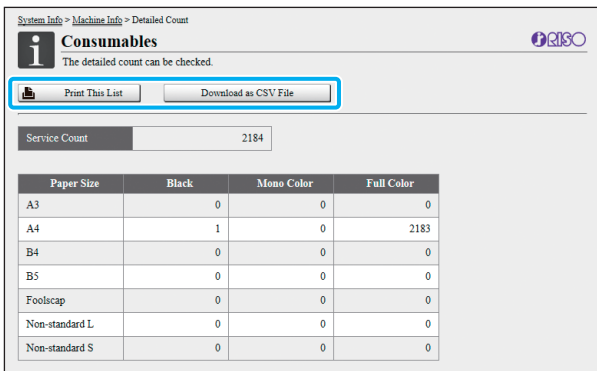

[Print This List]

Click this to print the latest information.

[Download as CSV File]

Click this to save the latest information to a computer as a CSV file.

Service Count

The total number of prints and copies made with this machine is displayed.

Detailed Count

The count for each paper size is displayed.

- When you click [Print This List] or [Download as CSV File], the latest information is obtained and may be different from the information displayed on the screen.

Checking the Charge Count

The charge count for each paper size division is displayed separately for monochrome and color.

[Print This List]

Click this to display the latest information.

[Download as CSV File]

Click this to save the latest information to a computer as a CSV file.

Meter Reading Report Setting

The charge type is displayed.



- The [Meter Reading Report] screen is only displayed when using ComColor FW5230R/ FW5231R/FW5000R.
- When you click [Print This List] or [Download as CSV File], the latest information is obtained and may be different from the information displayed on the screen.
- For more information on the charge counting, contact your dealer or authorized service representative.

[User Info] Screen

The information about the users currently logged in is displayed.

- If login is unnecessary, the [User Info] screen is not displayed.

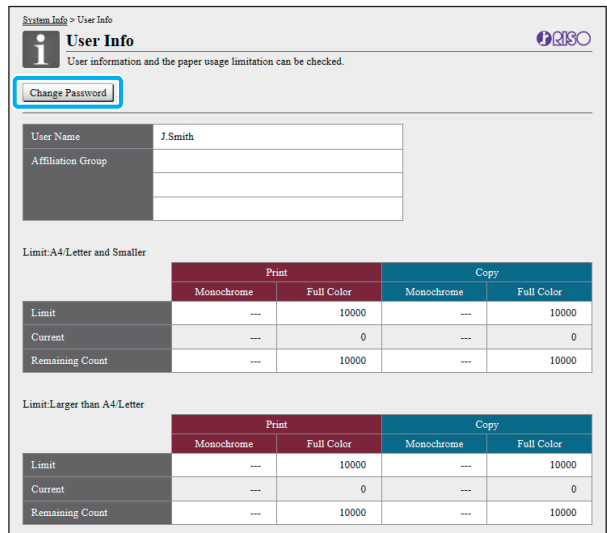

[Change Password]

You can change the password.

User Info

This screen displays the user names and groups of the users logged in.

Limits

The printable and copyable limits established by the administrator and the current number of printouts and copies made by the user logged in are displayed.



- The information displayed is registered by the administrator. If the facts are different from the information displayed, contact your administrator.

Changing the Login Password

Users can change their own login passwords.

- 1 Click [Change Password].**
- 2 Enter the new password in [New Password].**

Your password should consist of 0 to 16 characters (numbers and/or lower case letters). The entered characters are displayed with asterisks (*).
- 3 Enter the new password again for confirmation.**
- 4 Click [OK].**

The screen is displayed to indicate that the settings are sent.
- 5 Click [OK].**

[License Info] Screen

The [License Info] screen displays information about the license of the system used in the machine.

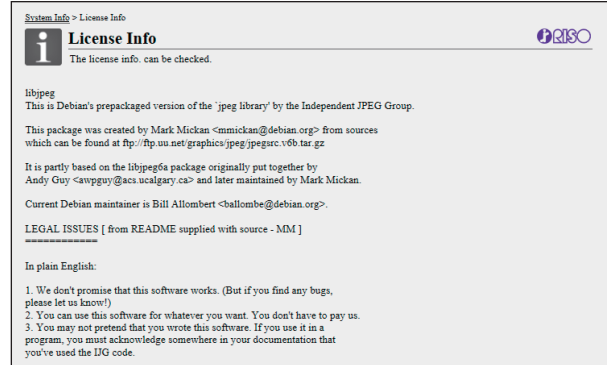

[Scan] Menu

[Scan] Menu Screen

You can download the scanned data saved on the internal hard disk of this machine to a computer.

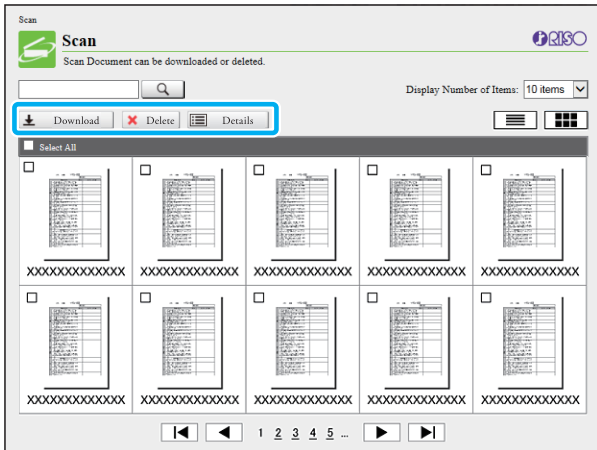

[Download]

Download the selected job.

[Delete]

Delete the selected jobs.

[Details]

You can view the settings, file capacity, and other information on the selected job.



- The storage period for scanned jobs is configured by the administrator with [Scan Document Save Setting]. When that period is reached, the job is deleted automatically.

Downloading Scanned Jobs to a Computer

1 Select the check box of the scanned job to download.

You can select more than one job.

2 Click [Download].

The screen indicating that a zip file is being created is displayed.

- For jobs with a PIN code, the PIN code input screen is displayed. Enter the PIN code and click [OK].

3 Click the link to the zip file.

The [Save As] dialog box is displayed.

4 Specify the destination folder and file name, and then click [Save].

The scanned data is saved to the computer.

[Print] Menu

[Print] Menu Screen

You can check the status of jobs that are sent from the printer driver and saved on the internal hard disk of this machine.

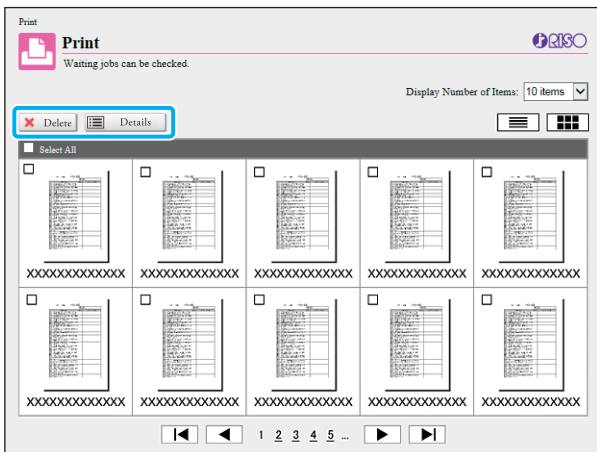

[Delete]

Delete the selected jobs.

[Details]

You can view the settings, file capacity, and other information on the selected job.



- In the following cases, all job names are displayed in the list.
 - When user login is not required
 - When the user is logged in with the administrator account
- In the following cases, the job name is displayed as "*****".
 - Jobs with the [Hide Job Name] check box selected on the printer driver (p. 3-24 "PIN Code")
 - Jobs that belong to users other than the user currently logged in when [Job Name Display] is set to [OFF] on the administrator menu

[Storage] Menu

[Load] Screen

The shared folders and personal folders are displayed.

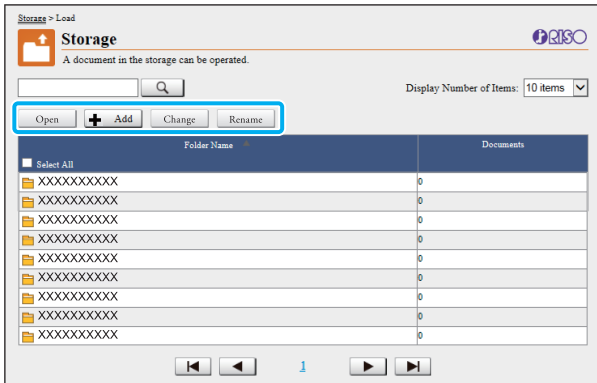

[Open]

Click this button to display a list of documents in the folder.

[Add]

Click this button to add a folder.

A folder name can be entered using up to 128 characters long.

[Change Color]

Click this button to change the color of the selected folder.

[Rename]

Click this button to change the name of a folder.

A folder name can be entered using up to 128 characters long.



- The functions may not be available, depending on how the administrator has configured the settings.

Managing Documents in a Folder

[Close]

Close the document list screen and display the [Load] screen.

[Print]

Print the selected documents.

[Delete]

Delete the selected documents.

[Copy to Folder]

Select the folder that you want to copy to, and click this button to copy the documents.

[Details]

Click this button to view the settings for the selected document. You can also change the settings.

[Download]

If the optional PostScript kit is installed, you can save the selected PostScript jobs to a computer.

1 Select a folder and click [Open].

The screen displays a list of documents in that folder.

2 Operate documents.

The following functions are available for selected documents.

- Print
- Delete
- Copy to Folder
- Details
- Download

[Job Status] Menu

[Active / Idle] Screen

The jobs that are being printed and the jobs that are waiting to be printed are displayed.

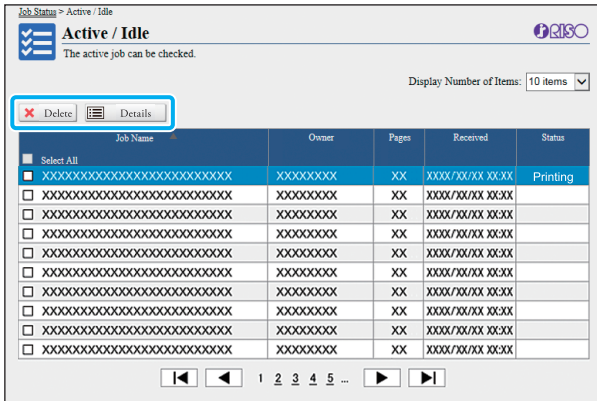

The [Status] item in the title bar of the list shows the status of each job ("Printing", "Suspended", etc.).

[Delete]

Delete the selected jobs.

[Details]

Click this button to view the settings for the selected job. The displayed contents differ depending on the job type.

[Finished] Screen

The [Finished] screen displays finished print jobs, suspended print jobs, and print jobs with errors.

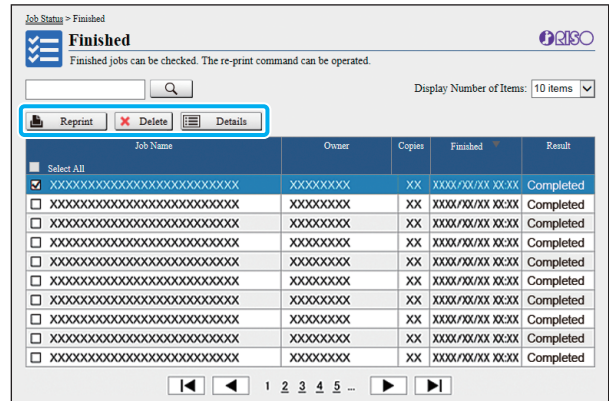

The [Status] item in the title bar of the list shows the result of each job ("Completed", "Error", etc.).

[Reprint]

Click this button to print the selected job again.

[Delete]

Click this button to delete the selected jobs.

[Details]

Click this button to view the settings for the selected job. The displayed contents differ depending on the job type.



- The finished jobs are only displayed when the [Finished Job Setting] on the administrator menu is set to [Save].
- The print function is not available in the following cases.
 - When a job that did not finish properly is selected
 - When a non-print job is selected
 - When printing of a finished job is not permitted
 - When a color job is selected although color printing is not permitted
- The storage period for jobs is configured by the administrator.

[Maintenance] Menu

[Maintenance] Menu Screen

On this screen, you can configure the user-configurable functions of the printer main unit (system).

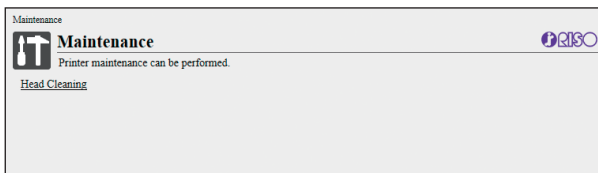

[Head Cleaning]

Clean the print head to prevent clogging. Clean the print head when you notice a change in image quality, such as blurring in part of a printout, white streaking, or faded colors.

When the printer is being used, cleaning of the print head is performed after the printer has finished printing or copying.

1 Press [Head Cleaning].

2 Click [OK].

The screen is displayed to indicate that the settings are sent.

3 Click [OK].

Using the Barcode Area Definition Software

The Barcode Area Definition Software is designed exclusively for use with ComColor FW series products.

The software is used to specify information about the barcode print position, so that highly readable barcodes can be created in documents.

This chapter describes how to install and operate the Barcode Area Definition Software, and how to register a file that defines the barcode position to the printer.

Overview of the Barcode Area Definition Softwarep. 7-2

Installing the Barcode Area Definition Software

Creating and Registering a Barcode Area Definition Filep. 7-5

1. Create a PRN file.



2. Read the PRN file.



3. Specify the barcode area.



4. Save the barcode area definition file.



5. Register the barcode area definition file.





Overview of the Barcode Area Definition Software

Installing the Barcode Area Definition Software

You need to install the Barcode Area Definition Software before using it for the first time.

Operating Environment

The system requirements for activating the Barcode Area Definition Software are described in the table below.

Memory	1 GB or more
CPU	Intel or fully compatible CPU
Hard disk	2 GB or more free space (Space enough to operate the OS)
Display	1024 × 768 or greater resolution

- The operating system that supports the Barcode Area Definition Software is Windows only.

Installing

- Log in as a user with administrator privilege.
- Close all active applications.

- 1 Load the included RISO Printer Driver DVD-ROM in the computer's DVD-ROM drive.**
- 2 Open the [Utility] - [BarcodeAreaDefinitionSoftware] folder on the DVD-ROM, and double-click the "setup.exe" file.**
- 3 Click [Next].**
- 4 Select [I accept the terms in license agreement] and click [Next].**
- 5 Follow the on-screen instructions to configure the settings.**

- When installation is complete, a "Readme" screen is displayed. The "Readme" screen includes precautions for using the machine. Be sure to read this information.

- 6 Remove the DVD-ROM from the computer.**

- Keep the DVD-ROM in a safe place for future reference.

■ **Uninstalling**

- 1** Click [Start] - [Control Panel] - [Programs and Features] - [BarcodeAreaDefinitionSoftware] - [Uninstall].
- 2** Follow the on-screen instructions to uninstall the Barcode Area Definition Software.
- 3** After the Barcode Area Definition Software has been uninstalled, restart the computer.

Starting the Barcode Area Definition Software

- 1** Click [Start] - [All Programs] - [RISO] - [Barcode Area Definition Software].
 - For Windows 8/Windows 8.1, open the "Apps" screen and select [RISO] - [Barcode Area Definition Software].



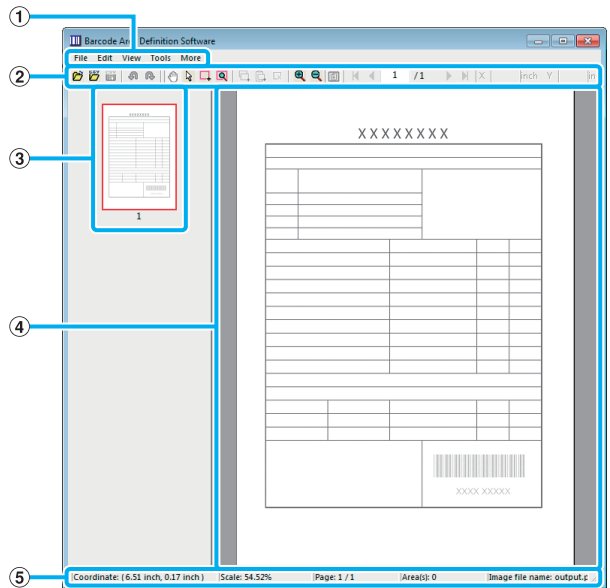





Main Screen









- 1 Menu bar**
The menu bar consists of the [File], [Edit], [View], [Tools] and [More] menus. Each menu includes an edit function and setting items.
- 2 Tool bar**
Various tools are displayed.
- 3 Thumbnail**
A thumbnail of the print image is displayed.
- 4 Image/barcode area display**
The print image is displayed.
- 5 Status bar**
The position (coordinates), magnification, page number and other details are displayed.

Operations

To edit the barcode area, select the print image area and use the functions in the tool bar or menu bar. When the same icon appears in both the tool bar and the menu bar, you can click either one to perform the same operation.

Menu bar	Function
File	
 Open Image File	Opens a selected print file, and display its image.
 Open CSV File	Opens a selected CSV file.
Recreate CSV File	Deletes the barcode area that is displayed.
 Save	Saves the CSV file that you are currently using.
Save As	Saves the currently open file under a new file name.
Page Settings	You can specify the page size of a barcode creation area.
Edit	
 Undo	Cancels the previous edit.
 Redo	Reapplies the previously canceled edit. The 10 most recent edits can be redone.
 Copy	Copies the selected barcode area.
 Paste	Pastes the copied barcode area to another area.
 Delete	Deletes the selected barcode area.
Repetition	You can specify the same barcode area repeatedly. You can specify a cycle of 1 to 999 pages.
View	
Move 	Moves to the first, previous, next, or last page.
Go to	Moves to the specified page. Input the desired page number in the text box, and press the [Enter] key. (This is only displayed in the tool bar.)

Menu bar	Function
Area minor adjustment tool (X/Y/W/H)	Displays the coordinates (X/ Y), width (W), and height (H) of the barcode area in the display unit format (mm/inch). Enter a value in the box to change the barcode area to a specified position or size. (This is only displayed in the tool bar.)
Rotate	Rotates the on-screen print image 90 degrees to the left or right.
Display Units	You can specify mm or inch as the unit to use on the barcode area definition page.
Zoom 	You can specify the magnification ratio for the print image, fit the full image on the page, fit the image to the width of the page, enlarge it, or reduce it.
Thumbnail	Displays or hides the thumbnail.
Status Bar	Displays or hides the status bar.
Tool Bar	Displays or hides the tool bar.
Tools	
 Hand Tool	You can drag a print image to change its display position.
 Selection Tool	You can select a barcode area. Press and hold the Ctrl key to select multiple barcode areas. The selected area is indicated by  .
 Creation Tool	You can specify the barcode area, where the print density is adjusted to make the area suitable for reading. The enclosed area is indicated by  .
 Auto Area Detection	Automatically detects the barcode area on all pages or specified pages.
More	
Version	Displays the version information.

Creating and Registering a Barcode Area Definition File

Output the original data from the printer driver in PRN file format. Open the PRN file using the Barcode Area Definition Software, specify the barcode area, and create a CSV file. The administrator uses the RISO Console to register the barcode area definition file to the printer.

Procedure

● 1 Creating a PRN File

Output the original with printed barcode in PRN file format.

- 1 Click **[Properties]** (or **[Details]**) in the printing dialog box of the application on the computer.
- 2 Click the **[Basic]** tab.
- 3 Select **[Save as a File]** in the **[Output]** pull-down menu.
- 4 Click **[Details]**, and specify a destination.
- 5 Click **[OK]**.
- 6 Click **[Print]**.



- If the optional PostScript kit is installed, select **[Storage]**.

A PRN file is created in the specified destination.

7 If the optional PostScript kit is installed, use the RISO Console to download documents saved in the folder.

Start the RISO Console, select the saved documents on the **[Load]** screen in the **[Storage]** menu, and then click **[Download]**.



- Configure the same settings for the printer driver as when you actually print, except for the **[Output]** setting. If the PRN file format and the actual print setting (original size, print direction, paper size, imposition, etc.) are different, the barcode area definition may not be correctly applied. If you change any settings related to the layout, the coordinates of the area also change.
- PRN files are output by the printer driver in a format that was developed exclusively for RISO KAGAKU CORPORATION. PRN files cannot be opened using printers or applications by other manufacturers.

● 2 Reading the PRN File

Open the PRN file (print image) using the Barcode Area Definition Software.

- 1 Click **[Start]** - **[All Programs]** - **[RISO]** - **[Barcode Area Definition Software]**.
- 2 Click **[File]** - **[Open Image File]**, and select the PRN file.
- 3 Specify the number of pages to read.

Select the **[Detect Barcode Areas Automatically.]** check box to automatically detect the barcode area on all pages.

4 Click [OK].

The print image of the original appears in the image/barcode area.



• If you use mixed-size data, the original data may be oriented differently from the print image. Select [View] in the menu bar, rotate the print image in the same direction as the original data, and specify the barcode area.

• The maximum barcode size that can be read by [Detect Barcode Areas Automatically.] is 100 mm (W) × 30 mm (H) (3 15/16" × 1 3/16"), and the minimum size is 20 mm (W) × 5 mm (H) (25/32" × 7/32").



- The barcode area may not be detected automatically in the following cases:
 - When the space between barcodes is 5 mm (7/32") or less
 - When the barcode image is not clear
 - When the barcode is placed at an angle, or when the black bars are not straight
 - When the bars are not true black (RGB 0.0.0)
 - When the space between the bars is not true white (RGB 255.255.255)

3 Specifying the Barcode Area

Use to surround the barcode on the screen.

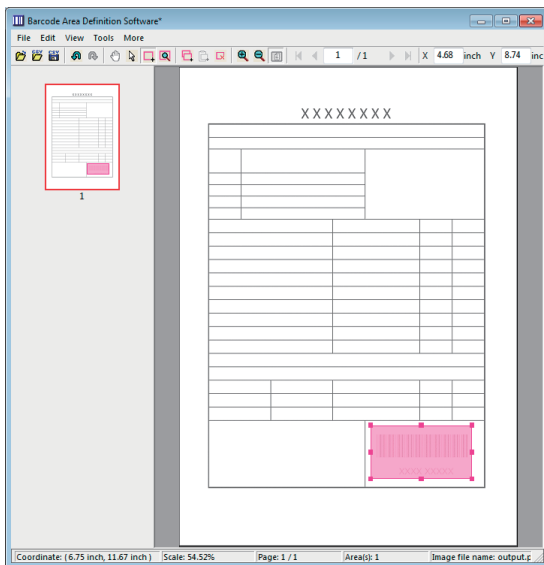

The enclosed area is colored and specified as the barcode area.

To edit the barcode area, use the edit tool and menu bar. (p. 7-4 "Operations")

If automatic barcode area detection was used, make sure that the barcode was detected properly. If the detected area is not aligned with the barcode, use (selection tool) to adjust the position.

Thumbnail Display

The top left corner of a thumbnail image is the base point, and the original image and barcode area definition image are displayed overlapping each other. If the original image and barcode area definition image are not the same size, a thumbnail like the one shown below is displayed. To specify a barcode area in the portion that is grayed out, align the original image and barcode area definition image in the same direction.

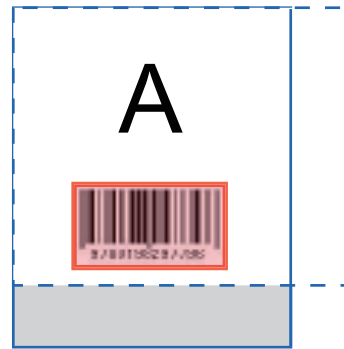

In this example, the original image (solid line) is smaller than the barcode area definition image (dotted line). The portion outside the barcode area definition image is grayed out.



- You can specify up to 50 barcodes per page on as many as 30 pages. If you specify [Repetition], you can apply areas repeatedly.
- Barcode areas can be moved on the same page using (selection tool). To move barcode areas to a different page, copy and paste them to the desired page. You cannot paste the copied barcode area if it is larger than the original.

■ Precautions Regarding Barcode Area Definition

If the position information of the specified barcode area changes, such as when an image is rotated, the barcode area is not processed properly.

If the image is rotated or the print direction is changed, use the creation tool to specify the barcode area again. (Correct the barcode area starting from the base point.)

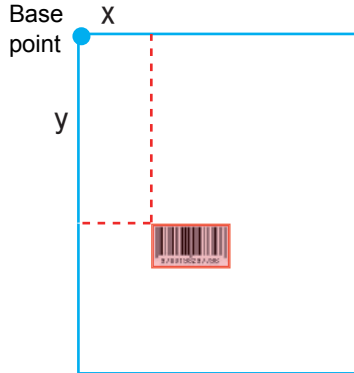

Example of when barcode processing is performed correctly

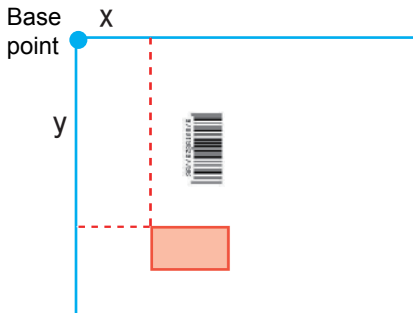

Example of when barcode processing is not performed correctly, because the original is rotated and the position of the barcode relative to the base point is changed

● 4 Saving the Barcode Area Definition File

Click  in the menu bar. The barcode area definition file is output (saved) in CSV format. To change the file name when saving, select [Save As] in the [File] menu.



- The CSV file specifies the size (W, H) and position coordinates (X, Y) of the barcode on a printout (in 0.1 mm (0.004") units) relative to the base point, which is the top left corner of the original data created on a computer.

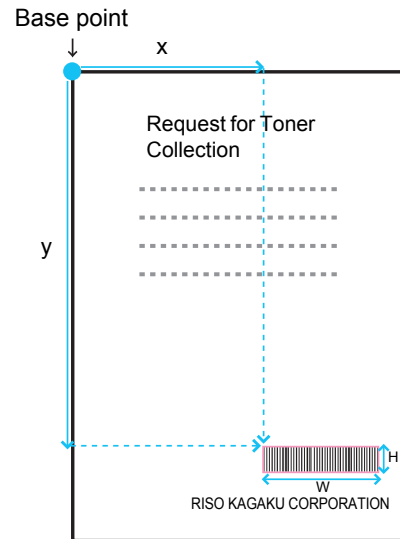

● 5 Registering the Barcode Area Definition File











































Register the barcode area definition file to the printer in the administrator menu on the RISO Console. For more information, see the separately provided "Administrator's Guide".

Repetition Function

If you use the [Repetition] function when specifying the barcode areas, the areas are specified repeatedly for subsequent pages based on the value specified for [Cycle] in the [Repetition] dialog box. This eliminates the need to define the area on each and every page.

- When cycle is 0: The barcode areas are applied only on the pages that are configured in the barcode area definition file.
- When cycle is 1: The barcode areas configured for the first page in the barcode area definition file are repeated on each page until the last one.
- When cycle is 2: The barcode areas configured for the first 2 pages in the barcode area definition file are repeated on every 2 pages until the last one.
- When cycle is 3: The barcode areas configured for the first 3 pages in the barcode area definition file are repeated on every 3 pages until the last one.

The example below shows when barcode areas are defined for 3 pages.

Original data	            
Barcode area definition	  
Cycle: 0	             <p>The pages that you configure in a barcode area definition file Barcode processing is not configured for pages 4 to 13.</p>
Cycle: 3	             <p>The pages that you configure in a barcode area definition file Repeated pages Repeated pages Repeated pages</p>



- You can specify from 1 to 999 pages for [Cycle].
- The pages after the ones set in the repetition process do not appear in the thumbnails.

Printing Barcode Originals

You can select a registered barcode area definition file from the [Barcode Area Definition] pull-down menu in the [Image] tab on the printer driver screen.

Select a suitable barcode area definition file when printing a barcode original. (p. 3-22 "Barcode Area Definition")

Optional Equipment

This chapter describes the optional equipment that can be used with this machine.

Face Down Finisher p. 8-2

This section describes the settings and functions that are available when the face down finisher is connected.

Stacking Tray (Auto-control Stacking Tray / Wide Stacking Tray)..... p. 8-8

This section describes the settings and functions that are available when the auto-control stacking tray/wide stacking tray is connected.

PostScript Kit p. 8-12

This section describes the settings and functions that are available when the PostScript kit is installed.

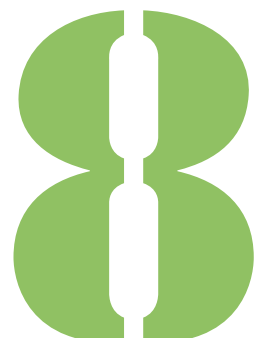

Face Down Finisher

If the optional face down finisher is connected, you can staple printed sheets, or perform offset output for each set of printed documents.

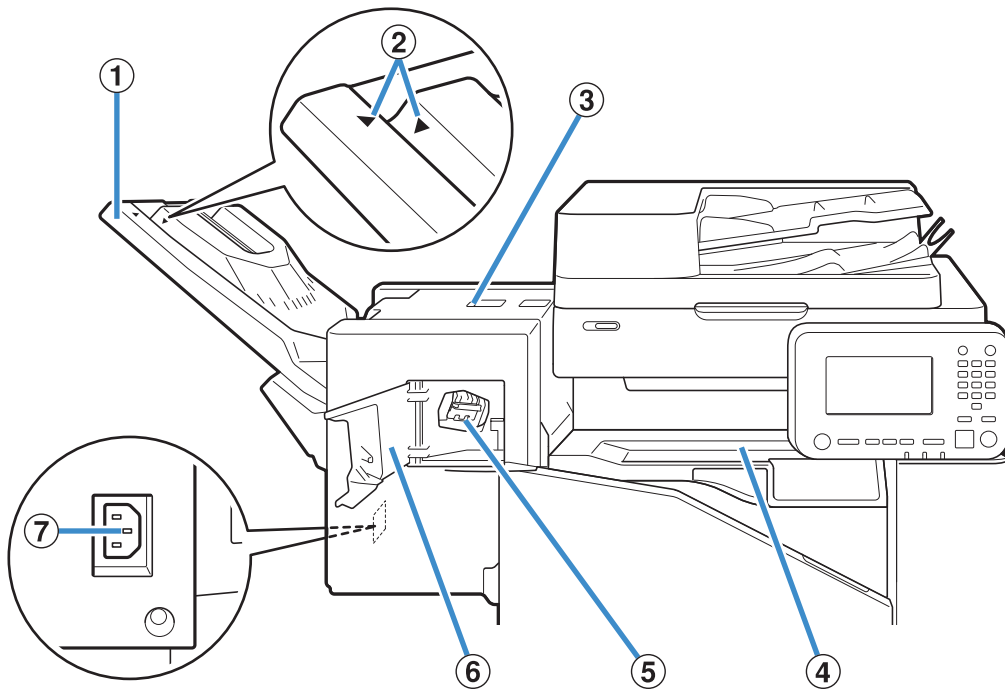

① Stacking Tray

Printouts are output face down.

② Stacking Tray Setting Position

Slide into position depending on the paper type or output condition.

③ Jam Release Cover

④ Top Cover

If a paper jam occurs during paper transfer from the printer to the face down finisher, open this cover and remove the jammed sheet.

⑤ Staple Cartridge

Pull out the staple cartridge to replace staples, or if a staple is jammed.

⑥ Staple Cover

Open this cover if a staple is jammed, or to replace the staple cartridge.

⑦ Face Down Finisher Socket

Connect the face down finisher power cord.



- The stacking tray slides. For normal output, align the ► and ◀ shown in ②.

Normal (except for the case shown on the right)	When using B5 or smaller paper without staples
<p>Align ► and ◀.</p>	<p>Position ► and ◀ apart from each other.</p>

List of Settings

The items described below can be set when the face down finisher is connected.

Printer Driver

Setting item	Description	See
[Finishing] tab		
Offset Output	You can stack each set of printed documents slightly apart from one another when printing multiple copies.	p. 8-3
Staple	Select the stapling position.	p. 8-4
[Advanced] tab		
Program	Specify this when the number of required copies varies by group (such as corporate division or class).	p. 3-25
Offset Output (Program)	You can stack each set of printed documents slightly apart from one another to create separation.	p. 8-6



- When [Staple] is grayed out in the [Finishing] tab, make sure that [Printer Configuration] in the [Environment] tab on the properties screen has been configured correctly. (p. 3-26 "Printer Configuration")

Copy Mode

Setting item	Description	See
Program	Specify this when the number of required copies varies by group (such as corporate division or class).	p. 1-18
Offset Output ([Program])	You can stack each set of printed documents slightly apart from one another to create separation.	p. 8-7
Separation	Specify where to insert slip sheets between printouts.	p. 1-21
Offset Output ([Separation])	You can stack each set of printed documents slightly apart from one another to create separation.	p. 8-6
Staple	Configure the staple settings.	p. 8-6

Printer Driver Settings

Offset Output

Stack each set of printed documents slightly apart from one another when printing multiple copies.



- When [Program] is configured, [Offset Output] is [OFF]. (p. 3-25 "Program")
 - This setting is not available for paper sizes that cannot be output to the face down finisher.
 - When using the face down finisher, you cannot use this setting with stapling.
 - When [Mixed Size Original] is configured, [Offset Output] is [OFF]. (p. 3-11 "Mixed Size Original")

[OFF]

Offset output is not performed.

[Between Sorts]

Each set of printed documents specified in [Sort] is stacked slightly apart from one another.

[Between Jobs]

Each finished print job is stacked slightly apart from one another.

Staple

Select the stapling position.



- When [Staple] is configured, make sure to configure [Binding Edge].
- When [Staple] is configured, [Sort] is set to [Collated]. (p. 3-10 "Sort")
- When [Mixed Size Original] is configured, [Staple] is [OFF]. (p. 3-11 "Mixed Size Original")
- When [Booklet] is configured, [Staple] is [OFF]. (p. 3-16 "Booklet")
- The orientation of the paper varies depending on the binding edge. See "Staple Function and Loading Orientation of the Paper" (p. 8-5).

If you select [Left] or [Right] for [Binding Edge], select from the following options.

[OFF], [1 Staple], [2 Staples]

If you select [Top] for [Binding Edge], select from the following options.

[OFF], [Left 1 Staple], [Right 1 Staple], [2 Staples]

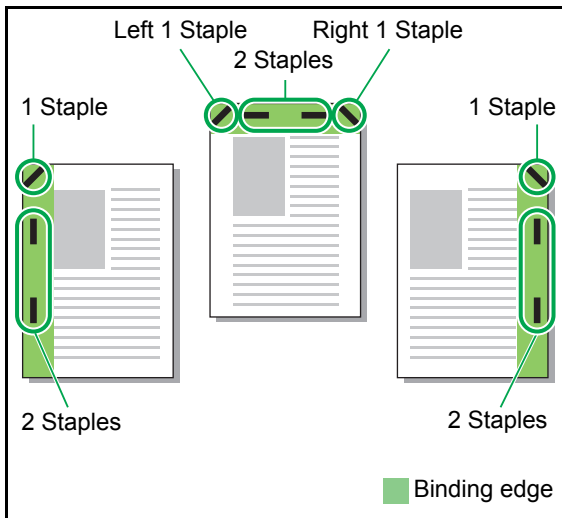

<Types of paper that can be stapled>

- Paper size: A3, B4, A4, A4-LEF^{*1}, B5, B5-LEF, Ledger, Legal, Letter, Letter-LEF, Foolscap

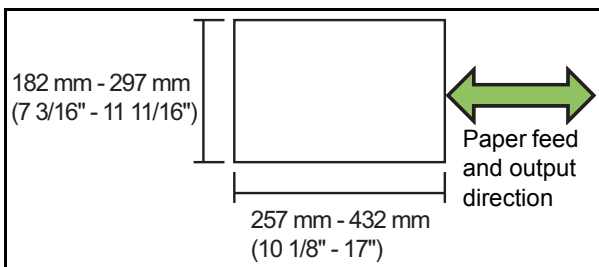

- Paper weight: 52 g/m² to 210 g/m²

<Number of sheets that can be stapled>

- Standard size paper
A4, A4-LEF, B5, B5-LEF (Letter, Letter-LEF): 2 - 50 sheets^{*2}
Sizes other than the above (A3, B4 (Ledger, Legal, Foolscap)): 2 - 25 sheets^{*2}
- *1 Long Edge Feed
- *2 When using plain paper and recycled paper (85 g/m² (23-lb bond))



- Stapling cannot be performed when using irregular-sized paper.
- When the printing job exceeds the maximum number of sheets that can be stapled, a confirmation screen is displayed so that you can select whether to stop printing or continue printing without stapling.

Features of the Face Down Finisher

The size of the paper that can be stapled varies depending on the model.

	ComColor FW 5000/5000R	ComColor FW 5230/5230R 5231/5231R
	✓	✓
	✓	✓
	N/A	✓
	N/A	✓
	N/A	✓
	N/A	✓
	✓	✓
	N/A	✓
	N/A	✓



- Paper sizes in inches are as follows:
A3 (Ledger) A4 (Letter) B4 (Legal)

Staple Function and Loading Orientation of the Paper

The orientation of the paper in the paper tray and the staple binding edge are shown below.

Orientation: Portrait

Orientation: Landscape

Face up data

Face down data

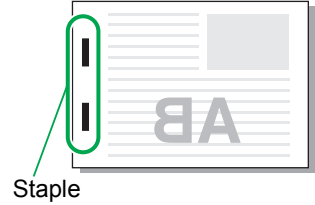
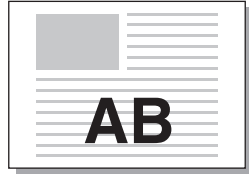
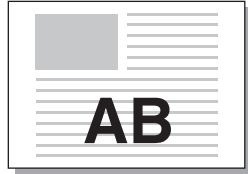
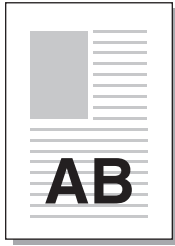

Binding edge	Staple position							
	1 Staple		2 Staples					
Left					/			
Right								
Top	Left 1 Staple		Right 1 Staple				2 Staples	
Paper transfer								

- When the corresponding size of paper is not loaded in the paper tray, a message is displayed. Follow the on-screen instructions to load the paper.
- For [1 Staple] binding, the staple angle may differ from the images above and the print images on the printer driver screen, depending on the paper size or orientation.

Offset Output (Program)

When [Program] is used, each set of printed documents is stacked slightly apart from one another to create separation. For more information on configuring [Program], see "Program" (p. 3-25) in "Print".

[OFF]

Offset output is not performed.

[Between Sets]

Each set of printed documents is stacked slightly apart from one another.

[Between Groups]

Each group of printed documents is stacked slightly apart from one another.

Copy Mode Settings

Offset Output ([Separation])

When [Separation] is used, each set of printed documents is stacked slightly apart from one another to create separation.

[OFF]

Offset output is not performed.

[Between Sorts]

Each sorted set is stacked slightly apart from one another.

[After a Job]

Each print job is stacked slightly apart from one another.

<Paper that can be offset>

- When using the face down finisher:
131 mm × 148 mm - 305 mm × 550 mm (5 3/16" × 5 27/32" - 12" × 21 5/8")

- 1 Touch [Separation].
- 2 Select the offset output setting.
- 3 Touch [OK].

Staple

Staple at the specified position.

<Types of paper that can be stapled>

- Paper size: A3, B4, A4, A4-LEF^{*1}, B5, B5-LEF, Ledger, Legal, Letter, Letter-LEF, Foolscap

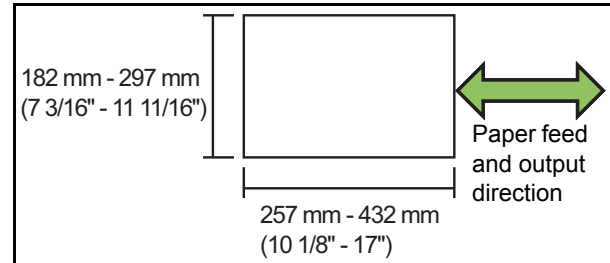

- Paper weight: 52 g/m² to 210 g/m²

<Number of sheets that can be stapled>

- Standard size paper
A4, A4-LEF, B5, B5-LEF, (Letter, Letter-LEF):
2 - 50 sheets^{*2}
Sizes other than the above (A3, B4 (Ledger, Legal, Foolscap)): 2 - 25 sheets^{*2}
^{*1} Long Edge Feed
^{*2} When using plain paper and recycled paper
(85 g/m² (23- lb bond))



- When the printing job exceeds the maximum number of sheets that can be stapled, a confirmation screen is displayed so that you can select whether to stop printing or continue printing without stapling.
- Stapling cannot be performed when using irregular-sized paper.
- The size of the paper that can be stapled varies depending on the model. (p. 8-4 "Features of the Face Down Finisher")

Original Orientation

[Top Side Up]

Select this option when loading originals in an orientation from which they can be read normally.

[Top Side Left]

Select this option when loading originals so that the top of the original is aligned with the left edge.

Binding Edge

Select the binding edge of the paper.

Left, Right, Top

■ Staple

Select the stapling position.

If you select the left or the right for [Binding Edge], select from the following options.

[OFF], 1 staple, 2 staples

If you select the top for [Binding Edge], select from the following options.

[OFF], left 1 staple, right 1 staple, 2 staples



- The left 1 staple and the right 1 staple are displayed only when the top is selected for [Binding Edge].

- 1 Touch [Staple].
- 2 Select the original orientation.
- 3 Configure [Binding Edge].
- 4 Configure [Staple].
- 5 Touch [OK].

■ Binding Margin

You can specify the binding margin so that staples are not in the printing area.

- 1 Touch [Binding Margin] on the [Staple] screen.

The [Binding Margin] screen is displayed.

- 2 Specify the binding margin.

- Select [Binding Edge].
- Use [↓], [↑], or the numeric keys to enter the width.
- If part of the printing area is missing due to the binding margin setting, set [Auto Reduction] to [ON].

- 3 Touch [OK].

Offset Output ([Program])

When [Program] is used, each set of printed documents is stacked slightly apart from one another to create separation.

For more information on the program, see "Program" (p. 1-18) in "Copy".

[OFF]

Offset output is not performed.

[Between Sets]

Each set of printed documents is stacked slightly apart from one another.

[Between Groups]

Each group of printed documents is stacked slightly apart from one another.

Stacking Tray (Auto-control Stacking Tray / Wide Stacking Tray)

The auto-control stacking tray and wide stacking tray are available as optional stacking trays.

- With the auto-control stacking tray, the paper guides adjust automatically to fit the paper size.
- With the wide stacking tray, move the paper guides (side and end) to match the paper size.

<The auto-control stacking tray is shown in this illustration.>

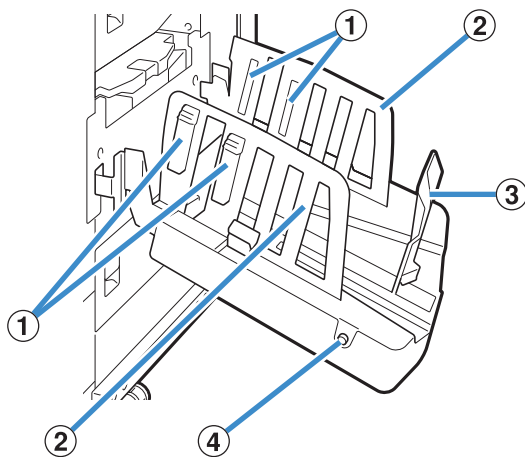

① Paper Arrangers

Set to suit the paper type so that the output paper is neatly aligned.

② Paper Guides (side)

③ Paper Guide (end)

Use to prevent output paper in the stacking tray from becoming misaligned.

④ Paper Guides Open Button

(Auto-control stacking tray only)

Use to spread the paper guides apart. Operation varies depending on whether paper is present or not.

- When the machine is idle and there is no paper in the stacking tray, the guides open to the loading position.
- When the machine is idle and there is paper in the stacking tray, the paper guides spread apart, making it easy to remove the paper. The administrator can configure which paper guides spread apart when the button is pressed.

Loading the Stacking Tray

Follow the procedure below to load the stacking tray. Depending on the paper size or type, you can also adjust the paper arranger at this time.



• The auto-control stacking tray is shown in the illustrations below.

- When using the wide stacking tray, manually adjust the positions of the paper guides (side and end) to match the paper size.

1 Open the stacking tray in the direction of the arrow until it stops.

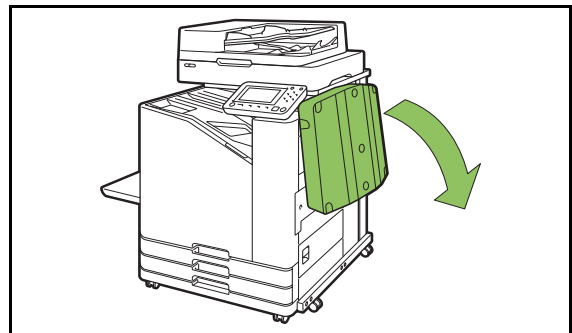

2 Lift the paper guides (side) to stand them upright.

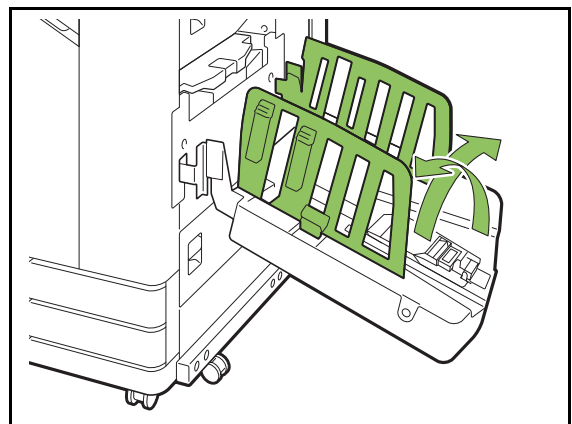

3 Adjust the paper arranger.

Normally, the paper arranger should be extended when printing on paper that is B4 size or smaller. How paper is stacked after printing varies depending on stiffness and other factors. Adjust the paper arranger as needed.

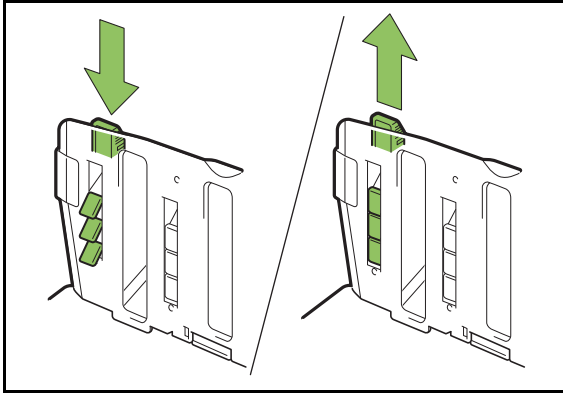

4 Lift the paper guide (end) to stand it upright.

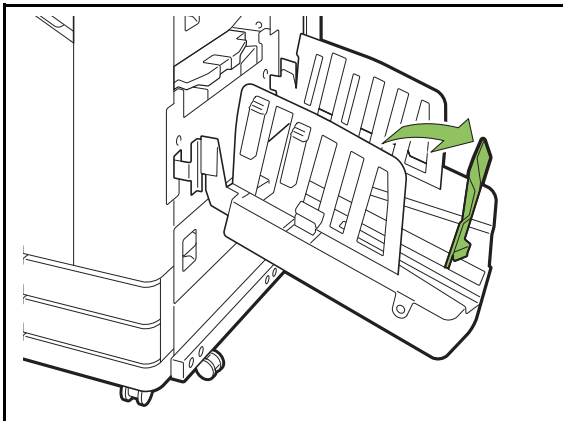

• Fold all paper guides when printing on paper larger than 320 mm × 432 mm (12 1/2" × 17").

Closing the Stacking Tray

1 After confirming that there are no printouts in the stacking tray, press the paper guides open button.

The paper guides (side and end) now move into position for storage.

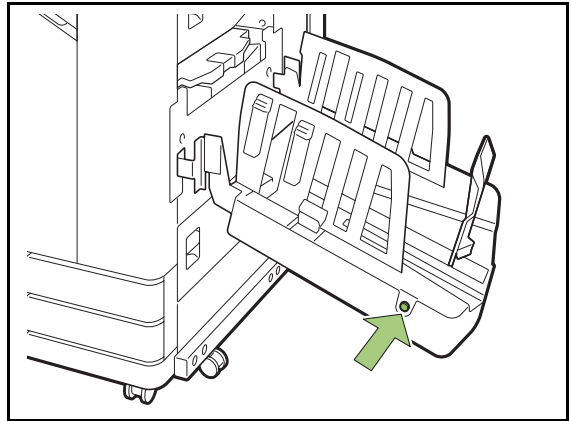

2 Lower the paper guide (end) toward the stacking tray to fold it up.

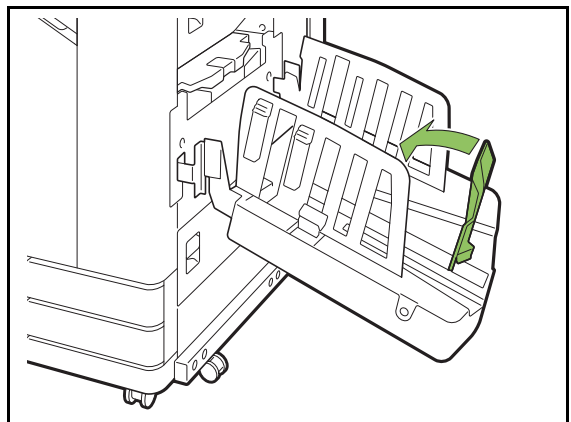

3 Fold up the paper arranger.

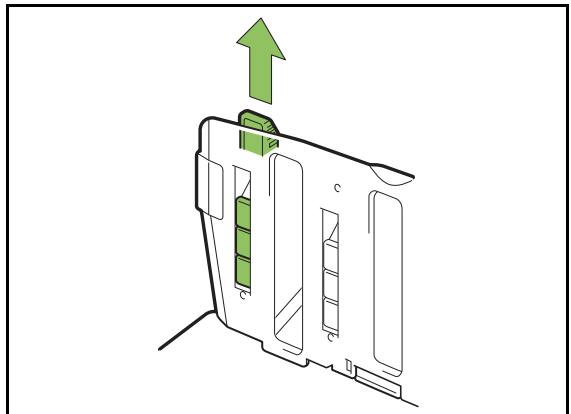

- 4** Lower the paper guides (side) inward, and then close the stacking tray.

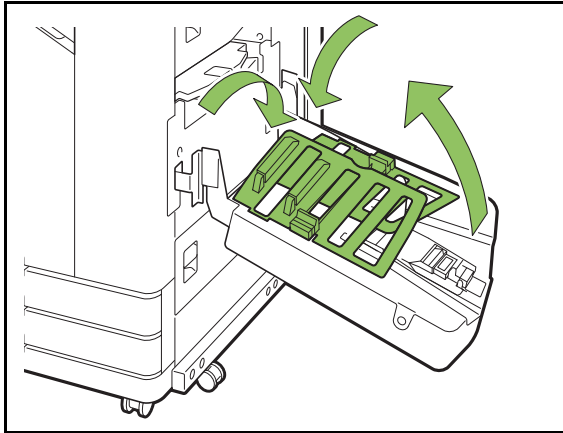

List of Settings

The items described below can be set when the stacking tray is connected.

Printer Driver

Setting item	Description	See
[Finishing] tab		
Output Tray	Specify the output tray.	p. 8-11
Output Tray Relay	Select this to switch the output tray automatically when the tray is full.	p. 8-11

Copy Mode

Setting item	Description	See
Output Tray	Specify the output tray.	p. 8-11
Output Tray Relay	Select this to switch the output tray automatically when the tray is full.	p. 8-11

Maintenance Mode

Setting item	Description	See
Paper Guide Control	Adjust the position of the paper guides of the auto-control stacking tray.	p. 8-11

Printer Driver Settings

Output Tray

Specify the output tray for printouts. When [Auto] is specified, printouts are output to the appropriate tray automatically based on the configured functions. If the stacking tray is connected, select [Auto-control Stacking Tray] or [Wide Stacking Tray].

Output Tray Relay

The output tray switches automatically when the tray is full. You must set [Output Tray] to [Auto] in the [Finishing] tab, and set [Sort] to [Uncollated] in the [Basic] tab.

-  This setting is not available when using the wide stacking tray.

Copy Mode Settings

Output Tray

Select the output tray for printouts.

-  The tray details displayed on the [Output Tray] screen vary depending on the optional equipment that is connected.

[Auto]

The appropriate tray is selected automatically. When [Output Tray Relay] is set to [ON], select [Auto].

[① Face Down Tray], [② Wide Stacking Tray]

Select the output tray.

- 1 Touch [Output Tray].
- 2 Select the output tray.
- 3 Touch [OK].

Output Tray Relay

The output tray switches automatically when the tray that is being used becomes full.

- 1 Touch [Output Tray Relay].
- 2 Touch [ON].
- 3 Touch [OK].



- This setting is not available when using the wide stacking tray.

- When [Output Tray Relay] is configured, [Sort] is set to [Uncollated]. (p. 1-10 "Sort")

Maintenance Mode Settings

Paper Guide Control

Adjust the position of the paper guides of the auto-control stacking tray. For more information, see the separately provided "Troubleshooting Guide".

PostScript Kit

This is a dedicated printer driver that supports PostScript 3. This section describes basic printer driver operations, as well as how to use various functions.



- Log in as a user with administrator privilege (Windows), or as a root user (OS X or Linux).
- Close all active applications.

Operating Environment

The system requirements for activating the PostScript 3 printer driver are described in the table below.

Memory	1 GB or more
CPU	Windows or Linux: Intel or fully compatible CPU OS X: Intel CPU
Hard disk	2 GB or more free space (Space enough to operate the OS)
Display	1024 × 768 or greater resolution

Installing to Windows

1 Load the included DVD-ROM in the computer's DVD-ROM drive.

The installation wizard automatically starts up. If the installation wizard does not start up, double-click the "Install.exe" file on the DVD-ROM.

2 Select the desired language in the pull-down menu and click [OK].

3 Follow the on-screen instructions to configure the settings.

4 Click [Finish].

If the printer driver is installed over the existing one, the computer restarts.



- If you do not want to restart the computer now, remove the check mark from the [Restart now] check box before clicking [Finish].

5 Remove the DVD-ROM from the computer.



- Keep the DVD-ROM in a safe place for future reference.

Uninstalling From Windows

Use the uninstaller to uninstall the printer driver compatible with PostScript 3.

Uninstall the printer driver in the same way as described in "Uninstalling the Printer Driver" in the separately provided "Administrator's Guide".

Installing to OS X

1 Load the included DVD-ROM in the computer's DVD-ROM drive.

Double-click the installation package file on the DVD-ROM.

2 Select the desired language in the pull-down menu and click [OK].

3 Click [Next].

4 Click [Agree].

5 Follow the on-screen instructions to configure the settings.

On the authentication screen, enter values for [Name] and [Password], and click [OK].



- Contact your administrator for [Name] and [Password] information.

6 Click [Finish].

7 Remove the DVD-ROM from the computer.



- Keep the DVD-ROM in a safe place for future reference.

8 Add a printer.

- 1 Open the Mac OS X startup volume, and open [Applications] - [System Preferences].
- 2 Click [Print & Scan] or [Printers & Scanners].
- 3 Click the [+] button.

9 Configure the queue.

On the [Add] screen, click [IP] and enter the IP address and queue.

Queue: Enter "lp" in lower case characters for the queue.

Uninstalling From OS X

1 Open the Mac OS X startup volume, and open [Applications] - [System Preferences].

2 Click [Print & Scan] or [Printers & Scanners].

3 Select the printer you want to delete, and click the [-] button.



- Delete the following folder and file from the Mac OS X startup volume as needed.
 - The [RISO] folder in [Library] - [Printers].
 - The "RSFW****.ppd" file in [Library] - [Printers] - [PPDs] - [Contents] - [Resources].

Installing to Linux

Printing can be performed from Linux if the PPD file included on the DVD-ROM is registered to CUPS for Linux.



- Before installing, make sure that all of the necessary Linux system settings are properly configured.
- The procedure for installing to Linux may vary depending on your Linux environment. The standard installation procedure is described here.

1 Open the screen for registering a printer.

2 Configure the printer.

Follow the on-screen instructions to select the protocol (LPD, LPR, etc.), and enter the IP address of the printer.

3 Configure the queue.

Enter "lp" in single-byte lower case characters for the queue.

4 Select the driver.

Load the included DVD-ROM in the computer's DVD-ROM drive, and select the PPD file.

5 Follow the on-screen instructions to configure the settings.

Enter the printer name and other required information.

6 Remove the DVD-ROM from the computer.



- Keep the DVD-ROM in a safe place for future reference.

Uninstalling the PPD File

1 Open the screen for registering a printer.

2 Select the printer icon and delete it.

How to Print

Printing from a Windows Computer

For more information, see "Overview of Print Operations" (p. 3-2) in "Print".

Printing from a Mac

This section describes the basic procedure for printing from a Mac.



- The screens displayed may vary depending on the operating system and applications used, as well as the optional equipment connected.
- Some setting items may not be displayed, depending on how the administrator has configured the settings. Contact your administrator for details.

1 Open the print screen in the application on the computer.

Select [Print] in the [File] menu.

2 Select the printer.

3 Click [▼].

4 Click [Details].

Change the settings and click [OK].

5 Click [Print] to perform printing.

Printer Driver Settings

This section describes the items that can be configured when the PostScript kit is installed, using the [Print Setting] screen in Windows as an example.

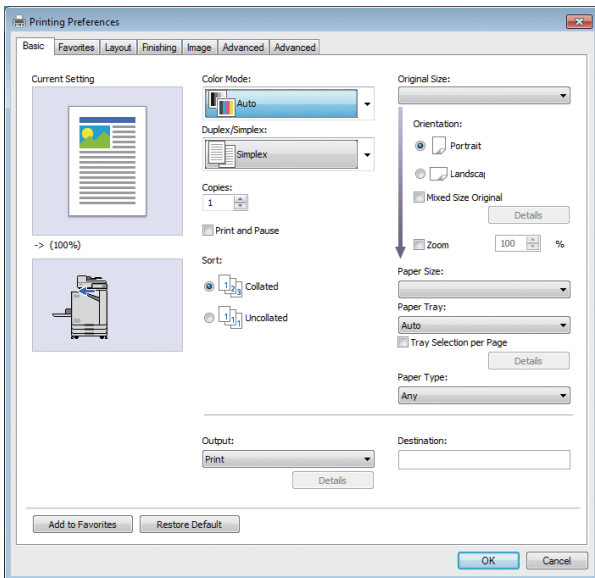

- When optional equipment is connected, first configure the settings in [Printer Configuration] under the [Environment] tab to use certain functions.
- When printing from a Mac, use the standard OS settings for [Copies], [Original Size], and [Orientation].

[Basic] Tab

For more information on each setting item, see "[Basic] Tab" (p. 3-9) in "Print".

Output

Specify whether to print the data sent from a computer, or save it in a folder on this machine. Form data can also be registered to the machine.

[Print]

Prints the data.

[Print & Storage]

Prints the original data and save it in a folder on the machine.

[Storage]

Saves the original data in a folder on the machine. In addition, create a PRN file to use in the Barcode Area Definition Software.

[Form]

Registers forms.

For more information, see "Form Overlay" (p. 8-18) in the [Advanced] tab.

Tray Selection Per Page

You can specify the tray to use for each page. When the check box is selected, you can specify which tray to print from, for each page.

[Standard Tray]

Specify the pages that are printed from the standard tray.

[Feed Tray 1]

Specify the pages that are printed from feed tray 1.

[Feed Tray 2]

Specify the pages that are printed from feed tray 2.



- Use commas to separate the specified page numbers (1,2,3, etc.), or specify a range of pages (such as 1-10).
- If no tray is specified for a particular page, it is printed from the tray specified in the [Paper Tray] setting.
- When a tray is specified for a page, image processing is performed on the page based on the paper settings (paper type) for the specified tray.

■ Setting Example

Specifying a tray for each page when printing a 15-page document

Tray to use	Setting values
Standard tray	1,5
Feed tray 1	6-10
Feed tray 2	11-13,15

Pages 1 and 5 are printed from the standard tray, pages 6 through 10 are printed from feed tray 1, and pages 11 through 13, along with page 15, are printed from feed tray 2. Pages 2 through 4, along with page 14, none of which have a specified tray, are printed from the tray specified in the [Paper Tray] setting.



- The [Tray Selection per Page] function cannot be used in combination with [Imposition], [Booklet Binding], [Offset Output], [Mixed Size Original], [Select Front Cover Tray], or [Select Back Cover Tray].

[Favorites] Tab

For more information on each setting item, see "[Favorites] Tab" (p. 3-14) in "Print".

[Layout] Tab

For more information on each setting item, see "[Layout] Tab" (p. 3-15) in "Print".



- The [Watermark] setting is not available with the PostScript printer driver.

Image Shift

Adjust the printing position of images.



- You can adjust the printing position a maximum of ± 254 mm (10") up, down, left, or right, in increments of 0.1 mm (0.004").
- When performing duplex printing, the front and back sides can be adjusted separately.

Select the [Image Shift] check box and click [Details] to display the [Image Shift] dialog box. Enter a value in the box for the direction that you want to adjust.

[Front Side], [Back Side]

Enter a value for [Horizontal] or [Vertical].

[Reset]

Resets the entered value to 0 on the front or back side separately.

Preview

You can preview the adjusted image position on the front or back side separately.

[Finishing] Tab

For more information on each setting item, see "[Finishing] Tab" (p. 3-19) in "Print".



- For more information on [Staple] and [Offset Output], see "Face Down Finisher" (p. 8-2).
- For more information on [Output Tray] and [Output Tray Relay], see "Stacking Tray (Auto-control Stacking Tray / Wide Stacking Tray)" (p. 8-8).

[Image] Tab

For more information on each setting item, see "[Image] Tab" (p. 3-21) in "Print".



- In the [Image Quality] setting, [Data Compression (300 × 300 dpi)] is not available with the PostScript printer driver.

Gamma Correction

Corrects the brightness, contrast, and gamma value of CMYK.

Select the [Gamma Correction] check box and click [Details] to display the [Gamma Correction] dialog box.

[Brightness]

The smaller the value, the brighter (more whitish) the color. The larger the value, the darker (more blackish) the color.

Specify a value between -2 and +2.

[Contrast]

Adjusts the ratio of brightness to darkness. The smaller the value, the lower the contrast. The larger the value, the higher the contrast.

Specify a value between -2 and +2.

[Cyan], [Magenta], [Yellow], [Black]

Corrects the gamma value of each color.

The smaller the value, the lighter the color. The larger the value, the deeper the color. When you set the value to 1.00, the gamma value is not corrected and the color does not change.

Specify a value between 0.01 and 3.00.



- Make your color adjustments based on the advice of the administrator.

Color Profile

Use a color profile to perform color management. When the check box is selected, [Details] is displayed.

■ Output Profile

You can select [Auto] or any output profile that has been added.



- When [Auto] is selected, the output profile is automatically configured based on the paper type and resolution settings.

■ Rendering Intent

Use a color conversion method to perform color replacement when different colors are expressed by combinations of numerical values.

Select one of four different color conversion methods to perform color replacement.

[Perceptual]

Preserves the visual relationship between colors, so that colors that appear natural to the human eye.

- This method is useful when the image data includes many out-of-gamut colors that cannot be printed, and is most suitable for photographic images.

[Saturation]

Produces vivid colors in the image.

- This method is most suitable for graphics such as charts and graphs, in which bright saturated colors are important.

[Relative Colorimetric]

Compares the extreme highlights of the source color space to that of the destination color space, and converts all colors accordingly. Out-of-gamut colors are converted to the closest reproducible color in the destination color space.

- This method preserves more of the original colors in an image than [Perceptual].

[Absolute Colorimetric]

Preserves the colors that are inside the gamut, and clips those that are outside the gamut.

- This method is particularly useful for previewing how paper color affects printed colors.

■ Max Drops

You can manually set the maximum number of drops for the ink.



- When [Max Drops] is set to [Auto], the number of drops is automatically configured based on the paper type. Normally, use [Auto].

[Advanced] Tab

For more information on each setting item, see "[Advanced] Tab" (p. 3-24) in "Print".

- The [Program] and [Blank Page Detection] settings are not available with the PostScript printer driver.
- [Color Profile] is not displayed on the [Version] screen of the PostScript printer driver.

Form Overlay

You can select a form that has been registered to the machine, and overlay it on the output data for printing.

Select the [Form Overlay] check box and click [Details] to display the [Form Overlay] dialog box. Configure the settings for overlaying the form.

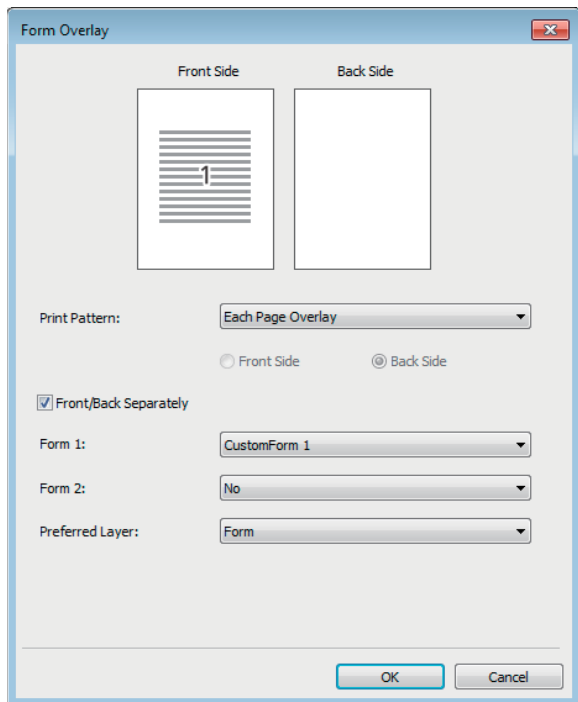
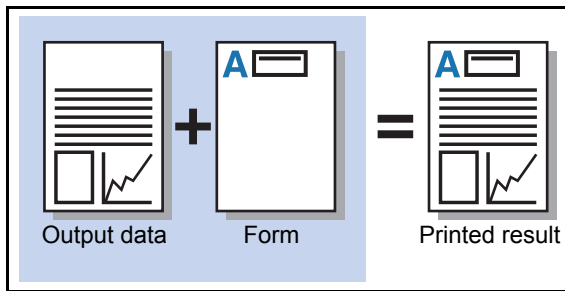

[Print Pattern]

Specify whether to print the form on the same side as the output data.

[Print Face]

When [Alternating Overlay (Long Edge)]/[Alternating Overlay (Short Edge)] or [Each Page + Alternating Overlay (Long Edge)]/[Each Page + Alternating Overlay (Short Edge)] is selected, specify whether to print the form on the front or back.

[Front/Back Separately]

When performing duplex printing, you can specify separate forms for the front and back.

- This setting is available if [Each Page Overlay] or [Each Page + Alternating Overlay (Long Edge)]/[Each Page + Alternating Overlay (Short Edge)] is selected in [Print Pattern].

[Form 1]

Select the form to print on the front or both sides of the output data.

[Form 2]

Select the form to print on the back side of the output data.

[Preferred Layer]

When [Each Page Overlay], [Each Page + Alternating Overlay (Long Edge)], or [Each Page + Alternating Overlay (Short Edge)] is selected, specify whether to assign priority to the form or the output data.

- Before using these settings, you must first create the form data on a computer and register it in [Output] in the [Basic] tab. (p. 8-15 "Output")
- Forms are printed based on the output data orientation, paper size, and image quality settings.
- Output data with overlaid forms cannot be saved (registered).

■ Print Pattern

Select a form that is saved on the machine, and select which side of the paper to print it on.

[Each Page Overlay]

Prints the form on the same side as the output data. When performing duplex printing, select [Front/Back Separately]. When the [Front/Back Separately] check box is selected, you can select forms for [Form 1] and [Form 2] from the form list.

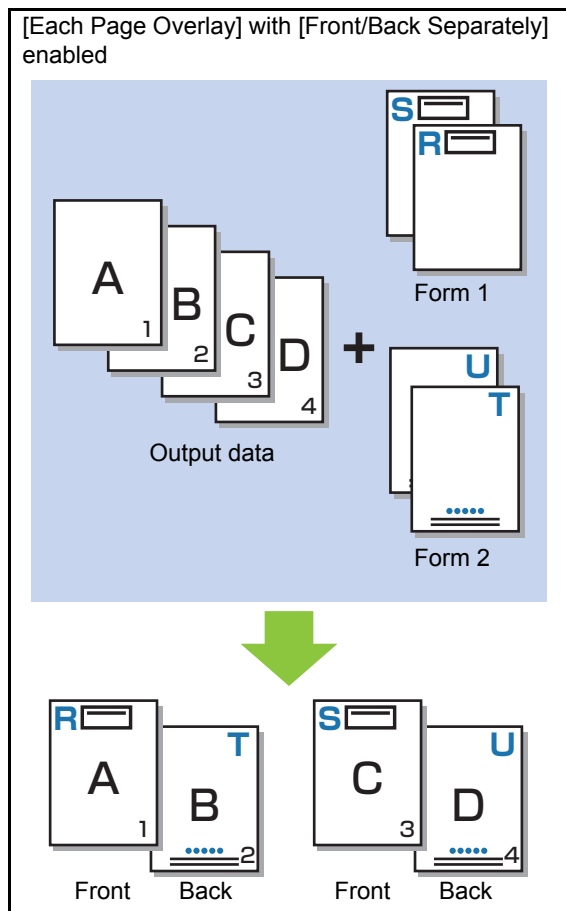
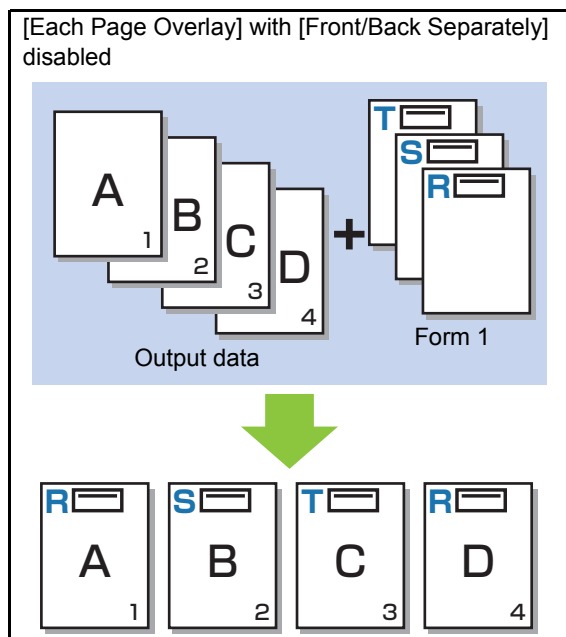

[Alternating Overlay (Long Edge)]/[Alternating Overlay (Short Edge)]

Prints the form and output data on different sides. The form data is printed on the side specified in [Print Face]. The output data is printed as variable data on the other side.

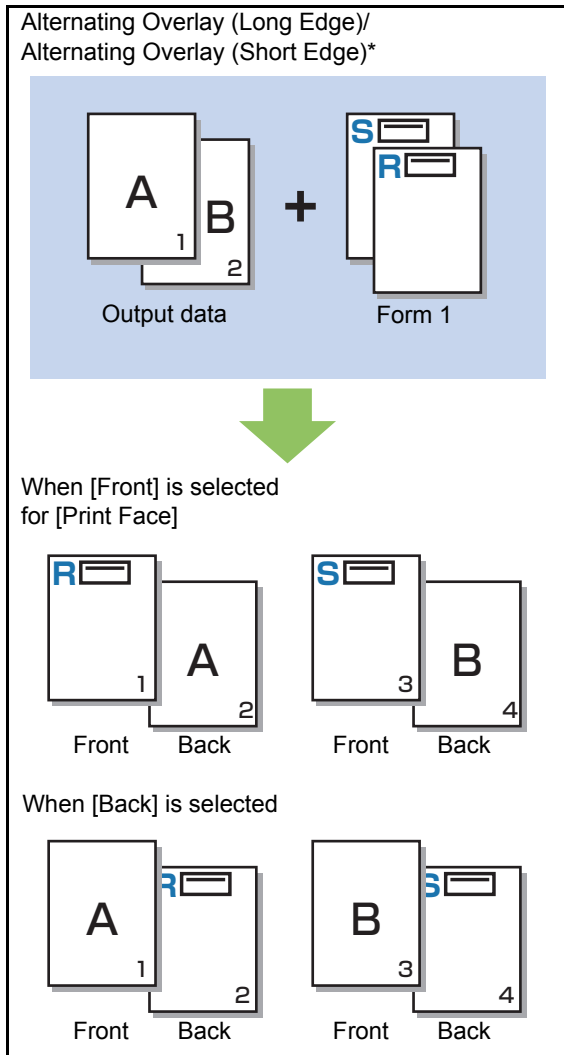

* The illustration is an example of long edge binding.

[Each Page + Alternating Overlay (Long Edge)]/[Each Page + Alternating Overlay (Short Edge)]

The form is overlaid on the output data on one side, and a different form is printed on the other side. You can specify the separate forms in [Form 1] and [Form 2].

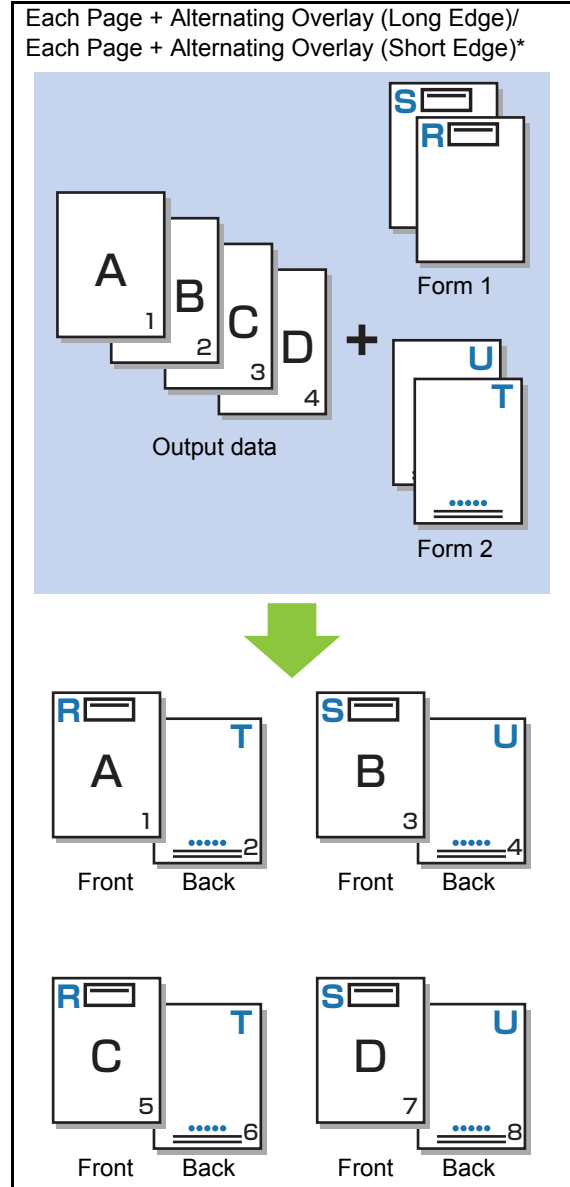

* The illustration is an example of long edge binding.



- This function is not available when [Mixed Size Original] is configured.
- This function is not available when [Combine] is configured.

■ Print Face

When [Alternating Overlay (Long Edge)]/[Alternating Overlay (Short Edge)] or [Each Page + Alternating Overlay (Long Edge)]/[Each Page + Alternating Overlay (Short Edge)] is selected in [Print Pattern], specify whether to print the form data on the front or back side of the paper.

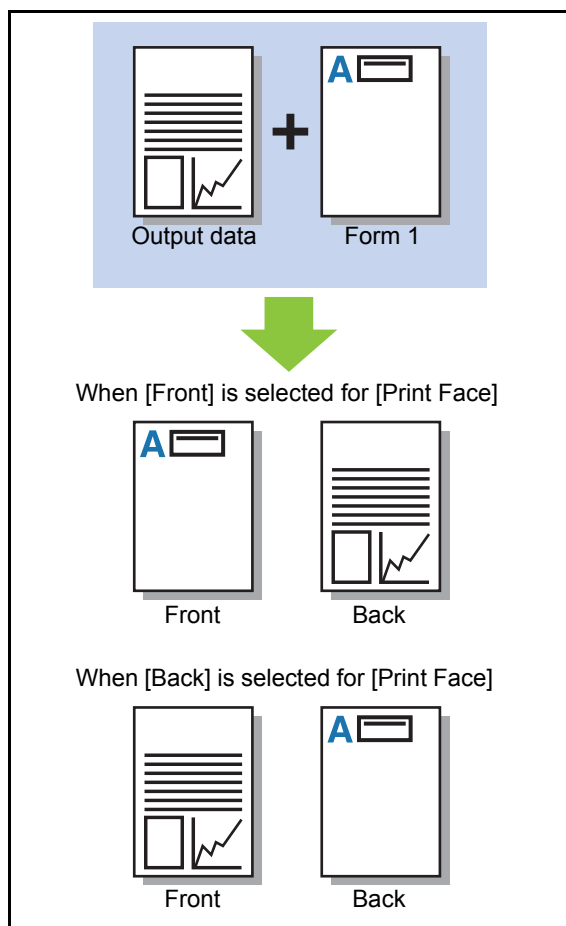

- When [Each Page + Alternating Overlay (Long Edge)]/[Each Page + Alternating Overlay (Short Edge)] is selected, specify the side on which to print only the form.

■ Preferred Layer

When [Each Page Overlay], [Each Page + Alternating Overlay (Long Edge)], or [Each Page + Alternating Overlay (Short Edge)] is selected for [Print Pattern], specify whether to assign priority to the form data or the output data, and overlay it on the other.

[None]

Priority is given to the output data or form data based on which is darker in color, and it is overlaid on top of the other.

[Document]

Priority is given to the output data (original) layer, and it is overlaid on top of the form data.

[Form]

Priority is given to the form data layer, and it is overlaid on top of the output data.



- If the image size of the priority layer is larger than that of the non-priority layer, the image of the non-priority layer may not be printed.
- If the output data and form data include the same colors, the parts of the image where those colors overlap may not be reproduced correctly.

Reverse Order

When the check box is selected, printouts are printed in reverse order.

[Environment] Tab

For more information on each setting item, see "[Environment] Tab" (p. 3-26) in "Print".

RISO Console Settings

You can use the [Form Data] screen in the [Storage] menu.

[Form Data] Screen

Displays the form data that have been sent by selecting [Form] in the [Output] setting of the RISO ComColor FW PS Printer Driver.

The RISO ComColor FW PS Printer Driver is available when the PostScript kit is installed.

[Delete]

Delete the selected form data from the list.

[Details]

You can check the settings of the selected form data. You can also change the settings.

Printable Files in the USB Flash Drive

When the PostScript kit is installed, you can print PRN files and PDF files that are saved on a USB flash drive.

Only the files that can be used are displayed on the document list screen on the machine.

■ Example of the Folder Structure in a USB flash Drive

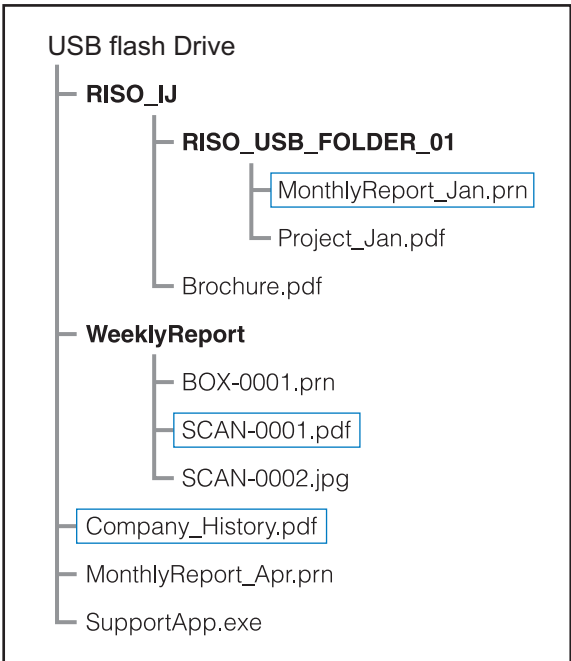

The folders are indicated in bold font.

The files inside the rectangles are displayed on the document list screen.



- The following types of files saved on a USB flash drive cannot be used:
 - PDF files that are protected with a password
 - PDF files whose job data is broken
 - PDF files that are saved in the [RISO_IJ] folder
 - PRN files that are saved outside the [RISO_IJ] folder

List of Settings in [USB] - [Load]

You can change the print settings for PDF files.

Select the folder on the [USB] - [Load] screen, and touch [Open] to display a list of the documents inside the folder. When you select a document and touch [Print Setting] in the sub menu, the setting screen is displayed. The settings that can be configured on this screen are listed below.

Setting item	Description	See
Color Mode	Select color or monochrome printing.	p. 1-7
Reproduction Size	Specify enlargement or reduction of original images before printing, if needed. [Fit to Paper] is not available.	p. 1-7
Paper Selection	Change the paper tray, paper type, and feed control settings according to the paper used for printing.	p. 1-7
Duplex / Simplex	Specify the sides of the paper that are printed on.	p. 3-9
Sort	Specify the sorting method when printing multiple copies.	p. 1-10
Print Density	Specify the print density.	p. 1-10
Combine	Impose continuous pages onto one sheet.	p. 1-13
Image Repeat	Impose multiple copies of the same original onto one sheet.	p. 1-13
Booklet	Specify the imposition setting when creating a booklet.	p. 1-14
Stamp	Stamp the page number or date in the header or footer.	p. 1-14
Add Cover	Specify this to add front and back covers to the printout.	p. 1-20
Separation	Insert slip sheets. When the optional face down finisher is connected, the offset output setting is also available.	p. 1-21
Binding Margin	Specify the binding margin.	p. 1-22
Staple	Specify the staple settings. (When using the optional face down finisher)	p. 8-6
Slow Printing	Decrease the printing speed. This also reduces the amount of noise produced by the machine when printing jobs.	p. 1-22
Output Tray	Select the output tray for printouts. (When using the optional stacking tray)	p. 8-11
Output Tray Relay	The output tray switches automatically when the tray that is being used becomes full. (When using the optional auto-control stacking tray)	p. 8-11
Auto Image Rotation	Rotate the image 90 degrees automatically when the orientation of the original and paper do not match.	p. 1-22

Font List

The fonts you can use are listed below.

PS Fonts

■ European Fonts

AlbertusMT
AlbertusMT-Italic
AlbertusMT-Light
AntiqueOlive-Bold
AntiqueOlive-Compact
AntiqueOlive-Italic
AntiqueOlive-Roman
Apple-Chancery
Arial-BoldItalicMT
Arial-BoldMT
Arial-ItalicMT
ArialMT
AvantGarde-Book
AvantGarde-BookOblique
AvantGarde-Demi
AvantGarde-DemiOblique
Bodoni
Bodoni-Bold
Bodoni-BoldItalic
Bodoni-Italic
Bodoni-Poster
Bodoni-PosterCompressed
Bookman-Demi
Bookman-Demitalic
Bookman-Light
Bookman-LightItalic
Carta
Chicago
Clarendon
Clarendon-Bold
Clarendon-Light
CooperBlack
CooperBlack-Italic
Copperplate-ThirtyThreeBC
Copperplate-ThirtyTwoBC
Coronet-Regular
Courier
Courier-Bold
Courier-BoldOblique

Courier-Oblique
Eurostile
Eurostile-Bold
Eurostile-BoldExtendedTwo
Eurostile-ExtendedTwo
Geneva
GillSans
GillSans-Bold
GillSans-BoldCondensed
GillSans-BoldItalic
GillSans-Condensed
GillSans-ExtraBold
GillSans-Italic
GillSans-Light
GillSans-LightItalic
Goudy
Goudy-Bold
Goudy-BoldItalic
Goudy-ExtraBold
Goudy-Italic
Helvetica
Helvetica-Bold
Helvetica-BoldOblique
Helvetica-Condensed
Helvetica-Condensed-Bold
Helvetica-Condensed-BoldObl
Helvetica-Condensed-Oblique
Helvetica-Narrow
Helvetica-Narrow-Bold
Helvetica-Narrow-BoldOblique
Helvetica-Narrow-Oblique
Helvetica-Oblique
HoeflerText-Black
HoeflerText-BlackItalic
HoeflerText-Italic
HoeflerText-Ornaments
HoeflerText-Regular
JoannaMT
JoannaMT-Bold
JoannaMT-BoldItalic
JoannaMT-Italic
LetterGothic
LetterGothic-Bold
LetterGothic-BoldSlanted
LetterGothic-Slanted
LubalinGraph-Book
LubalinGraph-BookOblique
LubalinGraph-Demi
LubalinGraph-DemiOblique

Marigold
 Monaco
 MonaLisa-Recut
 NewCenturySchlbk-Bold
 NewCenturySchlbk-BoldItalic
 NewCenturySchlbk-Italic
 NewCenturySchlbk-Roman
 NewYork
 Optima
 Optima-Bold
 Optima-BoldItalic
 Optima-Italic
 Oxford
 Palatino-Bold
 Palatino-BoldItalic
 Palatino-Italic
 Palatino-Roman
 StempelGaramond-Bold
 StempelGaramond-BoldItalic
 StempelGaramond-Italic
 StempelGaramond-Roman
 Symbol
 Tekton
 Times-Bold
 Times-BoldItalic
 Times-Italic
 Times-Roman
 TimesNewRomanPS-BoldItalicMT
 TimesNewRomanPS-BoldMT
 TimesNewRomanPS-ItalicMT
 TimesNewRomanPSMT
 Univers
 Univers-Bold
 Univers-BoldExt
 Univers-BoldExtObl
 Univers-BoldOblique
 Univers-Condensed
 Univers-CondensedBold
 Univers-CondensedBoldOblique
 Univers-CondensedOblique
 Univers-Extended
 Univers-ExtendedObl
 Univers-Light
 Univers-LightOblique
 Univers-Oblique
 Wingdings
 ZapfChancery-MediumItalic
 ZapfDingbats

■ Japanese Fonts

IPA Mincho
 IPA Gothic

■ PCL Fonts

Albertus Extra Bold
 Albertus Medium
 Antique Olive
 Antique Olive Bold
 Antique Olive Italic
 Arial
 Arial Bold
 Arial Bold Italic
 Arial Italic
 AvantGarde-Book
 AvantGarde-BookOblique
 AvantGarde-Demi
 AvantGarde-DemiOblique
 Bookman-Demi
 Bookman-DemiItalic
 Bookman-Light
 Bookman-LightItalic
 Calibri
 Calibri Bold
 Calibri Bold Italic
 Calibri Italic
 Cambria
 Cambria Bold
 Cambria Bold Italic
 Cambria Italic
 CG Omega
 CG Omega Bold
 CG Omega Bold Italic
 CG Omega Italic
 CG Times
 CG Times Bold
 CG Times Bold Italic
 CG Times Italic
 Clarendon Condensed Bold
 Coronet
 Courier
 CourierPS
 Courier Bold
 Courier Bold Italic
 Courier Italic
 CourierPS-Bold
 CourierPS-BoldOblique
 CourierPS-Oblique

Chapter 8 Optional Equipment

Garamond Antiqua
Garamond Halbfett
Garamond Kursiv
Garamond Kursiv Halbfett
Helvetica
Helvetica-Bold
Helvetica-BoldOblique
Helvetica-Narrow
Helvetica-Narrow-Bold
Helvetica-Narrow-BoldOblique
Helvetica-Narrow-Oblique
Helvetica-Oblique
Letter Gothic
Letter Gothic Bold
Letter Gothic Italic
Marigold
NewCenturySchlbk-Bold
NewCenturySchlbk-BoldItalic
NewCenturySchlbk-Italic
NewCenturySchlbk-Roman
Palatino-Bold
Palatino-BoldItalic
Palatino-Italic
Palatino-Roman
Symbol
Symbol IPS
Times New Roman
Times New Roman Bold
Times New Roman Bold Italic
Times New Roman Italic
Times-Bold
Times-BoldItalic
Times-Italic
Times-Roman
Univers Bold
Univers Bold Italic
Univers Condensed Bold
Univers Condensed Bold Italic
Univers Condensed Medium
Univers Condensed Medium Italic
Univers Medium
Univers Medium Italic
Wingdings
ZapfChancery-MediumItalic
ZapfDingbats

This chapter describes how to replace ink cartridges and includes information about machine specifications, consumables, as well as an index.

About Ink Cartridges..... p. 9-2

This section describes how to replace ink cartridges.

Specifications..... p. 9-3

This section describes the specifications of the ComColor FW Series and optional equipment.

Consumables..... p. 9-12

This section describes the specifications of ink cartridges and spare staples.

Index..... p. 9-13



9

Appendix

About Ink Cartridges

Ink Cartridge Replacement

When ink runs out, the ink replacement message is displayed and printing stops. Replace the cartridge of the color shown.



- Do not remove the ink cartridge until the ink replacement message is displayed.



- When the remaining amount of ink is low, the remaining ink indicator on the touch panel screen flashes. Prepare a new ink cartridge for the color that flashes.

1 Open the front cover.

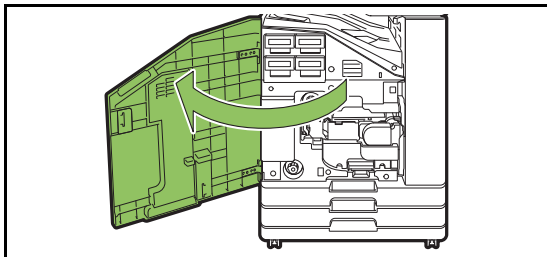

2 Remove the ink cartridge identified as empty.

Confirm the color of the ink cartridge.

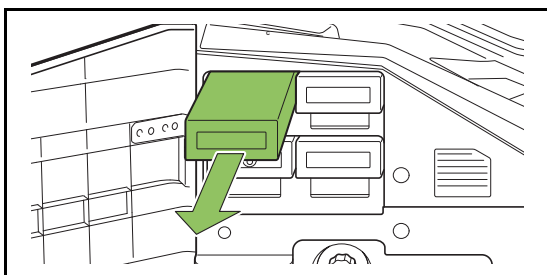

3 Remove the cap of the new ink cartridge.

Affix the removed cap on the old ink cartridge.

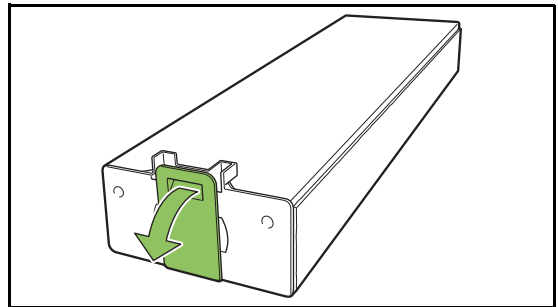

4 Insert the new ink cartridge.

Position the ink cartridge so that the ▼ mark faces upward, and insert it until it stops.

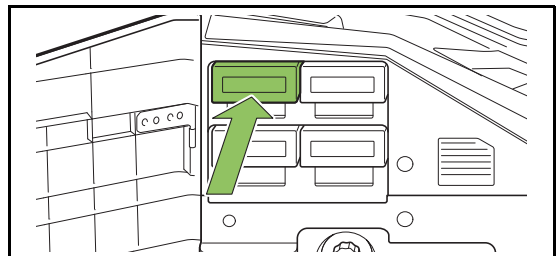

5 Close the front cover.

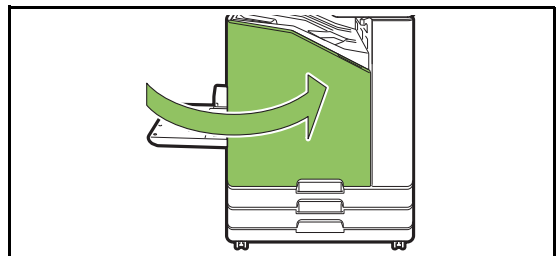

Specifications

■ ComColor FW5230/FW5230R Specifications

Basic Functions and Print Functions

Model Name	ComColor FW5230/FW5230R: 62A01		
Type	Console		
Color Support	Full color (Cyan, Magenta, Yellow, Black)		
Print Type	Line-type inkjet system		
Ink Type	Oil-based pigment ink (Cyan, Magenta, Yellow, Black)		
Resolution	Standard: 300 dpi (main scanning direction) × 300 dpi (sub-scanning direction) Fine: 300 dpi (main scanning direction) × 600 dpi (sub-scanning direction)		
Number of Gray Levels	For each CMYK color (11 gray levels)		
Data Processing Resolution	Standard: 300 dpi × 300 dpi Fine: 600 dpi × 600 dpi Line smoothing: 600 dpi × 600 dpi		
Warm-up Time	2 min. 30 sec. or less (at room temperature of 23°C (73.4°F))		
First Print Time ^{*1}	5 sec or less (A4-LEF)		
Continuous Print Speed ^{*2*6}	A4-LEF ^{*8}	Simplex: 120 ppm	Duplex: 60 sheets/minute
	Letter-LEF	Simplex: 120 ppm	Duplex: 60 sheets/minute
	A4	Simplex: 90 ppm	Duplex: 45 sheets/minute
	Letter	Simplex: 90 ppm	Duplex: 45 sheets/minute
	JIS-B4	Simplex: 76 ppm	Duplex: 34 sheets/minute
	A3	Simplex: 66 ppm	Duplex: 32 sheets/minute
	Ledger	Simplex: 65 ppm	Duplex: 32 sheets/minute
Paper Size	Standard Tray	Maximum: 340 mm × 550 mm (13 3/8" × 21 5/8") Minimum: 90 mm × 148 mm (3 9/16" × 5 27/32")	
	Feed Tray	Maximum: 297 mm × 432 mm (11 11/16" × 17") Minimum: 182 mm × 182 mm (7 3/16" × 7 3/16")	
Printable Area	Maximum: 310 mm × 544 mm (12 3/16" × 21 13/32")		
Guaranteed Print Area ^{*3}	Standard: Margin width of 5 mm (7/32") Maximum: Margin width of 3 mm (1/8")		
Paper Weight	Standard Tray	46 g/m ² (12-lb bond) to 210 g/m ^{2*9} (56-lb bond) (plain paper)	
	Feed Tray	52 g/m ² (14-lb bond) to 104 g/m ^{2*9} (28-lb bond) (plain paper)	
Paper Tray Capacity	Standard Tray	Height up to 110 mm (4 5/16")	
	Feed Tray	Height up to 56 mm (2 3/16") (2 trays)	
Output Tray Capacity	Height up to 56 mm (2 3/16")		
PDL (Page Description Language)	RISORINC/C IV		
Supported Protocols	TCP/IP, HTTP, HTTPs, DHCP, ftp, lpr, IPP, SNMP, Port 9100 (RAW port), IPv4, IPv6, IPsec		
Network Interface	Ethernet 1000BASE-T, 100BASE-TX, 10BASE-T (2ch)		
Memory Capacity	4 GB		

Hard Disk ^{*5}	Capacity	500 GB
	Available Space	Approx. 430 GB
Operating System		Linux
Power Source		AC 100-240 V, 10.0-5.0 A, 50-60 Hz
Power Consumption		Max. 1,000 W
		Ready ^{*4} : 150 W or less Sleep ^{*7} : 4 W or less Stand-by: 0.5 W or less
Operating Noise		Max. 65 dB (A) A4-LEF (Simplex) at the maximum print speed
A-weighted Sound Power Level ^{*10}		Max. 75 dB A4-LEF (Simplex) Monochrome/Color: 120 ppm
Operating Environment		Temperature: 15°C to 30°C (59°F to 86°F) Humidity: 40% to 70% RH (non-condensing)
Dimensions (W × D × H)		In use: 1,030 mm × 725 mm × 1,115 mm (40 19/32" × 28 9/16" × 43 29/32") With cover and tray closed: 775 mm × 705 mm × 970 mm (30 17/32" × 27 25/32" × 38 7/32")
Weight		Approx. 135 kg (297 lb)
Safety Information		IEC60950-1 compliant, Indoor, pollution degree 2*, At altitudes of 2,000 m or lower * The pollution degree of the usage environment due to dirt and dust in the air. Degree "2" corresponds to a general indoor environment.
Dimensions When Operating (W × D × H)		With the front cover open and the operation panel in the upright position: 1,305 mm × 1,215 mm × 1,115 mm (51 13/32" × 47 27/32" × 43 29/32")

*1 Within 10 minutes after the last print job

*2 When using plain paper and recycled paper (85 g/m² (23-lb bond)), and density setting 3 (Standard)
Chart used: Print measurement pattern [Color measurement sample 2 (JEITA standard pattern J6)]

*3 The margin when printing envelopes is 10 mm (3/8").
The guaranteed area when printing images is the area enclosed within 5 mm (7/32") of the edges of the paper.

*4 Without printing and temperature adjustment operation

*5 One gigabyte (GB) is calculated as 1 billion bytes.

*6 The continuous print speed varies depending on the type of optional output equipment connected.
Face down finisher: Without offset: 120 sheets/minute (A4-LEF Simplex)
Offset output: 105 sheets/minute (A4-LEF Simplex)

*7 When setting [Power Consumption (in sleep)] to [Low].

*8 LEF stands for Long edge feed.

*9 Duplex printing is not guaranteed with thick paper weighing 104 g/m² or greater.

*10 When using plain paper (62 g/m² (17-lb bond))

■ ComColor FW5231/FW5231R Specifications

Basic Functions and Print Functions

Model Name		ComColor FW5231/FW5231R: 62A02	
Type		Console	
Color Support		Full color (Cyan, Magenta, Yellow, Black)	
Print Type		Line-type inkjet system	
Ink Type		Oil-based pigment ink (Cyan, Magenta, Yellow, Black)	
Resolution		Standard: 300 dpi (main scanning direction) × 300 dpi (sub-scanning direction) Fine: 300 dpi (main scanning direction) × 600 dpi (sub-scanning direction)	
Number of Gray Levels		For each CMYK color (11 gray levels)	
Data Processing Resolution		Standard: 300 dpi × 300 dpi Fine: 600 dpi × 600 dpi Line smoothing: 600 dpi × 600 dpi	
Warm-up Time		2 min. 30 sec. or less (at room temperature of 23°C (73.4°F))	
First Print Time* ¹		5 sec or less (A4-LEF)	
Continuous Print Speed* ^{2*6}	A4-LEF* ⁸	Simplex: 120 ppm	Duplex: 60 sheets/minute
	Letter-LEF	Simplex: 120 ppm	Duplex: 60 sheets/minute
	A4	Simplex: 90 ppm	Duplex: 45 sheets/minute
	Letter	Simplex: 90 ppm	Duplex: 45 sheets/minute
	JIS-B4	Simplex: 76 ppm	Duplex: 34 sheets/minute
	A3	Simplex: 66 ppm	Duplex: 32 sheets/minute
	Ledger	Simplex: 65 ppm	Duplex: 32 sheets/minute
Paper Size	Standard Tray	Maximum: 340 mm × 550 mm (13 3/8" × 21 5/8") Minimum: 90 mm × 148 mm (3 9/16" × 5 27/32")	
Printable Area		Maximum: 310 mm × 544 mm (12 3/16" × 21 13/32")	
Guaranteed Print Area* ³		Standard: Margin width of 5 mm (7/32") Maximum: Margin width of 3 mm (1/8")	
Paper Weight	Standard Tray	46 g/m ² (12-lb bond) to 210 g/m ^{2*9} (56-lb bond) (plain paper)	
Paper Tray Capacity	Standard Tray	Height up to 110 mm (4 5/16")	
Output Tray Capacity		Height up to 56 mm (2 3/16")	
PDL (Page Description Language)		RISORINC/C IV	
Supported Protocols		TCP/IP, HTTP, HTTPs, DHCP, ftp, lpr, IPP, SNMP, Port 9100 (RAW port), IPv4, IPv6, IPsec	
Network Interface		Ethernet 1000BASE-T, 100BASE-TX, 10BASE-T (2ch)	
Memory Capacity		4 GB	
Hard Disk* ⁵	Capacity	500 GB	
	Available Space	Approx. 430 GB	
Operating System		Linux	
Power Source		AC 100-240 V, 10.0-5.0 A, 50-60 Hz	

Power Consumption	Max. 1,000 W Ready ^{*4} : 150 W or less Sleep ^{*7} : 4 W or less Stand-by: 0.5 W or less
Operating Noise	Max. 65 dB (A) A4-LEF (Simplex) at the maximum print speed
A-weighted Sound Power Level ^{*10}	Max. 75 dB A4-LEF (Simplex) Monochrome/Color: 120 ppm
Operating Environment	Temperature: 15°C to 30°C (59°F to 86°F) Humidity: 40% to 70% RH (non-condensing)
Dimensions (W × D × H)	In use: 1,030 mm × 725 mm × 1,115 mm (40 19/32" × 28 9/16" × 43 29/32") With cover and tray closed: 775 mm × 705 mm × 970 mm (30 17/32" × 27 25/32" × 38 7/32")
Weight	Approx. 130 kg (286 lb)
Safety Information	IEC60950-1 compliant, Indoor, pollution degree 2*, At altitudes of 2,000 m or lower * The pollution degree of the usage environment due to dirt and dust in the air. Degree "2" corresponds to a general indoor environment.
Dimensions When Operating (W × D × H)	With the front cover open and the operation panel in the upright position: 1,305 mm × 1,215 mm × 1,115 mm (51 13/32" × 47 27/32" × 43 29/32")

- *1 Within 10 minutes after the last print job
- *2 When using plain paper and recycled paper (85 g/m² (23-lb bond)), and density setting 3 (Standard)
Chart used: Print measurement pattern [Color measurement sample 2 (JEITA standard pattern J6)]
- *3 The margin when printing envelopes is 10 mm (3/8").
The guaranteed area when printing images is the area enclosed within 5 mm (7/32") of the edges of the paper.
- *4 Without printing and temperature adjustment operation
- *5 One gigabyte (GB) is calculated as 1 billion bytes.
- *6 The continuous print speed varies depending on the type of optional output equipment connected.
Face down finisher: Without offset: 120 sheets/minute (A4-LEF Simplex)
Offset output: 105 sheets/minute (A4-LEF Simplex)
- *7 When setting [Power Consumption (in sleep)] to [Low].
- *8 LEF stands for Long edge feed.
- *9 Duplex printing is not guaranteed with thick paper weighing 104 g/m² or greater.
- *10 When using plain paper (62 g/m² (17-lb bond))

■ ComColor FW5000/FW5000R Specifications

Basic Functions and Print Functions

Model Name		ComColor FW5000/FW5000R: 62A03
Type		Console
Color Support		Full color (Cyan, Magenta, Yellow, Black)
Print Type		Line-type inkjet system
Ink Type		Oil-based pigment ink (Cyan, Magenta, Yellow, Black)
Resolution		Standard: 300 dpi (main scanning direction) × 300 dpi (sub-scanning direction) Fine: 300 dpi (main scanning direction) × 600 dpi (sub-scanning direction)
Number of Gray Levels		For each CMYK color (11 gray levels)
Data Processing Resolution		Standard: 300 dpi × 300 dpi Fine: 600 dpi × 600 dpi Line smoothing: 600 dpi × 600 dpi
Warm-up Time		2 min. 30 sec. or less (at room temperature of 23°C (73.4°F))
First Print Time* ¹		5 sec or less
Continuous Print Speed* ^{2*6}	A4/Letter	Simplex: 90 ppm Duplex: 45 sheets/minute
Paper Size	Standard Tray	Maximum: 340 mm × 550 mm (13 3/8" × 21 5/8") Minimum: 90 mm × 148 mm (3 9/16" × 5 27/32")
	Feed Tray	Maximum: 297 mm × 432 mm (11 11/16" × 17") Minimum: 182 mm × 182 mm (7 3/16" × 7 3/16")
Printable Area		Maximum: 210 mm × 544 mm (8 3/16" × 21 13/32")
Guaranteed Print Area* ³		Standard: Margin width of 5 mm (7/32") Maximum: Margin width of 3 mm (1/8")
Paper Weight	Standard Tray	46 g/m ² (12-lb bond) to 210 g/m ^{2*9} (56-lb bond) (plain paper)
	Feed Tray	52 g/m ² (14-lb bond) to 104 g/m ^{2*9} (28-lb bond) (plain paper)
Paper Tray Capacity	Standard Tray	Height up to 110 mm (4 5/16")
	Feed Tray	Height up to 56 mm (2 3/16") (2 trays)
Output Tray Capacity		Height up to 56 mm (2 3/16")
PDL (Page Description Language)		RISORINC/C IV
Supported Protocols		TCP/IP, HTTP, HTTPS, DHCP, ftp, lpr, IPP, SNMP, Port 9100 (RAW port), IPv4, IPv6, IPsec
Network Interface		Ethernet 1000BASE-T, 100BASE-TX, 10BASE-T (2ch)
Memory Capacity		4 GB
Hard Disk* ⁵	Capacity	500 GB
	Available Space	Approx. 430 GB
Operating System		Linux
Power Source		AC 100-240 V, 10.0-5.0 A, 50-60 Hz
Power Consumption		Max. 1,000 W Ready* ⁴ : 150 W or less Sleep* ⁷ : 4 W or less Stand-by: 0.5 W or less
Operating Noise		Max. 65 dB (A) A4-LEF* ⁸ (Simplex) at the maximum print speed
A-weighted Sound Power Level* ¹⁰		Max. 75 dB A4-LEF (Simplex) Monochrome/Color: 120 ppm

Operating Environment	Temperature: 15°C to 30°C (59°F to 86°F) Humidity: 40% to 70% RH (non-condensing)
Dimensions (W × D × H)	In use: 1,030 mm × 725 mm × 1,115 mm (40 19/32" × 28 9/16" × 43 29/32") With cover and tray closed: 775 mm × 705 mm × 970 mm (30 17/32" × 27 25/32" × 38 7/32")
Weight	135 kg (297 lb)
Safety Information	IEC60950-1 compliant, Indoor, pollution degree 2*, At altitudes of 2,000 m or lower * The pollution degree of the usage environment due to dirt and dust in the air. Degree "2" corresponds to a general indoor environment.
Dimensions When Operating (W × D × H)	With the front cover open and the operation panel in the upright position: 1,305 mm × 1,215 mm × 1,115 mm (51 13/32" × 47 27/32" × 43 29/32")

- *1 Within 10 minutes after the last print job
- *2 When using plain paper and recycled paper (85 g/m² (23-lb bond)), and density setting 3 (Standard)
Chart used: Print measurement pattern [Color measurement sample 2 (JEITA standard pattern J6)]
- *3 The margin when printing envelopes is 10 mm (3/8").
The guaranteed area when printing images is the area enclosed within 5 mm (7/32") of the edges of the paper.
- *4 Without printing and temperature adjustment operation
- *5 One gigabyte (GB) is calculated as 1 billion bytes.
- *6 The continuous print speed varies depending on the type of optional output equipment connected.
Face down finisher: Without offset: 90 sheets/minute (A4 Simplex)
Offset output: 82 sheets/minute (A4 Simplex)
- *7 When setting [Power Consumption (in sleep)] to [Low].
- *8 LEF stands for Long edge feed.
- *9 Duplex printing is not guaranteed with thick paper weighing 104 g/m² or greater.
- *10 When using plain paper (62 g/m² (17-lb bond))

■ Scanner HS7000 (Optional)

Copy Functions and Scan Functions

Type	Flat Bed Scanner with Automatic Document Feeder (ADF)	
Scanning Modes	Copy mode: Color, Monochrome, Auto, Cyan, Magenta Scan mode: Color, Monochrome, Auto, Grayscale	
Scanning Resolution	600 dpi, 400 dpi, 300 dpi, or 200 dpi	
Maximum Scanning Area	303 mm × 432 mm (11 15/16" × 17") (when using platen glass) 295 mm × 430 mm (11 5/8" × 16 15/16") (when using ADF)	
Copy Functions	Writing Resolution	Standard: 300 dpi × 300 dpi Fine: 300 dpi × 600 dpi
	Copy Paper Size	Maximum: 303 mm × 432 mm (11 15/16" × 17") (equivalent to A3)
	First Copy Time	Monochrome/Color: 7 sec or less (when copying A4-LEF/Letter-LEF orientation using Color Priority Mode)
	Scanning Speed	Simplex copying (A4-LEF/Letter-LEF, using ADF): 70 ppm or higher Duplex copying (A4-LEF/Letter-LEF, using ADF): 70 ppm or higher
	Reproduction Size	50% to 200% (Copy mode)
ADF	Type	Original source displacement (capable of scanning both sides of a document by simultaneous duplex scanning)
	Original Size	Maximum: 297 mm × 432 mm (11 11/16" × 17") (equivalent to A3) Minimum: 100 mm × 148 mm (3 15/16" × 5 27/32")
	Paper Weight	52 g/m ² (14-lb bond) to 128 g/m ² (34-lb bond)
	Original Capacity	80 g/m ² (21-lb bond) : Max. 200 sheets Height up to 25 mm (1")
Scan Functions	Scanning Gray Levels	10-bit input and 8-bit output for each RGB color
	Scanning Speed	Monochrome/Color: 100 ppm * RISO KAGAKU standard original (A4-LEF/Letter-LEF), 300 dpi, JPEG, PDF, when stored to main unit hard drive
	Network Interface* ¹	Ethernet 1000BASE-T/100BASE-TX/10BASE-T
	Data-saving Method* ¹	Save to main unit hard drive, server, or USB flash drive, or send by e-mail
	Data-saving Format* ¹	Monochrome: TIFF, PDF, PDF/A Grayscale/Full Color: TIFF, JPEG, PDF, PDF/A
Power Source	AC 100-240 V, 1.2-0.6 A, 50-60 Hz	
Power Consumption	Max. 100 W	
Dimensions (W × D × H)	640 mm × 560 mm × 255 mm (25 3/16" × 22 1/16" × 10 1/32")	
Weight	Approx. 25 kg (55 lb)	
Safety Information	IEC60950-1 compliant, Indoor, pollution degree 2*, At altitudes of 2,000 m or lower * The pollution degree of the usage environment due to dirt and dust in the air. Degree "2" corresponds to a general indoor environment.	
Dimensions When Operating (when connected to main unit) (W × D × H)	In use: 1,065 mm × 830 mm × 1,260 mm (41 15/16" × 32 21/32" × 49 5/8") With the front cover open and the operation panel in the upright position: 1,305 mm × 1,325 mm × 1,635 mm (51 13/32" × 52 3/16" × 64 3/8")	

*1 Via the internal host controller

■ Face Down Finisher F10 (Optional)

Type	External Unit
Finishing Functions	Offset output, staple
Applicable Paper Size	Without offset Maximum: 340 mm × 550 mm (13 3/8" × 21 5/8") Minimum: 90 mm × 148 mm (3 9/16" × 5 27/32")
	Offset output Regular sized paper width: 182 mm × 257 mm (7 3/16" × 10 1/8") - 297 mm × 431.8 mm (11 11/16" × 17") Irregular sized paper width: 131 mm × 148 mm (5 3/16" × 5 27/32") - 305 mm × 550 mm (12" × 21 5/8")
Paper Weight	46 g/m ² (12-lb bond) to 210 g/m ² (56-lb bond) (plain paper, recycled paper, postcards)
Tray Capacity	Height up to 108 mm (4 1/4")
Maximum Number of Staples	50 sheets ^{*1} A4, A4-LEF, JIS-B5, JIS-B5-LEF, Letter, Letter-LEF 25 sheets ^{*1} A3, JIS-B4, Ledger, Legal, Foolscap
Applicable Paper Size for Staple	A3, JIS-B4, A4, A4-LEF, JIS-B5, JIS-B5-LEF, Ledger, Legal, Letter, Letter-LEF, Foolscap
Paper Weight for Staple	52 g/m ² (14-lb bond) to 210 g/m ² (56-lb bond) (plain paper, recycled paper)
Staple Position	1 at front side (angle stapling) / 1 at rear side (angle stapling) 2 at center (parallel stapling)
Power Source	AC 100-240 V, 1.1-0.5 A, 50-60 Hz
Power Consumption	Max. 100 W
Dimensions (W × D × H)	635 mm × 695 mm × 580 mm (25" × 27 3/8" × 22 13/16")
Weight	Approx. 35 kg (77 lb)
Safety Information	IEC60950-1 compliant, Indoor, pollution degree 2*, At altitudes of 2,000 m or lower * The pollution degree of the usage environment due to dirt and dust in the air. Degree "2" corresponds to a general indoor environment.
Dimensions When Operating (when Connected to main unit) (W × D × H)	1,420 mm × 1,220 mm × 1,315 mm (55 29/32" × 48 1/32" × 51 25/32")

*1 When using plain paper and recycled paper (85 g/m² (23-lb bond))

■ IC Card Authentication Kit II (Optional)

Applicable Card	ISO 14443 TypeA/TypeB/TypeC (FeliCa [®] /Mifare [®])
Radio Law Category	Guided read-write communication equipment
Power Source	Power supplied from the USB port
Operating Environment	Temperature: 15°C to 30°C (59°F to 86°F) Humidity: 40% to 70% RH (non-condensing)
Dimensions (W × D × H)	93 mm × 65 mm × 19 mm (3 21/32" × 2 9/16" × 3/4") (excluding protruding parts)
Weight	Approx. 90 g (3 oz)

■ PS Kit FG10 (Optional)

Compatible Printers	ComColor FW series
Type	RIP option
PDL (Page Description Language)	PostScript [®] Level3 (CPSI:3019) *1 PDF (1.7) PCL/PCL XL (PCL5c 1.38) TIFF (6.0)
Supported Protocols	TCP/IP, HTTP, HTTPS, DHCP, ftp, lpr, IPP, SNMP, Port9100 (RAW port), IPv4, IPv6, IPsec
Installed Fonts	PS: 136 Roman fonts and 2 Japanese fonts PCL: 88 Roman fonts

*1 Genuine Adobe engine

Consumables

It is recommended that you use the consumable products listed below.
 Consumable specifications and types are subject to change without notice.
 For pricing information, please contact your dealer or authorized service representative.

Ink Cartridges

Type	Color	Quantity	Unit
ComColor FW Ink Cartridge	Cyan Magenta Yellow Black	NET. 1,000 ml	1 piece
	Cyan Magenta Yellow Black	NET. 500 ml	
ComColor FW Ink Cartridge (E)	Cyan Magenta Yellow Black	NET. 1,000 ml	
ComColor FW Ink Cartridge R	Cyan Magenta Yellow Black	NET. 1,000 ml	
ComColor FW Ink Cartridge R (E)	Cyan Magenta Yellow Black	NET. 1,000 ml	

Use the ink cartridge within 24 months from the date of manufacture (when preserved under room temperature).
 For optimal printing quality, we recommend that you use the ink cartridge as soon as possible after purchase.
 You can find the date of manufacture on the ink cartridge.

Staple Cartridge

Spare staples for Face Down Finisher F10.

Type	Quantity
ComColor Staple 50	15,000 Pieces/Box

Index

A

- Add cover 1-20, 3-20
- Additional copy 1-24
- Address book
 - adding to the address book 2-11
 - editing the address book 2-11
- Address/destination 2-3
- ADF original guide 13
- ADF original output tray 13
- ADF original unit lever 13
- ADF scan & pause 1-11
- Admin menu button 15
- Admin menu screen 21
- Advanced tab 3-24
- Auto document feeder (ADF) 13
- Auto image rotation 1-22
- Auto-control stacking tray 8-8

B

- Barcode
 - barcode area definition 3-22
 - installing the Barcode Area Definition Software 7-2
 - operations 7-4
 - printing barcode originals 7-8
- Base color level 1-18, 2-9
- Basic tab 3-9
- Between jobs 3-20
- Between sorts 3-20
- Binding 1-20, 3-19
- Binding edge 1-20, 3-19, 8-5, 8-6
- Binding margin 1-22, 8-7
- Black 1-7, 2-7, 3-9
- Blank page detection 3-25
- Book shadow erasure 1-12, 2-8
- Booklet 1-14, 3-16

C

- Canceling copying 1-3
- Card-IJ 3-12
- Center margin 1-14
- Change setting screen 17
- Changing settings
 - during copying 1-3
 - during printing 3-3
- Changing the feed tray setting 1-8
- Changing the login password 26, 6-8
- Check amount 3-29
- Check setting 1-25, 2-10
- Checking the charge count 6-7
- Checking the current status of a job 31
- Checking the detailed count 6-7

- Chroma 3-22
- Clear key 14
- Clearing defaults 1-27
- Collated 1-10, 3-10
- Color mode 1-7, 2-7, 3-9
- Color profile 3-12
- Combine 1-13, 3-15
- Consumables 9-12
- Consumables screen 22, 6-6
- Contrast 3-22
- Copies 3-10
- Copy screen 16
- Copy, canceling 1-3
- Custom
 - specifying a custom paper size 3-11
 - specifying a custom size 3-10
- Custom menu 1-25, 2-10
- Custom paper entry 3-27
- Cyan 1-7, 3-9

D

- Data compression 3-21
- Data lamp 14
- Date 15
- Deleting an address/save destination 2-12
- Destination 3-12
- Document name 2-6
- Dot process 3-22
- Double-feed check 1-8
- Downloading scanned jobs to a computer 6-9
- Draft 3-21
- Duplex/simplex 1-10, 2-8, 3-9

E

- Editing button order 1-27
- Envelope imaging 3-24
- Envelope, printing 28
- Environment tab 3-26
- Error diffusion 3-22
- Error lamp 14
- External system job 3-29

F

- Face down finisher 8-2
- Face down finisher socket 8-2
- Face down tray 12
- Favorite 1-24
 - adding as a favorite 1-25
 - edit favorites 1-26
- Favorites tab 3-14
 - add to favorites 3-13
 - edit favorites 3-14

list of the favorites 3-14

Feed tray 13

 change settings 1-8

File format 2-7

File format for saving the scanned data 2-7

Finished screen 6-12

Folder entry 3-28

FORCEJET™ link icon 15

Form overlay 8-18

Front cover 13

Front cover release 13, 21

Full color 1-7, 2-7, 3-9

Function keys 14

G

Gamma correction 1-17, 2-9, 3-22

Grayscale 2-7

H

Halftone 3-22

HDD usage 18

Head cleaning 21, 6-13

High quality 3-12

Home key 14

Home screen 15

I

IJ paper 3-12

Image control 1-17, 2-9

Image position 1-18, 3-18

Image quality 1-16, 3-21

Image repeat 1-13, 3-15

Image shift 8-16

Image tab 3-21

Ink cartridges 9-12

Interrupt copy 1-23

Interrupt key 14

IP address 6-6

J

Jam release cover 8-2

Job comment 3-25

Job icon 31

Job list 31

Job name 3-24

L

Layout tab 3-15

Left cover 13

Left to right 3-16

License info screen 22, 6-8

Lightness 3-22

Line smoothing 3-21

Load screen 6-11

Loading orientation of the paper 8-5

Loading the next copy job 1-3

Login 26

Login/logout key 14

Lower right cover 13

M

Mac address 3-26, 6-6

Machine Info screen 22

Magenta 1-7, 3-9

Main power lamp 14

Main power switch 13

Main unit 12

Main unit socket 13

Maintenance button 15

Maintenance menu screen 6-13

Maintenance screen 21

Matt coated 3-12

Mixed size original 1-11, 2-8

Mode buttons 15

N

Network connection 3-29

Numeric keys 14

O

Offline icon 15

Offset output 8-6

Offset output (program) 8-6

Online/offline 3-29

Operation panel 13, 14

Orientation 3-10

Original cover 12

Original orientation 1-9, 2-8, 8-6

Original size 3-10

Original type 1-16, 2-9, 3-21

Output and destination 3-12

Output tray 1-22, 8-11

Output tray relay 1-22, 8-11

Owner 3-24

P

Page border 1-16

Page split 1-12, 2-8

Paper arranger 8-8

Paper feed guide lever 13

Paper feed pressure adjustment lever 12

Paper guide (end) 8-8

Paper guide (side) 8-8

Paper guide control 8-11

Paper guide open button 8-8

Paper size 3-11

Paper tray relay 1-22

Paper type 1-7, 1-9, 3-12

Paper, loading 26

Performing maintenance during copying	1-4
PIN code	2-9, 3-24
Platen glass	12
PostScript kit	8-12
Power key	14
Power-saving features	25
Print and pause	3-10
Print density	1-10, 3-21
Print menu screen	6-10
Print screen	17
Printer driver screen	3-5
Program	1-18, 3-25

R

Remaining amount of ink	15
Reproduction size	1-7
Reset key	14
Resolution	2-8
Right to left	3-16
RISO Console	
common button operations	6-4
login	6-4
starting the RISO Console	6-3
Rotation	3-18

S

Sample copy	1-25
Save as a default	1-26
Save as a file	3-12
Save to USB drive	3-12
Scan menu screen	6-9
Scan screen	16
Scanner	12
Scanner lamp	12
Scanning level	1-10, 2-8
Scanning size	1-9, 2-7
Screening	3-22
Separation	1-21
Slip sheet	1-19, 3-20
Slow printing	1-22, 3-25
Sort	1-10, 3-10, 3-11
Stamp	1-14, 3-17
Stamping	1-15
Stamping the date	1-15, 3-18
Stamping the page number	1-15, 3-17
Standard tray	12
adding paper	29
switching paper	29
Standard tray descent button	12
Standard tray paper guide	12
Staple	1-22, 8-4
Staple function and loading orientation of the paper	8-5
Start key	14
Status key	14
Stop key	14
Stopper	27

Storage	3-12
Storage screen	18
Storage, load	
copy to folder	4-8
copy to USB drive	4-8
document list screen	19
folder list screen	19
search documents	4-7
settings	4-5
Storage, save	
adding folder	4-6
change setting screen	18
document list screen	18
folder list screen	18
settings	4-4
System info button	15
System info menu	6-6
System info screen	22, 6-6

T

Tab	3-5
Text, entering	24
Top side left	1-9
Top side up	1-9
Top/bottom	3-16
Touch panel	14, 23
Tray selection per page	8-15

U

Uncollated	1-10, 3-10
Upper right cover	13
USB port	13
USB screen	20
USB, load	
change setting screen	21
copy to folder	5-7
document list screen	20
settings	5-5, 8-23
USB, save	
setting screen	20
settings	5-4
User info screen	22, 6-7
User name	15

V

Version	3-26
View balance	22

W

Waiting job list screen	17
Wake up key	14
Watermark	3-16
Wide staking tray	8-8

Z

Zoom 3-11



Please contact the following for supplies and service: