

*F610  
Inserter*

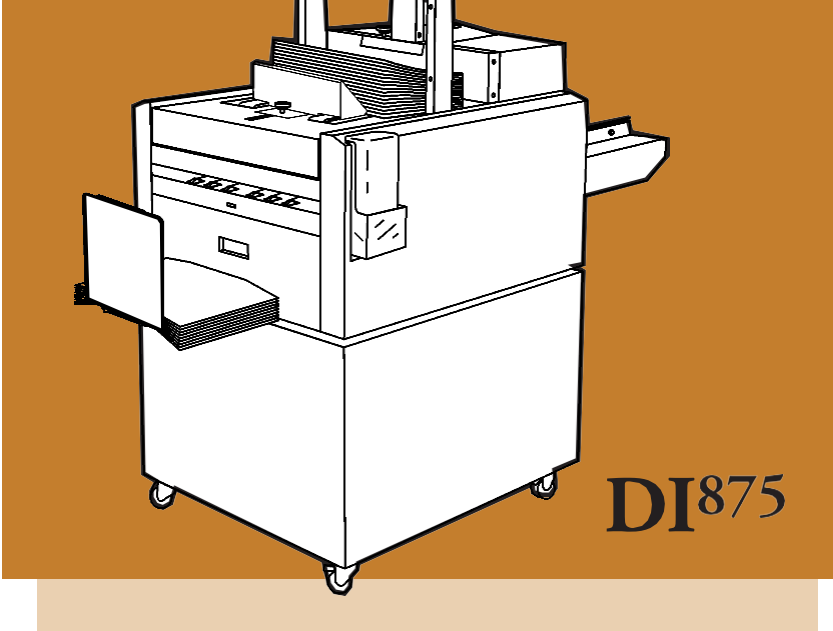

**DI875**

<b>1. Introduction</b>	page
1.1 Safety	2
<b>2. Getting to know the F610</b>	
2.1 Main components	3
2.2 The menus, flow chart	6
2.3 Explanation of the menus	7
<b>3. Operation</b>	
3.1 Setting up the F610 for different insert sizes	11
3.2 Adjusting the envelope feeder	12
3.3 Loading envelopes	13
3.4 Filling water	13
3.5 Setup a new job	14
3.6 Start inserting	15
<b>4. Added features</b>	
4.1 How to adjust the amount of sealing water	16
4.2 How to select language	16
4.3 Diagnostics	17
<b>5. Maintenance</b>	
5.1 Cleaning the water tray	19
5.2 Cleaning the envelope sealing flap	20
5.3 Cleaning the envelope feed belts	21
5.4 GFI function test and resetting	21
<b>6. Problem solving</b>	
6.1 General problems	22
<b>7. Specifications</b>	
7.1 Model F610 Specifications	26
7.2 Insert and envelope specifications	26

# Introduction

---

## 1. INTRODUCTION

The Model F610 is an inserter that can be used on-line with the Model F612/F615 collator and/or Model F601 booklet feeder or for handfeeding. This User Guide covers the operation of the Model F610 both as a stand-alone unit or connected to the above mentioned collator. For on-line operation with Model F601, also see the Model F601 User Guide.

### 1.1 Safety

#### **General**

- Know your equipment, especially **how to stop it in the event of an emergency**.
- Never reach into the machine while it is on; always wait until the machine has come to a full stop.
- Never touch moving parts.
- Keep fingers, long hair, jewellery and loose clothing away from moving parts at all times.
- Use the equipment only for its intended purpose.
- Don't remove machine covers. Refer servicing to qualified personnel.

#### **Mains Electrical Connection**

In some countries the F610 is supplied with a moulded mains lead. In other countries, or if the supplied lead is not used, the following information applies:

1. An approved mains lead for the country concerned must be used.
2. The wires in the supplied mains lead are coloured in accordance with the following code:

Green and Yellow	-	Earth
Blue	-	Neutral
Brown	-	Live
3. As the colours of the wires in the mains lead of this equipment may not correspond with the coloured markings identifying the terminals in your plug, proceed as follows:

The wire which is coloured green and yellow must be connected to the terminal in the plug which is marked with the letter "E" or by the earth symbol  or coloured green or green and yellow.

The wire which is coloured blue must be connected to the terminal which is marked with the letter "N" or coloured black.

The wire which is coloured brown must be connected to the terminal which is marked with the letter "L" or coloured red.

## 2. GETTING TO KNOW THE F610

The Model F610 is easy to use thanks to a fully microprocessor controlled operation. With the 4 buttons on the control panel you can choose between the different menus shown on the LCD display and do your settings. Take a few minutes to become familiar with components of the F610.

### 2.1 Main components

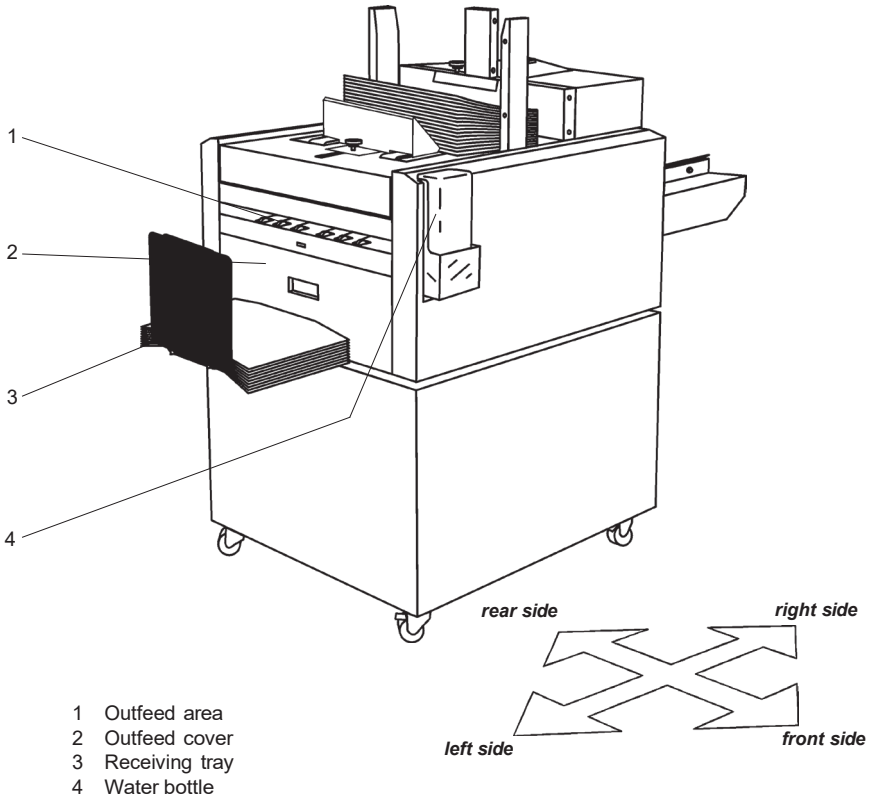

# The Inserter

---

## 2.1 Main components (continued)

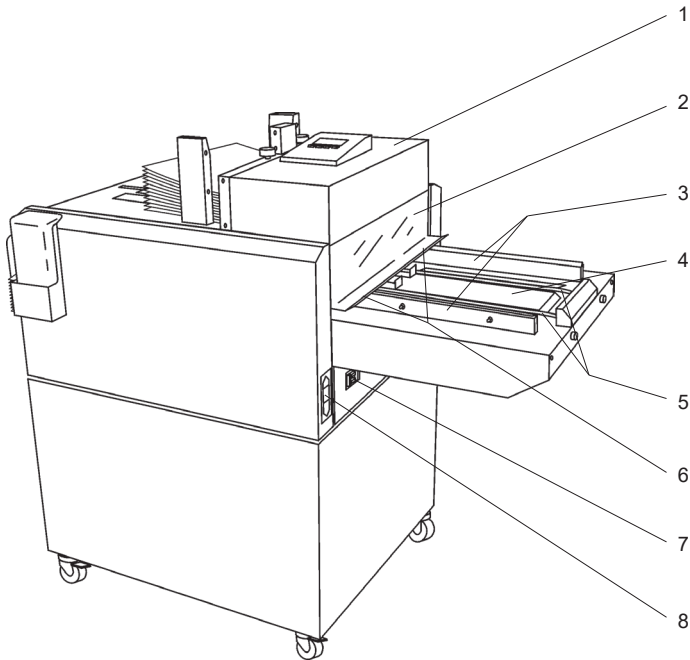

- 1 Envelope feeding cover
- 2 Plastic cover
- 3 Document table side guides
- 4 Document table
- 5 Insert feed belts
- 6 Oversize envelope (B4) adjustment knobs
- 7 Ground fault interrupter (GFI)
- 8 Main power switch, power cord receptacle and main fuse

## 2.1 Main components (continued)

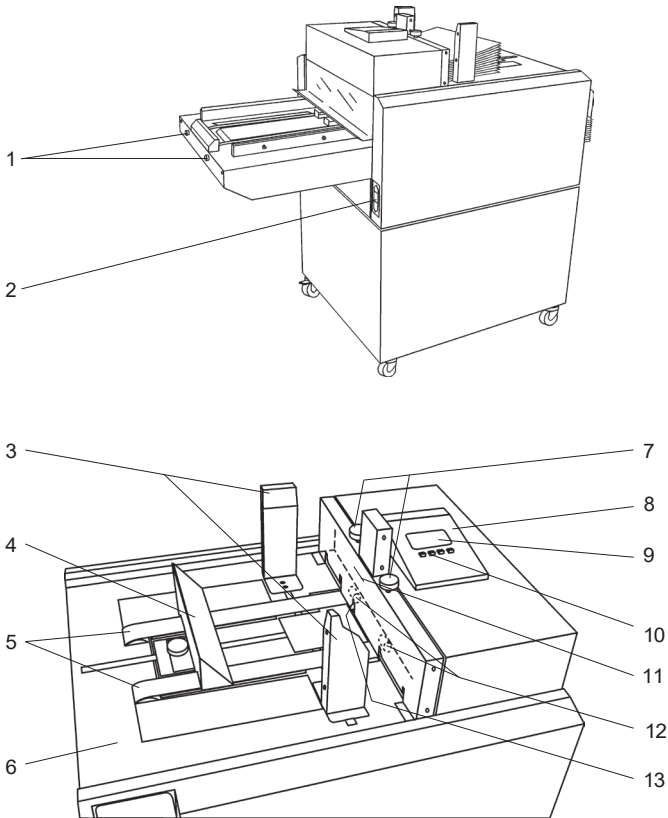

- |   |                        |    |  |
|---|------------------------|----|--|
| 1 | Docking Studs          | 7  | Envelope separator pads adjustment knobs |
| 2 | Connection cable jacks | 8  | Control Panel                            |
| 3 | Envelope side guides   | 9  | LCD display                              |
| 4 | Envelope rear guide    | 10 | Control buttons, multi function          |
| 5 | Envelope feed belts    | 11 | Maximum load mark (red)                  |
| 6 | Envelope feeding table | 12 | Envelope separator pads                  |
|   |                        | 13 | Out of envelope sensor                   |

# The Inserter

## 2.2 The menus, flow chart

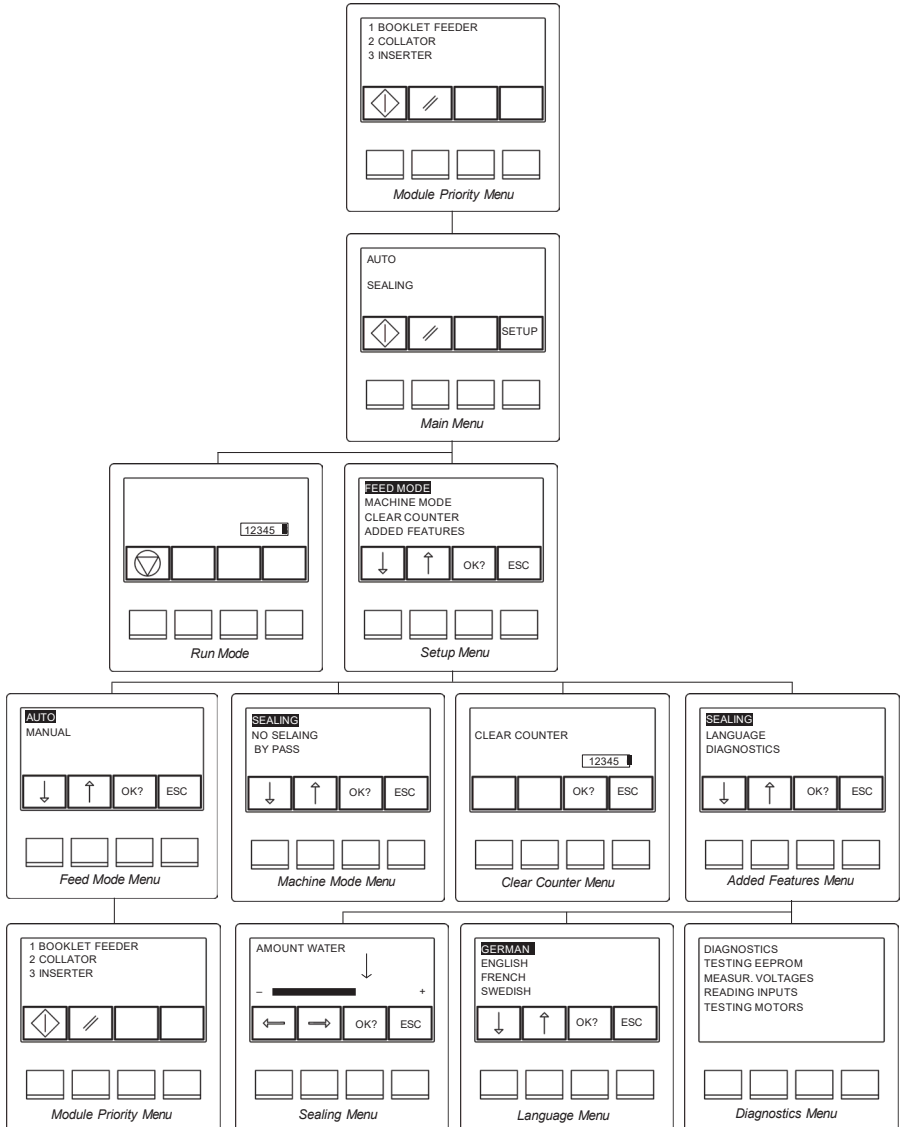

## 2.3 Explanation of the menus

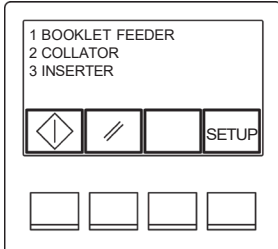

The **Module Priority Menu** appears after switching on the power. This menu shows how the units are electrically connected. Press the right button (“SETUP”) once to enter the **Setup Menu**, and once again (“ESC”) to enter the **Main Menu**.

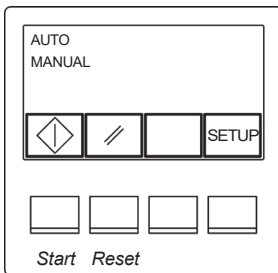

The Main Menu is where you return before starting the job after changing any settings. Use the left button (below the start symbol) to initialize **Run Mode**. The next button is the reset button which allows you to reset the machine i.e. clear the machine from envelopes and inserts. With the right button you can enter the **Setup Menu**.

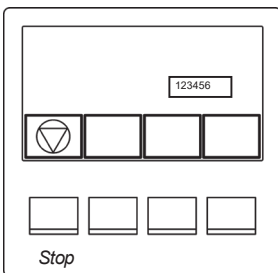

The **Run Mode** indicates that the Model F610 is ready for use. Press the stop button to stop inserting and to return to the **Main Menu**. If manual mode is chosen from the **Feed Mode Menu**, and no inserts are fed to the document table within 15 seconds, the Model F610 will automatically return to the **Main Menu**.

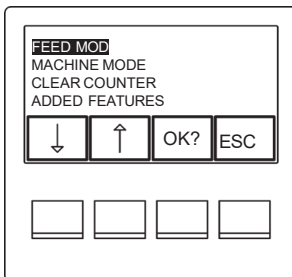

In the **Setup Menu** you can scroll up and down with the buttons below the arrow symbols. The chosen submenu will be shown with the text inverted. Confirm your choice by pressing the “OK?” button.

To return to the **Main Menu** press the “ESC” button.



# The Inserter

## 2.3 Explanation of the menus (continued)

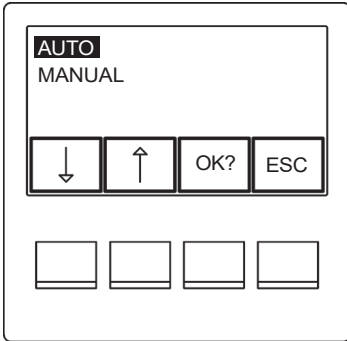

In the **Feed Mode Menu** you can choose between manual feeding or automatic feeding from a collator and/or booklet feeder. The chosen item will be shown with the text inverted. Confirm your choice by pressing the "OK?" button or cancel with the "ESC" button to return to the **Setup Menu**.

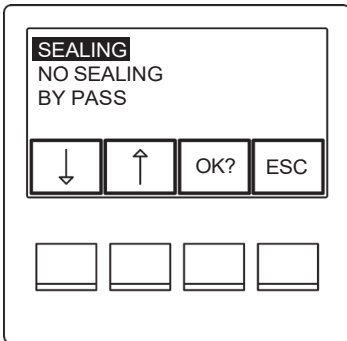

In the **Machine Mode Menu** you can choose between inserting with sealing, inserting and no sealing or just to let the Model F610 feed your inserts through the machine (without any envelopes as a bypass function). The chosen mode will be shown with the text inverted. Confirm your choice by pressing the "OK?" button or cancel with the "ESC" button to return to the **Setup Menu**.

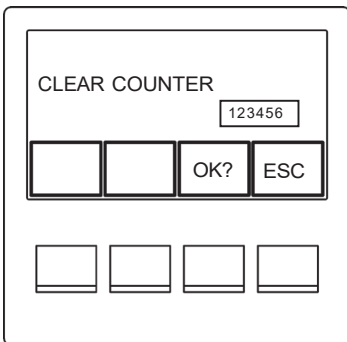

In the **Clear Counter Menu** you can reset the counter. Confirm your choice by pressing the "OK?" button or cancel with the "ESC" button to return to the **Setup Menu**.

## 2.3 Explanation of the menus (continued)

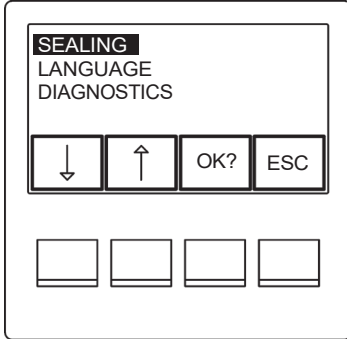

In the **Added Features Menu** you can access the **Water Amount Adjustment Menu**, the **Language Menu** or start the self test program, **Diagnostics**. The chosen item will be shown with the text inverted. Confirm your choice by pressing the "OK?" button or cancel with the "ESC" button to return to the **Setup Menu**.

**NOTE:** Choosing "DIAGNOSTICS" will immediately start the built in self test program. Before performing Diagnostics it is very important to read "4.3 Diagnostics" in the section "4 Added Features".

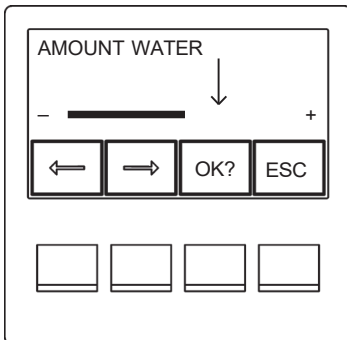

In the **Water Amount Adjustment Menu** you can adjust the amount of sealing water in the wetting system by pressing the corresponding arrow button. The previous setting is indicated by an arrow. Confirm your choice by pressing the "OK?" button or cancel with the "ESC" button to return to the **Added Features Menu**.

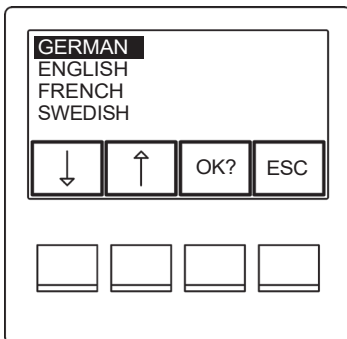

In the **Language Menu** you can scroll/select which language you want to be displayed using the arrow buttons. The chosen language will be shown with the text inverted. Confirm your choice by pressing the "OK?" button or cancel with the "ESC" button to return to the **Added Features Menu**.

# The Inserter

---

## 2.3 Explanation of the menus (continued)

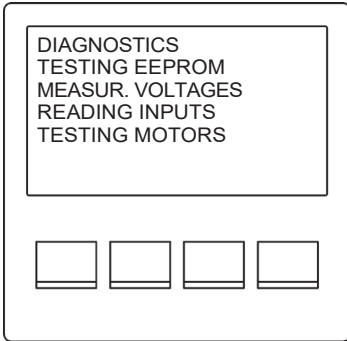

After choosing "DIAGNOSTICS" the display will show what type of self test is currently being performed. During the test you will hear sounds when components are tested.

**NOTE:** Before performing a Diagnostics it is very important to read "4.3 Diagnostics" in the section "4 Added Features".

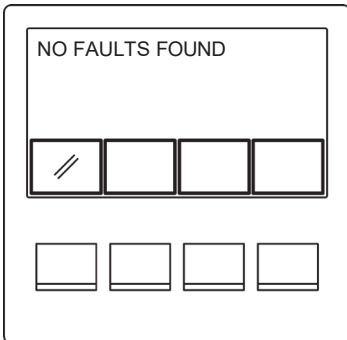

Normally the message "NO FAULTS FOUND" should be displayed. Press the reset button (  ) to return to the **Added Features Menu**.

If the self test program finds any errors, the display will show the faulty component, its actual status and a fault code. If there are multiple errors, there will be an arrow button and a cancel button visible. Scroll with the arrow button and press the "ESC" button to return to the **Added Features Menu**.

## 3. OPERATION

### 3.1 Setting up the F610 for different insert sizes

**CAUTION:** Before adjusting the side guides press the reset button from the Main Menu to avoid damaging the envelope opener.

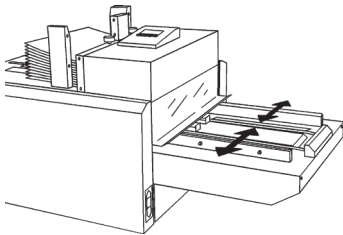

The side guide position determines the position of the envelope openers engaging the envelope. Adjust the document table side guides by sliding them towards or away from each other by gripping the side guides by the blue dots. Adjust them to the scale mark corresponding the insert size. A normal setting allows a 2 to 3mm gap between the inserts and the side guides. If measurement “C” (see section 7.2) is large, a larger gap has to be allowed, otherwise the envelopes will not be opened for insertion.

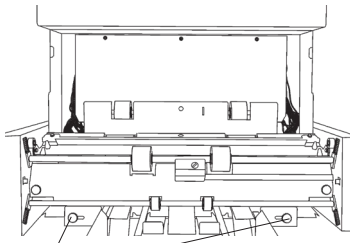

oversize envelope adjustment knobs shown in their outermost position

When B4 envelopes (extra wide) are used to accommodate a large packing thickness, the oversized envelope adjustment knobs should be set to their outermost positions to avoid damage to the envelopes. Loosen the knobs to adjust.

**CAUTION:** Only perform the adjustment when the document table side guides are in their outermost position.

**NOTE:** If B4 envelopes (extra wide) are not being used, the oversized envelope adjustment knobs should be set to their innermost positions.

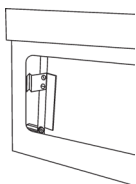

0 - 7 mm position

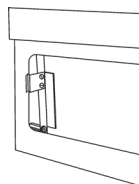

5 - 12 mm position

Depending on the actual packing thickness, the outfeed rollers need to be adjusted. Open the outfeed cover and position the two levers, one on each side, to the required position as shown in the figure. The position also depends on how compressible the envelope with the inserts is, and the envelope texture.

# Operation

## 3.2 Adjusting the envelope feeder

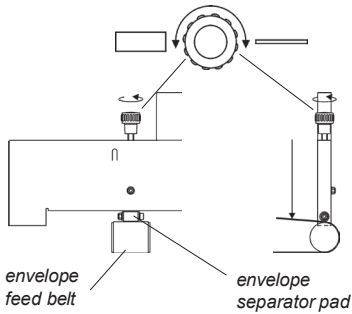

**NOTE:** It is important for envelope feeding that the gap between the envelope separator pads and the envelope feed belts is correct and equal!

### Default setting

Press the envelope feed belt downwards at the arrow and tighten the envelope separation adjustment knob until there is no gap between the separator pad and the feed belt. Then loosen the adjustment knob one and a half turns. To facilitate adjustment, use a flash light and/or a 0.05 mm feeler gauge.

If double feed occurs: Tighten the adjustment knobs.

If misfeed occurs: Loosen the adjustment knobs.

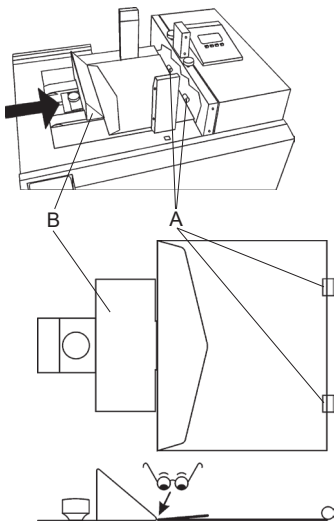

**NOTE:** The friction between the envelopes and the envelope feed belts is also essential for proper envelope feeding. Therefore the rear envelope guide (B) must be adjusted properly.

### Envelopes

Place one envelope on the envelope feeder with its right edge against the envelope separator pads (A). Loosen the knob on the rear envelope guide (B) and slide it so that it is in line with the left edge of the envelope.

### Bags

Place one bag on the envelope feeder so its right edge is against the envelope separator pads (A). Loosen the knob on the rear envelope guide (B) and slide it so that the left edge of the bag reaches the top of the slope.

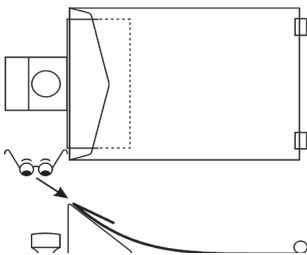

## 3.3 Loading envelopes

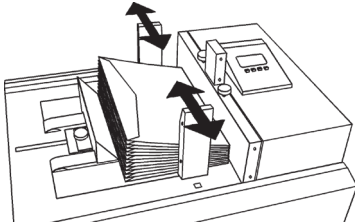

envelope low symbol

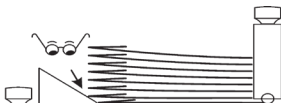
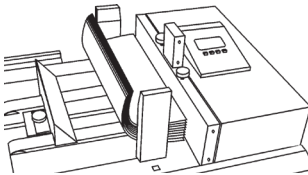

Slide the envelope feeder side guides away from each other. Load the rest of the envelopes, no higher than the red mark, with the flaps up and to the left. Slide the envelope feeder side guides towards each other against the envelopes without squeezing.

The right side of the envelope stack should be straight and make sure the envelope low symbol disappears from the display.

### NOTES:

**Before loading the envelopes, fan them properly to make sure they are not glued together.**

**Also bend the envelopes perpendicular to the feed direction, to make sure the envelopes have proper contact with the envelope feed belts.**

**When running, make sure one or two envelopes fall down to the feed belts and the rest of the stack should lay onto the rear envelope guide. Adjust the rear guide if necessary.**

## 3.4 Filling water

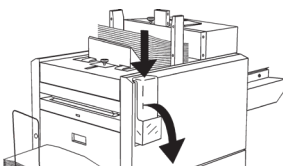

The water bottle is mounted upside down and fills the wetting system through holes in the cap.

Press down the water bottle slightly. Remove the bottle by turning it over and lifting it out. Fill the bottle with fresh water and tighten the cap. Put the bottle back in the same position. Do not pour water directly into the tray.

# Operation

## 3.5 Setup a new job

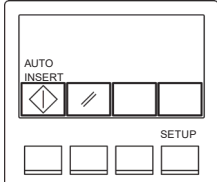

Switch on the power and enter the **Setup Menu**.

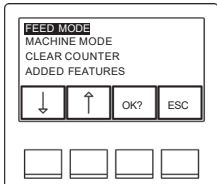

Enter the **Feed Mode Menu**.

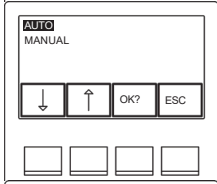

Choose “AUTO” to feed your inserts from a collator and/or a booklet feeder. Follow instructions in the collator and/or booklet feeder operator manual to setup the collator and/or booklet feeder properly. Choose “MANUAL” to feed your inserts manually. Confirm your choice by pressing the “OK?” button.

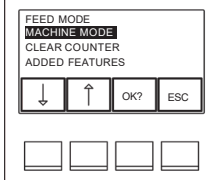

Enter the **Machine Mode Menu**.

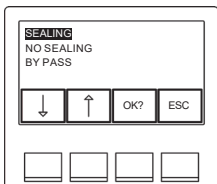

Choose the desired machine mode; “INSERT”, “NO SEALING” or “BY PASS”. Confirm your choice by pressing the “OK?” button

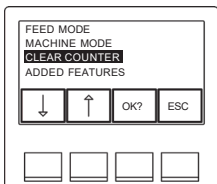

If you wish to clear the counter, choose “CLEAR COUNTER” and confirm by pressing the “OK?” button.

Press the “ESC” button to return to the **Main Menu**.

## 3.6 Start inserting

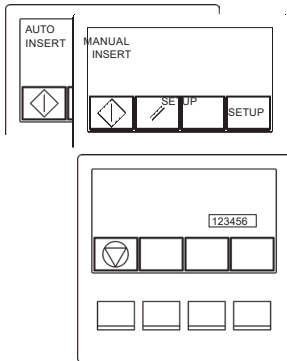

### “AUTO” mode:

If a collator is connected, press the calibration test button on the collator. One set will be fed to the document table and the system will stop. Check that the inserts fed to the document table are correct.

If a booklet feeder is connected, select Single cycle. One insert will be fed from the booklet feeder. Check that the insert was properly fed.

Start the F610 by pressing the start button. Attached on-line units will start as well. The system can also be started by pressing start on any of the other units.

The **Run Mode** indicates that the Model F610 is operating.

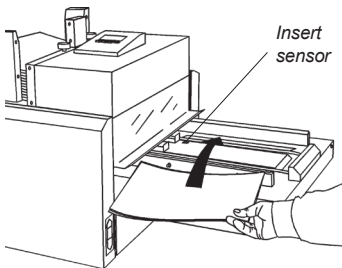

### “MANUAL” mode:

Set the F610 into stand-by mode by pressing the Start button.

Begin inserting by feeding your inserts manually to the document table. Make sure that the inserts block the infeed sensor.

Inserts can be “married together” by choosing “AUTO” mode combined with hand feeding. Reduce the speed on the collator (1000 sets per hour). Feed the document you want to add **before** the inserts are fed from the collator.

To stop inserting, press the stop button on the Model F610.

**CAUTION:** *The insert feed belts will start to travel about 0.7 seconds after the insert sensor is blocked.*

**NOTE:** *If the insert sensor is not blocked within 15 seconds in “MANUAL” mode, the Model F610 will return from run mode to the Main Menu.*



# Features

---

## 4. ADDED FEATURES

### 4.1 How to adjust the amount of sealing water

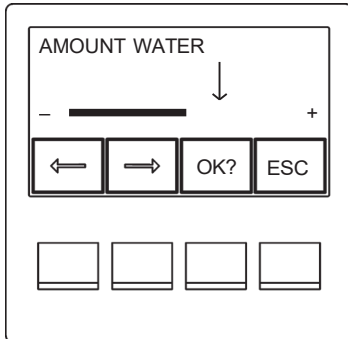

- Enter the **Setup Menu**.
- Enter the **Added Features Menu**.
- Enter the **Sealing Menu**.

Adjust the amount of sealing water by pressing the corresponding arrow button. The previous setting is indicated by an arrow. Confirm your choice by pressing the “OK?” button or cancel with the “ESC” button to return to the **Added Features Menu**.

- Press the “ESC” button to return to the **Setup Menu**.
- Press the “ESC” button to return to the **Main Menu**.

### 4.2 How to select language

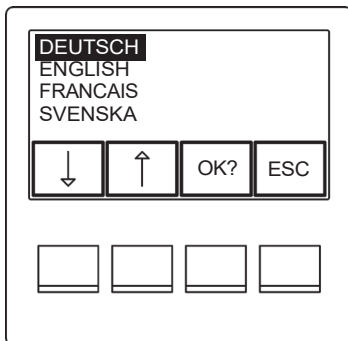

- Enter the **Setup Menu**.
- Enter the **Added Features Menu**.
- Enter the **Language Menu**.

Select language by scrolling with the arrow buttons. The chosen language will be shown with the text inverted. Confirm your choice by pressing the “OK?” button or cancel with the “ESC” button to return to the **Added Features Menu**.

- Press the “ESC” button to return to the **Setup Menu**.
- Press the “ESC” button again to return to the **Main Menu**.

## 4.3 Diagnostics

The Diagnostics is a self test program the operator can run in order to verify the status of the Model F610 if problems are experienced. The self test program will perform a test of the EEPROM, sensors, motors and circuits as well as checking of different voltages.

**NOTE: Choosing “DIAGNOSTICS” will immediately start the self test program. Before performing a Diagnostics it is very important to:**

- Remove all envelopes from the envelope feeding table.
- Remove all inserts from the document table.
- Press the reset button from the Main Menu to clear the Model F610 from envelopes and inserts inside.
- Empty the receiving tray.

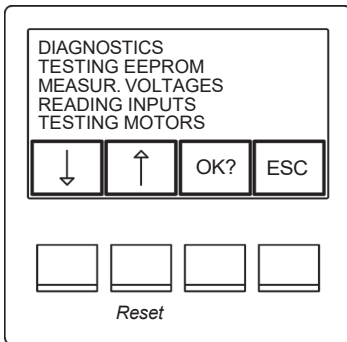

**CAUTION: Do not attempt to stop the self test program before it is finished.**

To start Diagnostics from the **Main Menu**:

- Enter the **Setup Menu**.
- Enter the **Added Features Menu**.
- Choose “DIAGNOSTICS” and press the “OK” button.

After choosing “DIAGNOSTICS” the display will show what type of self test is currently being performed. During the test you will hear sounds when components are tested.

Normally the message “NO FAULTS FOUND” should be displayed. If the self test program finds any errors, the display will show the faulty component, its actual status and a fault code. If there are multiple errors, you can scroll with the arrow button.

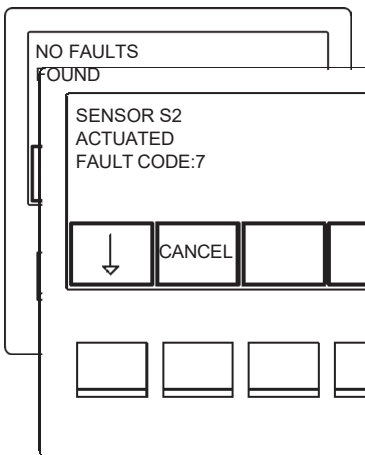

- Press the “ESC” button to return to the **Added Features Menu**.
- Press the “ESC” button to return to the **Setup Menu**.
- Press “ESC” to return to the **Main Menu**.

# Features

---

## 4.3 Diagnostics (continued)

Fault code	Error message	Explanation
1	EEPROM ERROR	The EEPROM is defective.
2	UNR. VOLTAGE LOW	The unregulated voltage supplied to the Model F610 is too low and/or the transformer is defective.
3	UNR. VOLTAGE HIGH	The unregulated voltage supplied to the Model F610 is too high and/or the transformer is defective.
4	REG. VOLTAGE LOW	The regulated voltage is too low.
5	REG. VOLTAGE HIGH	The regulated voltage is too high.
6 - 19	SENSOR S# ACTUATED	Foreign object is covering the mentioned sensor.
20	COVER OPEN	The envelope feeding table is open.
21	INTERLOCK	The interlock switch in the envelope feeding cover is actuated.
22	SENSOR S17 ACTUATED	Water level low.
31 - 49 (odd Nos only)	MOTOR M# OPEN CIRCUIT	Interruption in the specified motor circuit.
32 - 50 (even Nos only)	MOTOR M# SHORT CIRCUIT	Short circuit in the specified motor circuit.
51 - 56	SENSOR S# NOT RESPONDING	Interruption in the specified sensor circuit.
57	INTERLOCK RELAY	Interlock relay defective.

## 5. MAINTENANCE

### 5.1 Cleaning the water tray

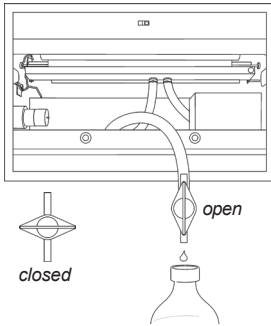

The water tray should be cleaned at least every other week.

- Remove the water bottle.
- Pull out and remove the receiving tray.
- Open and remove the outfeed cover.
- Pull out the hose, open the tap and empty the water tray.
- Close the tap and put the hose back in position.

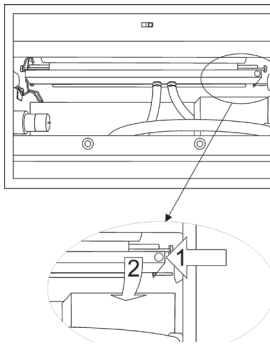

- Unlock the water tray by pushing it to the left and fold it downwards.

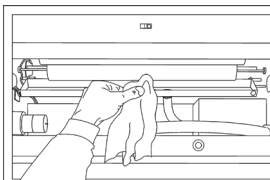

- Clean the water tray.

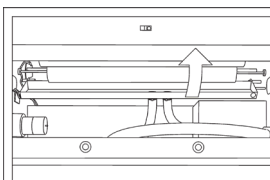

- Hold the guide plate in the correct position (see picture on next page) while folding the water tray upwards until it snaps into locked position.

**Caution: Check that the guide plate behind the water tray is in the correct position. Incorrect position causes sealing jam.**

# Maintenance

## 5.1 Cleaning the water tray (continued)

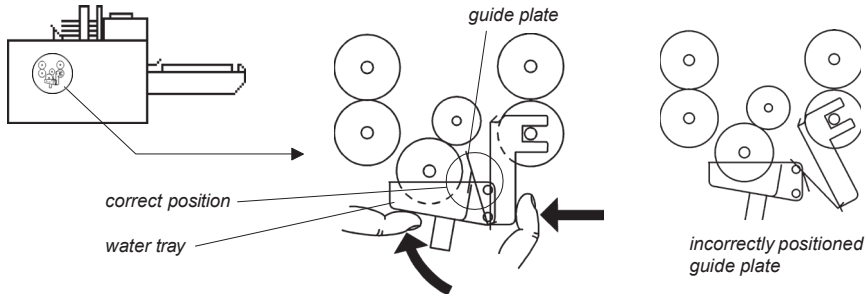

## 5.2 Cleaning the envelope sealing flap

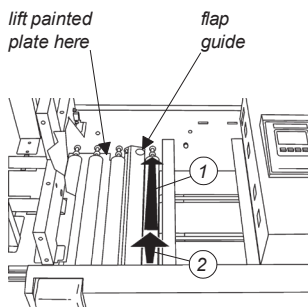

The envelope sealing flap (stainless steel) and a guide plate (stainless steel) under it, as well as the painted plate under the two leftmost rollers, will eventually need cleaning due to glue build-up.

Clean the envelope sealing flap and the guide plate by lifting approximately 10mm at the blue dot. To facilitate cleaning, the rightmost roller can be removed. Press down the envelope sealing flap and remove the roller by pushing it to the rear (1) and lifting the front end (2).

Clean the painted plate under the rollers. If necessary, remove the painted plate by lifting the rightmost edge as shown in the illustration (and same place opposite side). Close the envelope feeding table and pull the plate out towards the receiving tray.

## 5.3 Cleaning the envelope feed belts

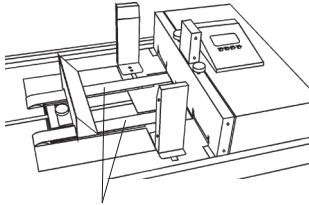

envelope feed belts

Clean the envelope feed belts using a mild soap detergent every 10,000 feeds or when the belts lack friction.

## 5.4 GFI function test and resetting

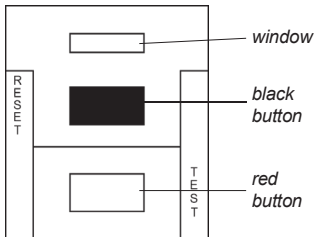

**WARNING: DO NOT use the Model F610 if the following test fails. No additional testing should be performed. Call for service.**

When testing the Ground Fault Interrupter (GFI), the Model F610 power cord must be connected to the wall receptacle and the main power switch in the ON (1) position.

- Press the red "TEST" button.
- Press the black "RESET" button. A red flag should appear in the window of the GFI.
- Press the red "TEST" button. The red flag should disappear.
- Press the black "RESET" button again. The Model F610 should now be ready to use.





# Problems?

## 6. PROBLEM SOLVING

This section explains possible causes and what actions to take if an error message should appear in the display.

Always remove envelopes and inserts in the same direction as they travel through the Model F610. If problem cannot be solved - call for service.

### 6.1 General Problems

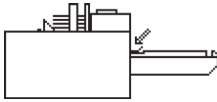
Displayed message/symbol	Explanation/Possible causes	Action
	Water level low.	Fill water as described in section 3.4.
	Stacker full. Stop signal sent to collator and/or booklet feeder (if attached).	Empty the receiving tray.
	Envelope feeder empty. Stop signal sent to collator and/or booklet feeder (if attached).	Load more envelopes.
 ENVELOPE MISS	Envelope could not be fed from envelope feeder. Envelope miss occurs when the envelopes do not have proper contact with the envelope feed belts (i.e. when the friction is too low).	<ol style="list-style-type: none"> <li>1. Check that the envelopes are bent as described in section 3.3.</li> <li>2. Check adjustment of the envelope separation pads (see section 3.2).</li> <li>3. Check the adjustment of the envelope rear guide (see section 3.2). Check/clean the feed belts (see section 5.3).</li> </ol>
 INTERLOCK	The interlock switch in the plastic cover is actuated.	<ol style="list-style-type: none"> <li>1. Remove obstacle. If necessary slide the envelope feeding table open and open the envelope feeding cover.</li> <li>2. After obstacle is removed, follow on screen instruction.</li> </ol>



**NOTE:** These symbols can appear although the action above may not be necessary. For instance, an air bubble in the water hose could cause the water level symbol to appear intermittently. Once the air bubble disappears, the water level warning symbol extinguishes automatically. If the problem persists for a certain amount of time, the machine stops.

This means that when attending a stopped machine, the fault message may already have been corrected.

## 6.1 General Problems (continued)

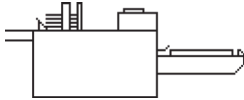
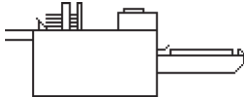
Displayed message/symbol	Explanation/Possible causes	Action
INTERLOCK RESET SYSTEM	The interlock switch in the plastic cover was actuated but obstacle is no longer actuating the interlock switch.	Press the reset button. Press the start button. Start the collator (if attached).
THE TOP COVER IS OPEN	The envelope feeding table is open.	Close the envelope feeding table.
 FLAP OPENER MISS	<ol style="list-style-type: none"> <li>1. The flap on the envelope could not be opened when the envelope was positioned before inserting.</li> <li>2. The flap on the envelope was already open when the envelope was fed.</li> </ol>	Slide the envelope feeding table open. Remove the envelope. Close the envelope feeding table. Press the reset button. <ol style="list-style-type: none"> <li>1. Check that the envelopes are loaded with the flap up, closed and towards the envelope rear guide as described in section 3.3.</li> <li>2. Check that the envelopes are not already sealed accidentally.</li> <li>3. Check that the flap not is too heavily curved. Press the start button. Start the collator (if attached).</li> </ol>
 SEALING JAM	Malfunction when sealing.	Slide the envelope feeding table open. Remove the envelope. Close the envelope feeding table. Press the reset button. <ol style="list-style-type: none"> <li>1. Check/fill water as described in section 3.4.</li> <li>2. Check that the guide plate is in the correct position as described in section 5.1.</li> <li>3. Check/clean as described in sections 5.1 and 5.2.</li> </ol> Press the start button. Start the collator (if attached). <ol style="list-style-type: none"> <li>4. Check that the outfeed roller level is set correctly (see section 3.1).</li> <li>5. Check that the springs are in the correct position as described in section 3.1.</li> </ol>



# Problems?

## 6.1 General Problems (continued)

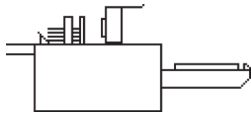
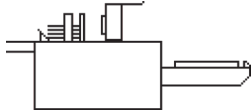
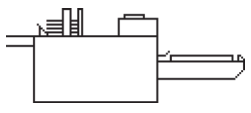
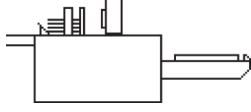
Displayed message/symbol	Explanation/Possible causes	Action
 <p>INSERTER ERROR</p>	Malfunction when inserting.	Clear the document table. Slide the envelope feeding table open. Remove envelope and inserts. Close the envelope feeding table. Press the reset button. Check the adjustment of the document table side guides as described in section 3.1. If the inserts are close to minimum recommended specifications for actual envelope size (see section 7.2) you might have to exceed the recommended play of 2 to 3 mm. Press the start button.
 <p>FEED ERROR</p>	Envelope jam under the envelope feeding cover.	Slide the envelope feeding table open. Open the envelope feeding cover. Remove the envelope. Close the envelope feeding cover. Close the envelope feeding table. Press the reset button. Press the start button.
 <p>REMOVE PAPER</p>	Insert(s) or envelope inside the machine.	Slide the envelope feeding table open. Remove envelope and inserts. Close the envelope feeding table. Press the reset button. If problem continues, check that the envelopes fed not are too heavily curved.
 <p>REMOVE ENVELOPE</p>	<ol style="list-style-type: none"> <li>1. Envelope is not removed after a feed error.</li> <li>2. Double feeding of envelopes.</li> </ol>	Slide the envelope feeding table open. Open the envelope feeding cover. Remove the envelope. Close the envelope feeding cover. Close the envelope feeding table. Press the reset button. Press the start button.
<p>FEEDER JAM</p>	Jam in unit feeding Model F610.	Follow unit's User Guide to clear jam. Press the reset button. Press the start button.

## 7. SPECIFICATIONS

### 7.1 Model F610 Specifications

SPECIFICATIONS	MODEL F610
Envelope size	Min. See next page Max. See next page
Envelope loading capacity	100 mm
Paper size	Min. See next page Max. See next page
Paper weight (insert)	Min. 60 gsm Max. 600g insert total weight
Maximum speed	Up to 3600 envelopes/hour
Envelope weight (substance)	80 gsm to 120 gsm
Max collation thickness	12 mm
Misfeed detection	Yes
Jam detection	Yes
Envelope low detection	Yes
Stacker full detection	Yes
Height	560 mm
Width	1150 mm
Depth	640 mm
Weight	83 kg
Voltage	230/240 volt, 50 Hz

**NOTE:**

A4/A5 sizes of material CANNOT be processed automatically from the booklet feeder/collator in one operation.

# Specifications

## 7.2 Insert and envelope specifications

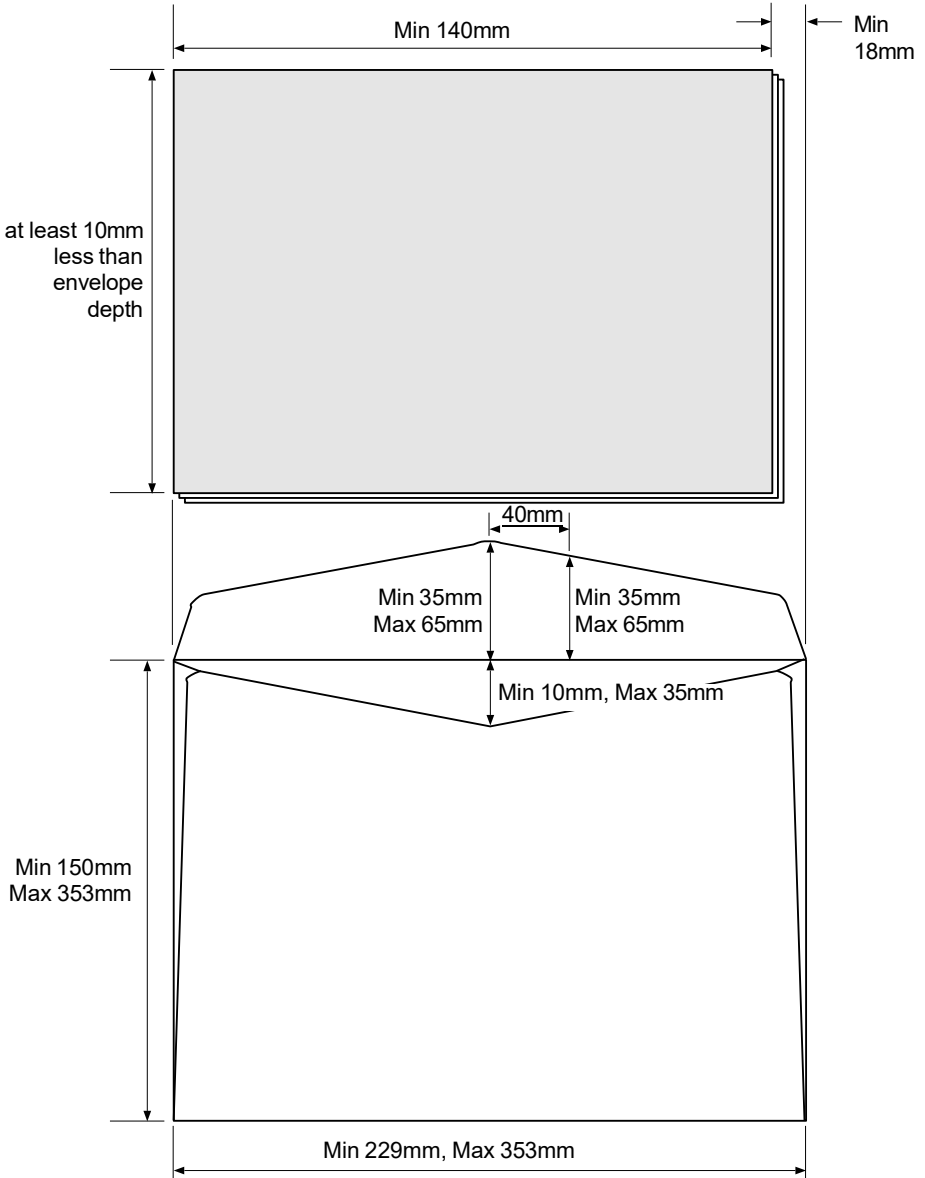

# Specifications

## 7.2 Insert and envelope specifications (continued)

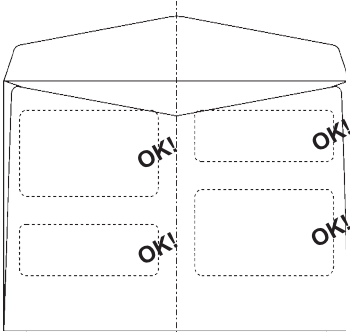

*mailpoint or pointed type flap with window positioned off centre of envelope*

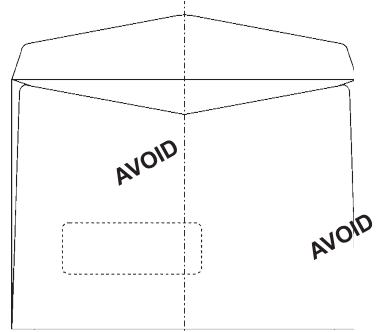

*mailpoint or pointed type flap with window positioned across centre of envelope*

The envelopes should have edge-tight gluing on windows to avoid jams and inserts getting caught between the edge of the patch and the window. Use envelopes where the window is positioned off centre of the envelope to avoid the pointed part of the flap getting caught in the window.

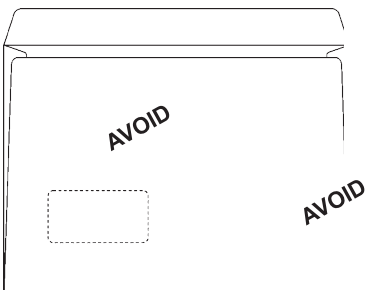

*wallet or square type flap*

Avoid using envelopes with square types of flaps, the straight edge of the flap could easily get caught in the window.

### **NOTE:**

Although within the specification for the system, 'Pocket' style envelopes are not recommended.

Should it be necessary, 'Centre Seam' Pocket envelopes are the best option.

# Notes

---

We have made every reasonable effort to assure the accuracy and usefulness of this guide, however we cannot assume responsibility for errors or omissions or liability for the misuse or misapplication of our products.

**FOR SERVICE AND SUPPLIES:**



**Pitney Bowes**

3001 Summer Street, Stamford,  
Connecticut 06926  
[www.pitneybowes.com](http://www.pitneybowes.com)