

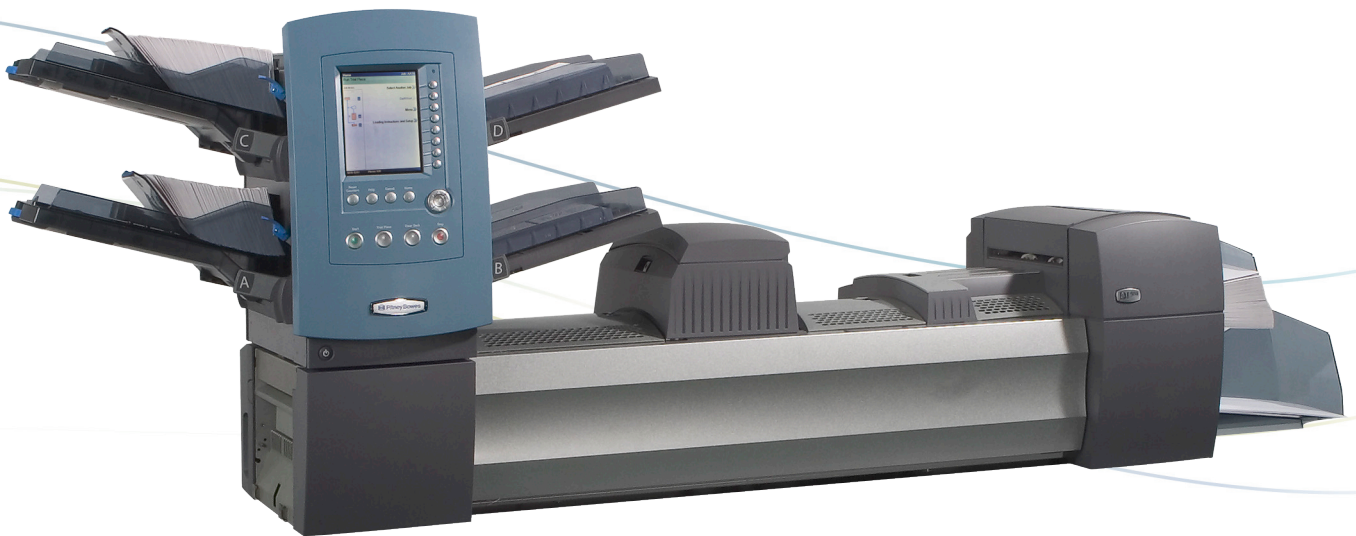

DI900/DI950 FastPac™ Document Inserting System



Operator Guide

US/Canada English Version

Statement of FCC Compliance

This equipment has been tested and found to comply with the limits for a Class A digital device, pursuant to part 15 of the FCC rules. These limits are designed to provide reasonable protection against interference when the equipment is operated in a commercial environment. This equipment generates, uses, and can radiate radio frequency energy and, if not installed and used in accordance with the instruction manual, may cause interference to radio communications. Operation of this equipment in a residential area is likely to cause interference, in which case the user will be required to correct the interference at his own expense.

CAUTION: Changes or modifications to this equipment not expressly approved by the party responsible for compliance (Pitney Bowes) could void the user's authority to operate the equipment.

Canada

This class A digital apparatus complies with Canadian ICES-003.

Cet appareil numérique de la classe A est conforme à la norme NMB-003 du Canada.

SV61311 Rev. E ©2006 Pitney Bowes Inc.

All rights reserved. This book may not be reproduced in whole or in part in any fashion or stored in a retrieval system of any type or transmitted by any means, electronically or mechanically, without the express, written permission of Pitney Bowes. We have made every reasonable effort to ensure the accuracy and usefulness of this manual; however, we cannot assume responsibility for errors or omissions or liability for the misuse or misapplication of our products.

Due to our continuing program of product improvement, equipment and material specifications as well as performance features are subject to change without notice. DM Series, DM800i, DM1000, SwiftStart, SureTrac, Optiflow, IntelliLink and E-Z Seal are trademarks or registered trademarks of Pitney Bowes. Tyvek is a registered trademark of Dupont.

Table of Contents

Contact Information List

USA Contacts	v
Canada Contacts	v

1 • Introduction

A Note to the Operator	1-2
Viewing this Guide as a PDF File	1-2
About Your System	1-3
Standard Systems	1-4
System Options*	1-5
Safety Information.....	1-6
Warning Labels	1-7
Book Contents	1-8

2 • Meet the Inserting System

System Components	2-2
Feeder Tower	2-4
Feeder Trays.....	2-5
Sheet Trays.....	2-5
Insert Trays	2-6
Manual Feeder.....	2-7
Transport Deck	2-8
Mail Piece Path.....	2-8
Pre-fold Accumulator	2-8
Folder.....	2-9
Post-fold Accumulator	2-9
Insertion Area.....	2-9
Folder Bypass Path	2-9
Moistener, Closer, Sealer.....	2-9
About the Control Panel.....	2-10
Screen Option Keys.....	2-10
Fixed Function Keys	2-11
Machine Action Keys	2-13
Screen Navigation Keys	2-13
Display Screen.....	2-14
Header Area.....	2-14
Status Area	2-15
Access Rights	2-20
Logging In	2-21
Logging Out	2-21

Table of Contents

About System Covers	2-22
Opening the Covers	2-23
Closing the Covers	2-23
About the Paper Release Knobs/Levers.....	2-24
About Add-On Modules.....	2-24

3 • Basic Operation

Connecting to Power	3-2
Powering Up	3-2
Home Screen.....	3-3
Job Overview	3-4
Selecting the Job	3-5
Setting Up Feeders and Loading Materials	3-6
Attaching Trays to the Feeder Tower	3-6
Removing Trays from the Feeder Tower.....	3-7
Loading Material into the Trays.....	3-8
Loading the DI950 High Capacity Envelope Feeder (HCEF).....	3-13
Making Pre-Run Adjustments	3-18
Adjusting the Envelope Openers	3-18
Running a Trial Piece.....	3-22
Reviewing the Job Settings	3-24
Starting the Job.....	3-25
SwiftStart™ Jobs	3-25
Using SwiftStart™	3-26
Creating a Job	3-26
Job Options.....	3-30
Envelope Options	3-30
Fold Options	3-32
Sheet Options	3-33
Insert Options	3-36
Editing a Job	3-39
Modifying Job Settings.....	3-40
Editing an Item.....	3-40
Adding an Item.....	3-41
Moving an Item	3-43
Deleting an Item.....	3-44

4 • Advanced Operation

Overview.....	4-2
Using the Alphanumeric Matrix.....	4-2

Saving a Job	4-3
Deleting a Job.....	4-4
Assigning User IDs and Passwords.....	4-5
Enabling and Disabling the High Capacity Sheet Feeder (HCSF).....	4-5

5 • Troubleshooting and Maintenance

Adjusting Screen Brightness and Contrast.....	5-2
Setting the Time and/or Date	5-3
Changing the Language	5-4
Refilling the Sealing Solution	5-5
Handling Material Stoppages.....	5-5
Clearing a Stoppage	5-5
Resuming the Job	5-6
Handling Outsourced Material	5-6
Troubleshooting Tables.....	5-7
Routine Maintenance.....	5-16
Daily Tasks.....	5-16
Replacing the Moistener Wick	5-16
Replacing the Moistener Brushes.....	5-18

6 • Reference

Overview.....	6-2
System Specifications.....	6-2
Component Specifications	6-4
Feeder Tower and Base Material Specifications.....	6-7
General Information	6-7
Outer Envelopes	6-7
Inserts	6-10
Sheets.....	6-11
High Capacity Sheet Feeder (HCSF) Material Specifications ..	6-12
General Information	6-12
Sheets.....	6-12
Materials Not Certified for Use.....	6-13

7 • Add-On Modules

About the Add-On Modules.....	7-2
High Capacity Sheet Feeder (HCSF)	7-2
Loading the HCSF	7-3
Adjusting the HCSF Guides	7-5
Flats Sealer.....	7-7
Replacing the Envelope Edge Marker Roller.....	7-8

Table of Contents

Attached Printer	7-9
Loading the Attached Printer	7-10
Adjusting the Printer Interface Guides	7-11
Printing a Cover Sheet to the Top of the Attached Printer ..	7-13
SureTrac™ Process Verification System	7-13
Exit Options	7-15
DM Series™ Mailing System Interface (DM800i™ or DM1000™ only)	7-15
OptiFlow™ Vertical Power Stacker	7-18
OptiFlow™ Belt Stacker	7-18
Exit Transport.....	7-18

8 • Scanning

Scanning Overview	8-2
OMR	8-2
BCR	8-2
Scanning Features.....	8-4
Setting Up a New Scan Configuration	8-6
Setting Up an OMR Scan Configuration	8-6
Setting Up a BCR Scan Configuration.....	8-9
Editing a Scan Configuration	8-13
Editing an OMR Scan Configuration.....	8-13
Editing a BCR Scan Configuration.....	8-14
Copying a Scan Configuration	8-15
Deleting a Scan Configuration	8-15
Reviewing a Scan Configuration.....	8-16
Viewing the Job List.....	8-16
Assigning a Scan Configuration to an Existing Job	8-17
Adjusting the Scan Heads	8-19
Adjusting the Scan Heads for Ladder Orientation Marks....	8-19
OMR Specifications	8-24
Barcode Specifications	8-26
Setting the OMR Scanning Area.....	8-29
Defining the First Mark Position and Code Length	8-29
Defining the Clear Zone.....	8-30
Additional Information	8-31
BCR and OMR Mark Levels	8-31
Basic Level	8-32
Enhanced Integrity Level	8-34
Selective Operations Level	8-35

Appendix A • Glossary

Basic TermsA-2
 Material References.....A-2
 Machine Functions.....A-3
Icon Glossary.....A-4
 Envelope IconsA-4
 Fold IconsA-5
 Sheet Icons.....A-5
 Insert IconsA-6
 Feeder Assignment IconsA-7
 Other IconsA-7

Index

Index I-1

Table of Contents

This page is intentionally blank.

Contact Information List

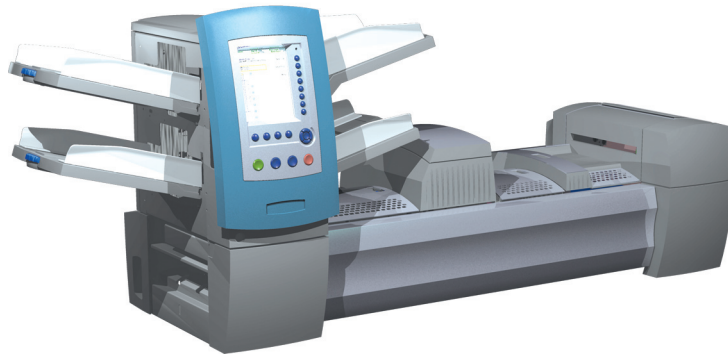

USA Contacts

Product Name - DI900 or DI950

- For frequently asked questions, go to: www.pb.com and click on **Customer Support**.
- To place requests for service or training, go to: www.pb.com and click on **My Account**.
- To order supplies and accessories, call the Supply Line™ at: 1.800.243.7824 or go to: www.pb.com and click on **Online Store**.
- To view and pay invoices online, go to: www.pb.com and click on **My Account**.
- To view inventory, go to: www.pb.com and click on **My Account**.
- For direct questions, call: 1.800.522.0020. Customer Service Representatives are available Monday through Friday, 8:00 AM - 8:00 PM ET.
- To obtain Material Safety Data Sheets, call the Supply Line™ or go to: www.pb.com and click on **Customer Support**.

Canada Contacts

Product Name - DI900 or DI950

- For frequently asked questions or to order supplies, go to: www.pitneybowes.ca
- For direct questions, call: 1.800.672.6937. Customer Service Representatives are available Monday through Friday, 8:30 AM - 4:00 PM ET.

Contact Information List

This page is intentionally blank.

1 • Introduction



A Note to the Operator.....	1-2
Viewing this Guide as a PDF File	1-2
About Your System	1-3
Standard Systems	1-4
System Options	1-5
Safety Information	1-6
Warning Labels.....	1-7
Book Contents.....	1-8

1 • Introduction

A Note to the Operator

It is important to be familiar with this guide as it will enable you to utilize the system to its full potential, while keeping problems to a minimum.

Viewing this Guide as a PDF File

There are several built-in features you can use to navigate through this guide when viewing it as a pdf file:

- Topics highlighted by a blue rectangle are hyperlinks.
Using the Hand tool () , you can click anywhere within a hyperlink to jump to the topic's location in the Help guide.

• To reduce the risk of fire or electrical shock, DO NOT attempt to remove covers or disassemble the control panel or its base. The cabinet closes hazardous parts. If you should damage the unit, contact Peter Bowes. Refer to the [Contact Information List](#) at the front of this guide for more information.

Highlighted Hyperlink

- Entries in the main Table of Contents and the table of contents at the beginning of every chapter are hyperlinks, although they are not highlighted.

Move the Hand tool over a table of contents entry until it points, then click to jump to the location of the entry in the Help guide.

Creating a New Job	3-39
Refilling the Sealer Fluid	3-40
Paper Stoppages	3-40
Clearing a Stoppage	3-40
Resuming the Job	3-41

Table of Contents Hyperlink

- Page numbers in the Index are hyperlinks, although they are not highlighted.

Move the Hand tool over the page number until it points, then click on the page number to jump to that page of the Help guide.

F
Fan 1-9
Feeder Tower 1-3, 2-4
Feeder Trays 1-3, 2-5
insert 2-6
sheet 2-5

Index Hyperlink

About Your System

DI900/DI950 are high throughput, mail creation systems designed to handle a broad range of applications with minimum operator setup adjustments. These systems have the ability to feed, fold, and insert mail piece components into an outer envelope. The systems generate Letters or Flats as the final mail piece. The systems also accept a variety of options that provide a wide range of capacities and operating speeds.



Figure 1.1: The DI900 System

The systems can be configured with four flexible Feeder Trays. There are two types of Feeder Trays:

- Sheet Trays, which are capable of feeding sheets; and
- Insert Trays, which are capable of feeding slip/insert materials, pre-folded inserts, thin booklets, and envelopes.

In addition, the DI950 system is equipped with a dedicated High Capacity Envelope Feeder (HCEF) that allows for greater speed and throughput. The systems also accept material from optional upstream input devices, such as High Capacity Sheet Feeders, Attached Printer, and other devices.

Basic system features are summarized in this chapter. Refer to *Chapter 6* for detailed equipment and material specifications.

The systems are configured with two major components:

- Feeder Tower, and
- Transport Deck.

The Feeder Tower sends material from the Feeder Trays to the Transport Deck. Depending on the job parameters, the material may or may not need to pass through the Folder in the Transport Deck. If it does, the system offers numerous types of folds and the ability to insert the folded material into the appropriate position in the mail piece collation. The system can also seal the envelope (Letter only) before sending the final mail piece to a stacking unit.

1 • Introduction

Standard Systems

DI950C

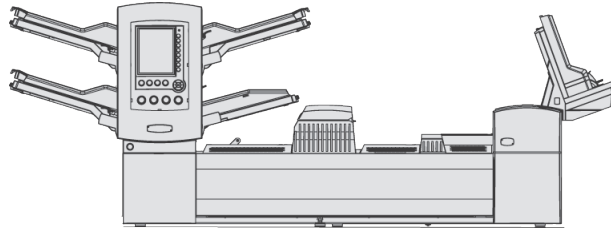

DI950H

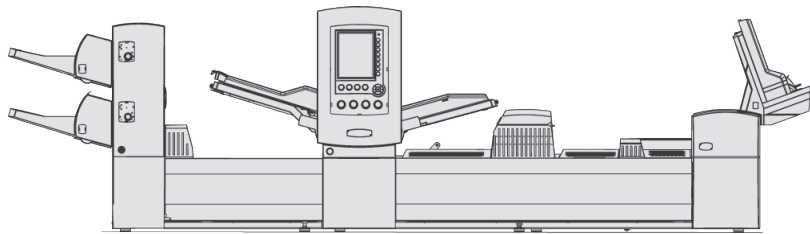

DI900C

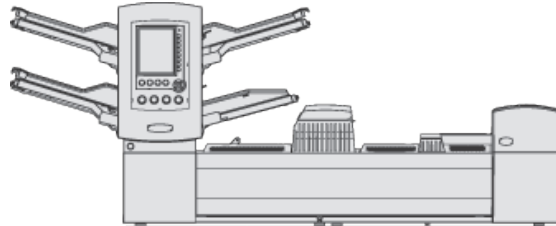

DI900H

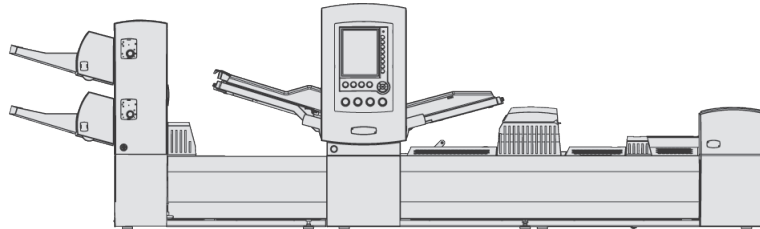

**Letter and Flats Drop Stacker
(standard on all systems)**

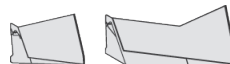

System Options*

**Furniture, designed specifically for the system, is also available.*

Fold Expansion Kit (Document Inverter)

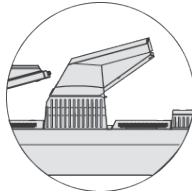

High Capacity Sheet Feeder (HCSF)

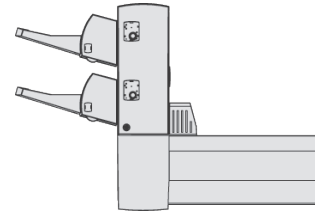

OptiFlow™ Vertical Power Stacker

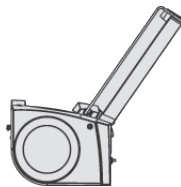

DM Series™ Mailing System DM800i™, DM1000™

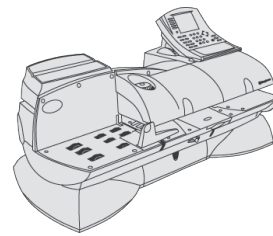

Tandem Belt Stacker

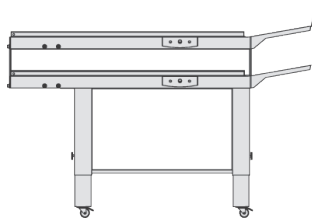

Belt Stacker

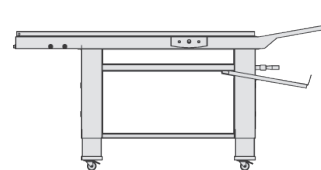

Exit Transport

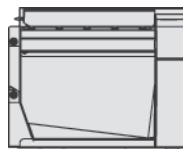

Flats Sealer



Attached Printer

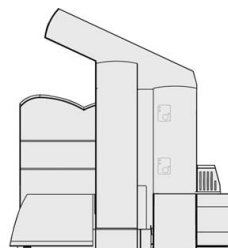

Safety Information

Follow these precautions whenever you use your inserting system:

- Read all instructions before you attempt to operate the system. Keep the Operator Guide accessible for quick reference.
- Use this equipment only for its intended purpose.
- Place the system close to an easily accessible wall outlet.
- Place the system in an accessible location to allow for proper venting of the equipment and to facilitate servicing.
- Use the power cord supplied with the machine and plug it into a properly grounded wall outlet that is located near the machine and easily accessible. Failure to properly ground the machine can result in severe personal injury and/or fire.
- The power cord wall plug is the primary means of disconnecting the machine from the AC supply.
- DO NOT use a wall outlet controlled by a wall switch or one that is shared with other equipment.
- DO NOT use an adapter plug on the line cord or wall outlet.
- DO NOT remove the ground pin from the line cord.
- Make sure the area in front of the wall outlet into which the machine is plugged is free from obstruction.
- DO NOT route the power cord over sharp edges or trap it between pieces of furniture. Make sure there is no strain on the power cord.
- To reduce the risk of fire or electrical shock, DO NOT attempt to remove covers or disassemble the control panel or its base. The cabinet encloses hazardous parts. If you should damage the unit, contact Your system supplier. Refer to the *Contact Information List* at the front of this guide for more information.
- If the unit becomes damaged, unplug it from the wall, then contact Your system supplier. Refer to the *Contact Information List* at the front of this guide for more information.
- Keep fingers, long hair, jewelry and loose clothing away from moving parts at all times.
- Avoid touching moving parts or materials while the machine is in use. Before clearing a jam, be sure machine mechanisms come to a complete stop.
- Remove jammed material gently and carefully.
- Do not place lighted candles, cigarettes, cigars, etc., on the system.
- To prevent overheating, do not cover vent openings.
- Use only approved supplies, in particular aerosol duster. Improper storage and use of aerosol dusters or flammable aerosol dusters, can cause an explosive-like condition that could result in a personal injury and/or property damage. Never use aerosol dusters labeled flammable and always read instructions and safety precautions on the duster container label.

Safety Information (continued)

- To obtain supplies and/or Material Safety Data Sheets, contact your system supplier. Refer to the *Contact Information List* at the front of this guide for more information.
- Operation of this equipment without periodic maintenance will inhibit optimum operating performance and could cause the equipment to malfunction. Contact your system supplier for the required service schedule.
- Always follow specific occupational safety and health standards for your workplace.
- To reduce the risk of fire or electrical shock, DO NOT attempt to remove covers or disassemble the control panel or its base. The cabinet encloses hazardous parts. If you should damage the unit, contact your system supplier. Refer to the *Contact Information List* at the front of this guide for more information.

If your stacker has an AC adapter to power the stacker:

- Use only the AC adapter designed specifically for the stacker. Third-party AC adapters may damage the stacker.
- To protect against electrical shock, plug the AC adapter power cord into a properly grounded wall outlet.
- Do not route the AC adapter cable over sharp edges or trap it between furniture.

Warning Labels

The following warning labels are attached to modules on the system to alert you to potential injury that could occur with careless operating procedures. These same labels will be shown throughout the manual as they apply to the various modules that are discussed in that section.

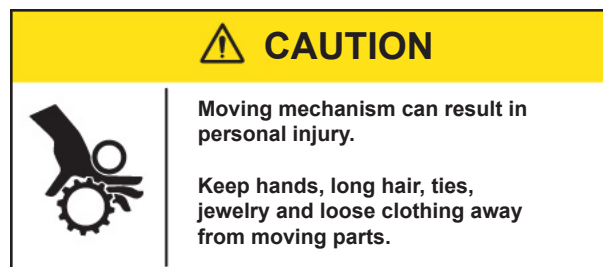

Book Contents

This remaining chapters in this book contain setup, operation, troubleshooting and reference information about your document inserting system.

- *Chapter 2, Meet the Inserting System* - orients you to system software and hardware components.
- *Chapter 3, Basic Operation* - explains basic steps for running a job.
- *Chapter 4, Advanced Operation* - describes advanced procedures.
- *Chapter 5, Troubleshooting* - explains screen adjustment procedures, lists errors and their corrective actions, and describes routine maintenance procedures.
- *Chapter 6, Reference* - lists system specifications.
- *Chapter 7, Add-On Modules* - provides a brief description of each add-on module.
- *Chapter 8, Scanning* - explains scanning options.
- *Appendix A, Glossary* - contains definitions for commonly used terms, and explanations of the icons you'll see on the display screen.

NOTE: Machine Keys will appear in all capital letters. Option Keys will appear in Initial Caps in quotes ("). Variables within options will appear in quotes (") and in the same case as shown on the screen.

2 • Meet the Inserting System

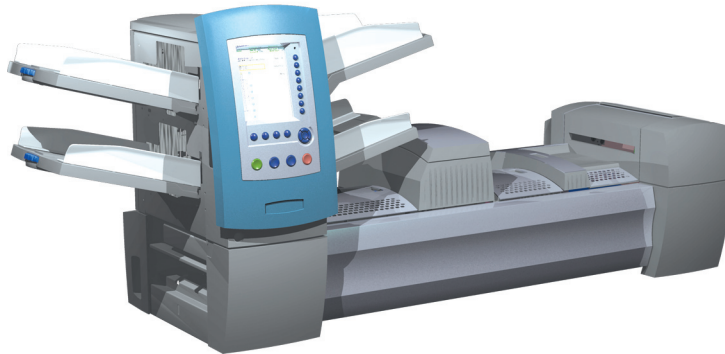

System Components	2-2
Feeder Tower.....	2-4
Feeder Trays	2-5
Sheet Trays	2-5
Insert Trays.....	2-6
Manual Feeder	2-7
Transport Deck.....	2-8
Mail Piece Path.....	2-8
Pre-fold Accumulator	2-8
Folder	2-9
Post-fold Accumulator	2-9
Insertion Area	2-9
Folder Bypass Path	2-9
Moistener, Closer, Sealer	2-9
About the Control Panel	2-10
Screen Option Keys.....	2-10
Fixed Function Keys	2-11
Machine Action Keys	2-13
Screen Navigation Keys	2-13
Display Screen	2-14
Header Area	2-14
Status Area	2-15
Access Rights.....	2-20
Logging In.....	2-21
Logging Out.....	2-21
About System Covers.....	2-22
Opening the Covers.....	2-23
Closing the Covers	2-23
About the Paper Release Knobs/Levers	2-24
About Add-On Modules	2-24

2 • Meet the Inserting System

System Components

The base system configuration includes a Feeder Tower, Transport Deck, and Envelope Sealer; the DI950 features an additional integrated High Capacity Envelope Feeder. Additional modules can be added to utilize the full potential of the system.

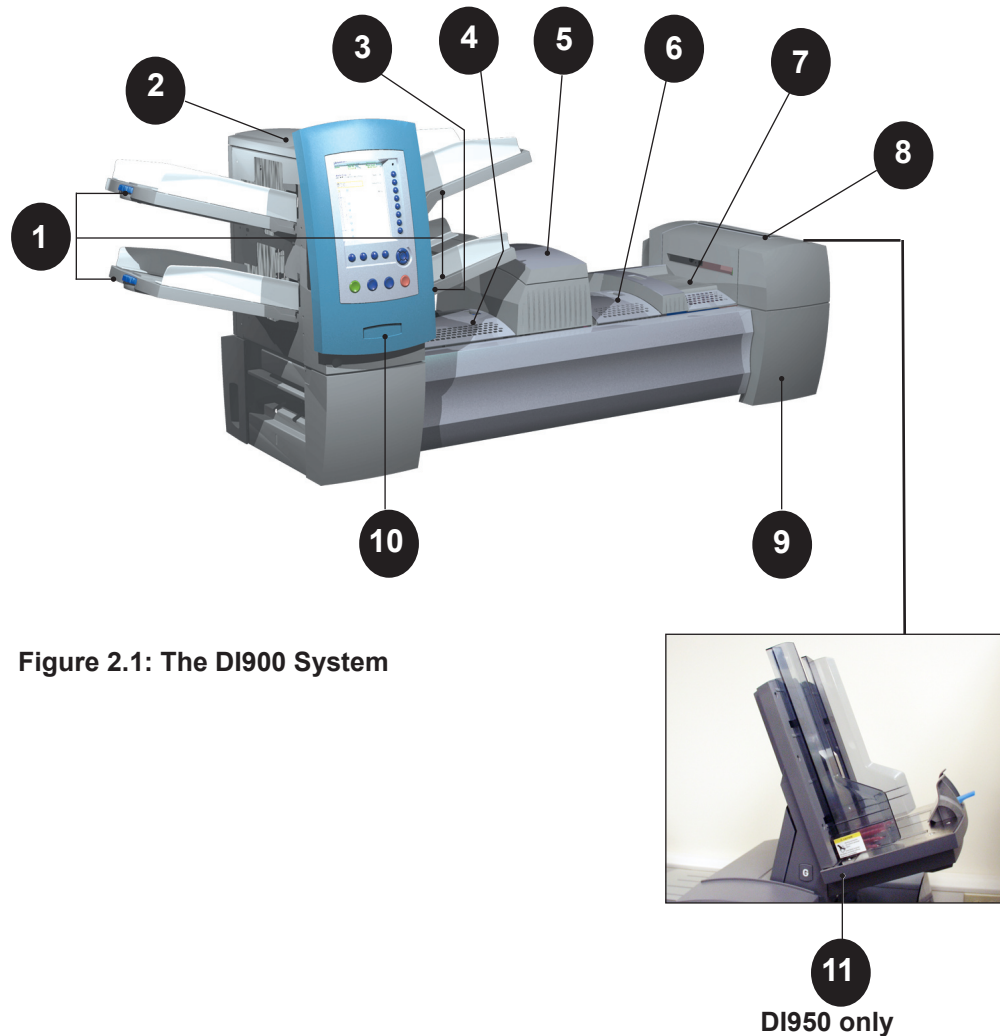

Figure 2.1: The DI900 System

- 1** **Feeder Tower Trays** - feed sheets or inserts to the Feeder Tower.
NOTE: If enabled, the lower left Tray is assigned with the letter "A" on the Mail Piece Icon Tree. When a High Capacity Envelope Feeder is not part of the system configuration, this Tray is the primary Tray for feeding envelopes designated for a given job.
- 2** **Feeder Tower** - is a two-sided Tray holder/material feeder.

System Components (continued)

- 3 **Manual Feeder** - allows you to manually feed stapled or unstapled sets of up to 5 sheets of 20 lb (80gsm) paper. The machine waits for each set to be manually fed before folding and inserting the set automatically into the envelope. The Manual Feed option is available during job creation. Inserts and/or Sheets from other Trays can also be added to the job.
- 4 **Pre-fold Accumulator** - is a staging area for the material that needs to be collated together and then sent to the Folder unit.
- 5 **Folder** - applies one of the available fold types to Sheets.
- 6 **Post-fold Accumulator** - is a staging area for the folded Sheets to meet any inserts that are to be included.
- 7 **Insertion Area** - is the part of the transport where the collation intended for a single addressee is inserted into an outer envelope.
- 8 **Moistener, Closer, Sealer** - Brushes sweep across the envelope flap to wet the glued area of the flap. The letter-size envelope then moves through the Closer and Sealer areas of the unit to complete the mail piece.
- 9 **Sealing Solution Bottle** - is located inside an opening cover at the front right side of the machine. It provides sealing solution to the envelope sealing system.
- 10 **Control Panel** - allows you to run the machine and configure job settings. It also displays the machine status and shows loading instructions and details of the job. See the following pages for more information on the controls and screen.
- 11 **High Capacity Envelope Feeder (DI950 only)** - holds at least 500 letter-sized envelopes. It feeds directly to the Insertion Area.

Drop Stacker (available on all units, not illustrated) or Power Stacker (Optional, not illustrated) - collects and neatly stacks the finished mail pieces that exit the system. The drop stacker can be unlatched from the system when it is not needed. The power stacker is mounted to the system.

2 • Meet the Inserting System

Feeder Tower

The Feeder Tower is a two-sided Tray holder/material feeder that stands at one end of the unit. Unlocking a latch on the left side of the Tower opens it to expose Feeder Exit and Tower Transport Rollers. This makes it easy to access media that may stop as it exits the Tower. Depending on the Configuration, the Tower accepts two or four Feeder Trays.

⚠ CAUTION	
	<p>Moving mechanism can result in personal injury.</p> <p>Keep hands, long hair, ties, jewelry and loose clothing away from moving parts.</p>

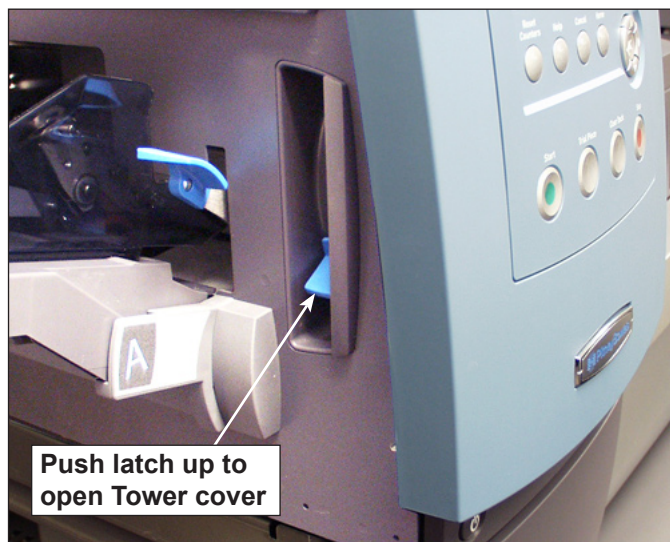

Figure 2.2.1: Latch Opens Feeder Tower.

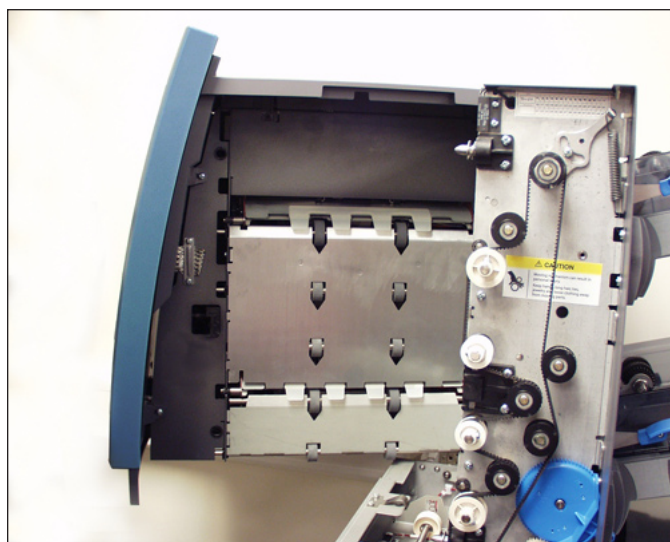

Figure 2.2.2: Two-sided Feeder Tower: Open for easy access to Feed Rollers.

Feeder Trays

There are two types of Feeder Trays:

- Sheet Trays
- Insert Trays

The required Tray type is based on the type of material selected for a given job.

Sheet Trays

Sheet Trays feed flat, unfolded material. Use only the recommended materials. Refer to the specifications in *Chapter 6*.

NOTE: Sheet Trays have fill marks on their side walls. Be sure to keep your stack of materials at or below these marks to avoid feed problems.

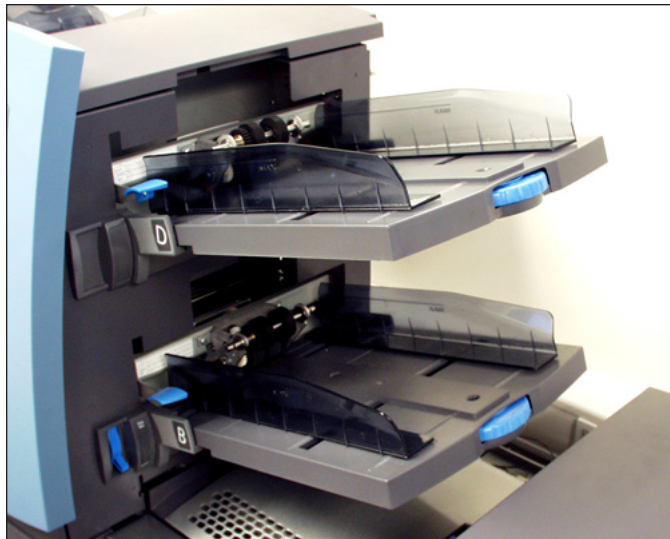

Figure 2.3.1: Sheet Trays

2 • Meet the Inserting System

Insert Trays

Insert Trays feed items that do not need folding (envelopes, cards, booklets, slips and pre-folded media) into the system. Insert Trays have a weighted sliding mechanism known as a Sled that keeps pressure on the material for proper feeding.

Insert Trays have two sets of maximum fill lines: one set for slips, and a second set for envelopes.

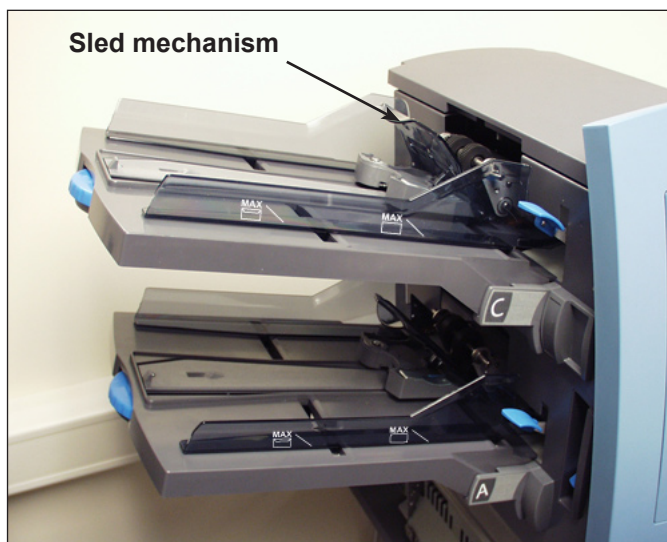

Figure 2.3.2: Insert Tray

Manual Feeder

Use the Manual Feeder to hand feed stapled or unstapled sets of up to five sheets. The machine waits for each set to be manually fed before folding and inserting the set into the envelope.

NOTES:

- The feeder type of the item (to be fed manually) in the current job has to be defined as Manual for the feature to work.
 - The job with the manual fed piece can also include items from other feeders, including sheets or inserts.
-

To use the Manual Feeder:

1. Select a job that uses the Manual Feeder.
2. Push the Manual Feed lever up.
3. Press TRIAL PIECE to start the machine.
4. Feed each set by pushing the edge into the rollers one at a time.
5. Push the lever down when you are done.



Figure 2.4: Manual Feed Lever.

2 • Meet the Inserting System

Transport Deck The Transport Deck accepts material from the Feeder Tower and moves it through the various modules to produce a finished mail piece. The Standard Transport Deck consists of the following:

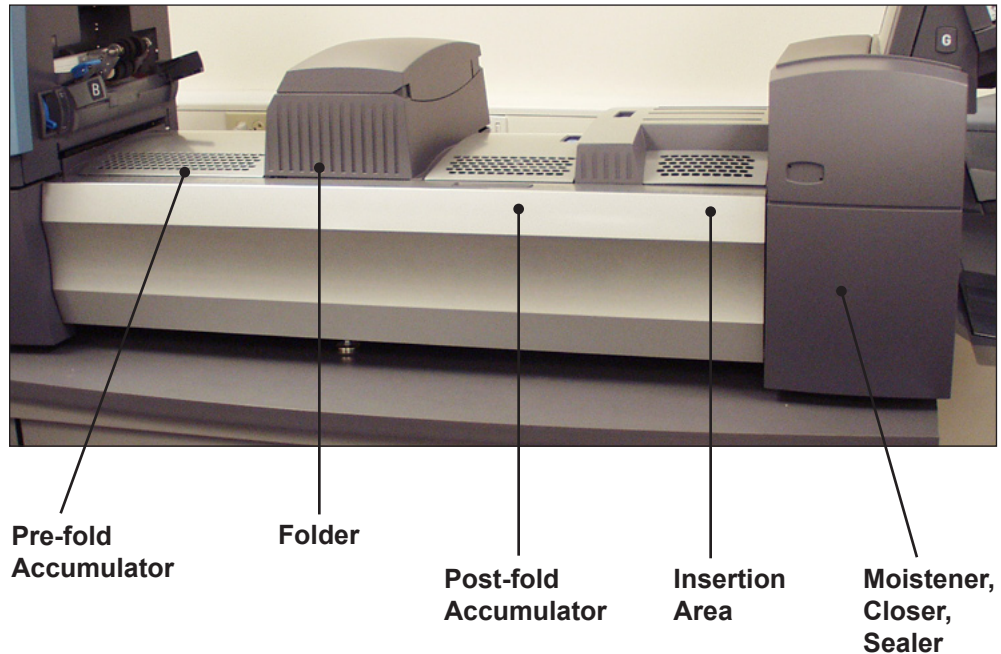

Figure 2.5: Transport Deck

Mail Piece Path Material from the Feeder Trays comes down the Feeder Tower in a pre-defined order. Material moves rapidly from one station to the next in the Transport Deck to produce a finished mail piece that is dropped into a stacking bin or onto an optional high capacity output stacker. A brief description of the function of each module in the paper path is presented next.

Pre-fold Accumulator

The Pre-fold Accumulator is the first stop in the paper path. The Pre-fold Accumulator is a stacking place for the material that needs to be collated and folded. When the appropriate components for one mail piece finish collating on the Pre-fold Accumulator, they move into the Folder.

Folder

The stack of collated sheets exits the Pre-fold Accumulator into the Folder. The Folder then applies a fold to the stack and sends it to the Post-fold Accumulator. The Folder offers these options:

- C Fold,
- Z Fold,
- Single Fold,
- Double Fold, and
- No Fold.

An optional Inverter may be used for some address location/fold type combinations.

Post-fold Accumulator

The accumulation of folded sheets exits the Folder onto the Post-fold Accumulator area. Other components of the mail piece, such as a Business Reply Envelope or a pre-folded insert, are added to the accumulation in the Post-fold Accumulator area. When all components are present, the stack moves to the Insertion Area.

Insertion Area

The contents of the mail piece meet the outer envelope at the Insertion Area. The envelope arrives at the Insertion Area with its front face down and flap open. Envelope Openers on the Insertion Area open the envelope wide enough to allow the contents to be slid inside.

Folder Bypass Path

The outer envelope, fed from the Feeder, that will contain the collated media runs through the bottom part of the Transport Deck. The route this envelope travels is known as the Folder Bypass Path.

Moistener, Closer, Sealer

As the envelope passes over the Moistener, brushes sweep across the top of the flap to wet the glued area of the flap. The envelope is then inverted and slid through the Closer and Sealer portion of the system to complete the mail piece. From there, the mail piece is dropped onto a stacker.

2 • Meet the Inserting System

About the Control Panel

The Control Panel consists of the following components:

- **Screen Option Keys** allow you to define settings for up to 24 jobs that you can store in the system's memory. These keys also provide the means to edit any of the stored jobs.
- **Fixed Function Keys** allow you to access the system's built-in tools that appear on the screen (such as the system's help file).
- **Screen Navigation Keys** allow you to move UP/DOWN and right/left in the Display and to apply selections that you've made.
- **Machine Action Keys** control hardware components and mechanical movements.
- **LED Status Indicator**

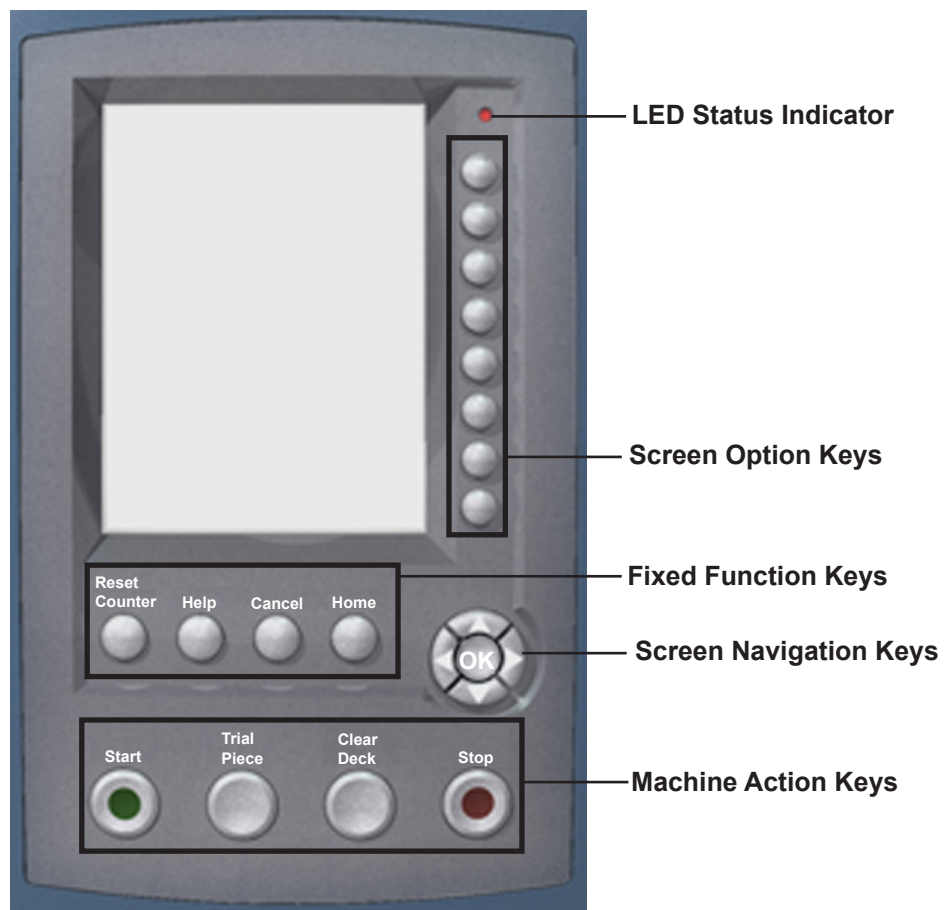

Control Panel

Screen Option Keys

The Screen Option Keys are the eight keys on the right side of the screen. These keys correspond to options on the screen, and therefore have no dedicated labels. Use these keys to highlight an item in a displayed pick list and/or to select the associated menu, item, action, or option.

Fixed Function Keys

The Fixed Function Keys are the top row of keys under the screen. Each of these keys has an assigned function that is enabled or disabled based on the screen that displays. Use of each of these keys is explained next in more detail.

Reset Counters

The system has two counters:

- Piece Counter
- Batch Counter

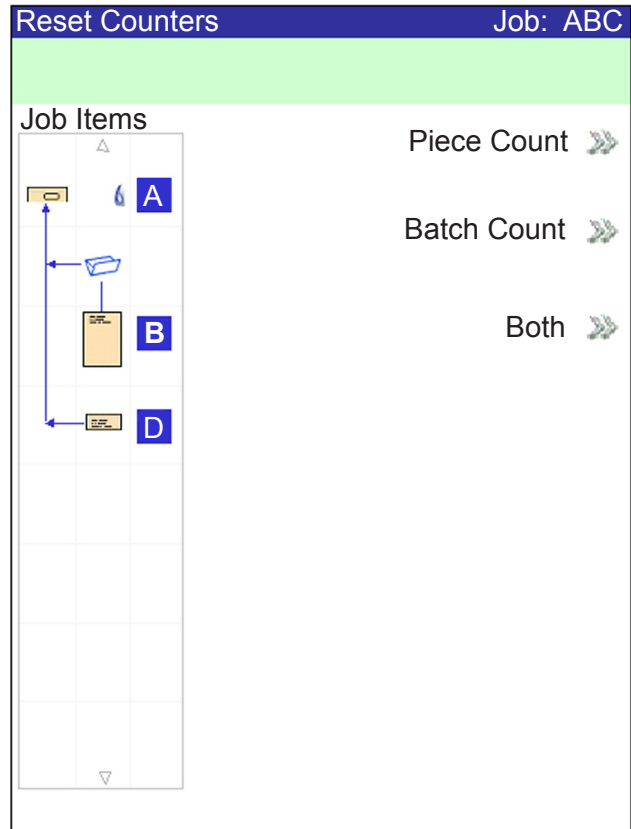

Reset Counters Screen

Resetting the Piece Counter

The Piece Counter appears in the bottom portion of the Display screen. It is a cumulative counter, i.e., it increments for each completed mail piece.

If you run the same job but for a different customer and/or use different materials, you'll need to zero the counter and ready it for counting the completed mail pieces in the new run.

To reset the Piece Counter:

1. Press RESET COUNTERS to display the Reset Counters screen.
2. Select "Piece Count".
3. You will be returned to the Home screen. The Piece Counter at the bottom of the screen will read "0".

2 • Meet the Inserting System

Fixed Function *Resetting the Batch Counter*

Keys (continued)

The Batch Counter counts up to a set number. It increments one count for each completed mail piece that the system detects. The system stops when it reaches the batch count.

To reset the desired number for the job you are running:

1. Press RESET COUNTERS to display the Reset Counters screen.
2. Select "Batch Count".
3. You will be returned to the Home screen. The Batch Counter at the bottom of the screen will return to its original setting.

NOTE: The original setting for the Batch Counter cannot be less than "5" or greater than "9999".

Resetting Both Counters

The Reset Both selection allows you to reset both the Piece Counter *and* the Batch Counter to zero.

1. Press RESET COUNTERS to display the Reset Counters screen.
2. Select "Both".
3. You will be returned to the Home screen. The Piece Counter at the bottom of the screen will read "0" and the Batch Counter will return to its original setting.

Help

Select "Help" for information about the screen that currently displays and for access to the entire Help file.

Cancel

Select "Cancel" to return to the previous screen.

NOTE: If you made changes to a job before pressing "Cancel", you are prompted to save the changes. Press "Yes" to save the changes; press "No" to delete the changes and to return to the last screen in which you saved changes. Be aware that once you delete the changes, they are permanently gone.

Home

Select "HOME" to return to the Home screen for the current job. The current job will automatically include any changes made while editing the job. Although the job can be run now, the changes are not saved until you choose "Save Job" from the menu. Jobs that have been changed but not saved have an asterisk next to the job name at the top of the Home screen.

Machine Action Keys

The four keys along the bottom of the Control Panel are called Machine Action keys. Use these keys to run the system.

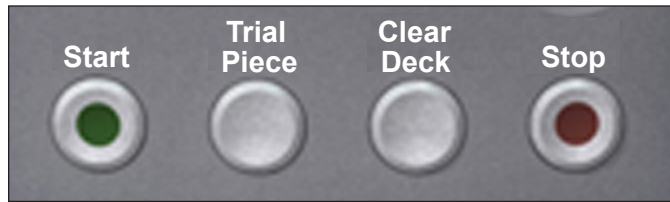

Machine Action Keys

Start

Press this green-colored key to begin running the selected job.

Trial Piece

Press TRIAL PIECE to do a test run on your job. One complete mail piece will be prepared. This allows you to verify that your job settings are correct, that the mail piece looks the way you want it to look, and that the system is functioning properly.

NOTES:

- Even if the job calls for a sealed mail piece, the trial piece will be unsealed for easy inspection.
 - Double Detect is set when the trial piece is created. Examine the contents of the mail piece to ensure the correct number of items have been inserted into the envelope.
-

Clear Deck

Press CLEAR DECK to rid the system of materials currently in process in the paper paths.

NOTE: Only press CLEAR DECK when prompted by the system to minimize lost material and manual mail piece generation.

Stop

Press STOP to finish in-process mail.

Screen Navigation Keys

The Screen Navigation Keys move the cursor on the screen. They are used to highlight items in the Mail Piece Icon Tree.

The Screen Navigation Keys consist of a two-tiered circular button. The outer tier houses UP/DOWN and LEFT/RIGHT Arrow Keys that move the cursor UP/DOWN and LEFT/RIGHT on the screen. The inner tier of the Screen Navigation Keys is an OK button.

Press OK whenever you want to apply the selection that you made using the Arrow Keys.

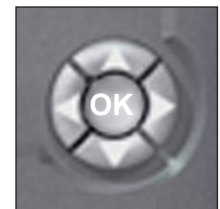

Screen Navigation Keys

2 • Meet the Inserting System

Display Screen The Display screen is divided into two major areas:

- Header area
- Status area

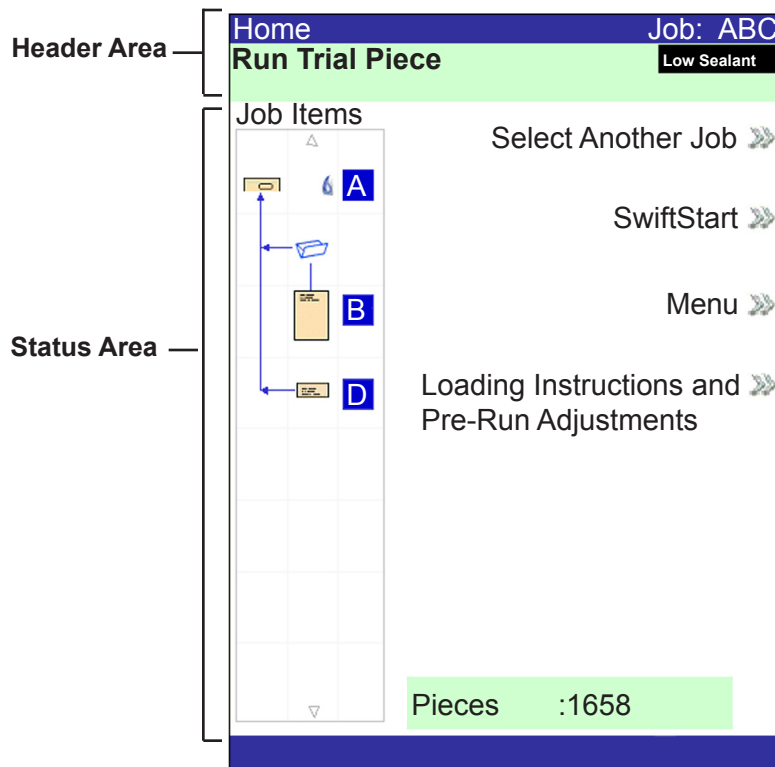

Display screen

Header Area

The Header area has two colored bands that run across the top of the screen: the top band is blue, the bottom band is green. The left side of the top band displays the name of the screen in which you are working. Depending on the screen you select, the Job Name may show on the right side of this area. The green band displays instructions and screen navigation directions.

The top (blue) band displays the name of the screen and Job.

If the job uses the Attached Printer, the mail run name displays in the middle of the top (blue) band.

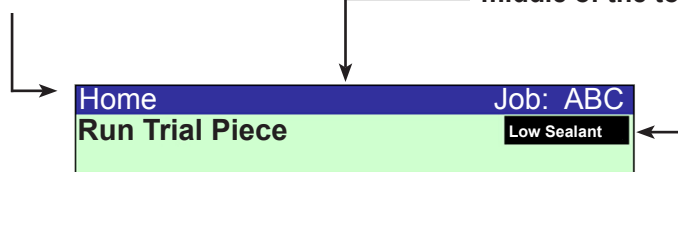

The bottom (green) band displays the instructions and screen navigational directions.

Status Area

The Status area of the screen is devoted to displaying information about the task(s) you are performing. This area displays any or all of the following:

- Mail Piece Icon Tree
- Item Orientation
- Options
- Data displaying across the bottom of the screen in the Home screen only includes batch count, piece count and User ID.

Mail Piece Icon Tree

The Mail Piece Icon Tree is located on the left side of the screen. The Tree displays an icon for each component in the mail piece and a fold icon, if the material is to be folded. **The icons are arranged in the order in which the mail piece components will be collated, with the outer envelope icon showing at the top of the Tree.** A letter appearing alongside the icon designates the Feeder Tray assignment; a small blue droplet icon indicates that the seal feature is enabled.

- Each icon has one darker edge either at the top or bottom that indicates the leading edge of the material. The leading edge of an object is the edge that feeds into the machine first. For example, a sheet that must be loaded face up with the top of the sheet leading would be represented by a "face-up" sheet icon containing a "leading edge" line on top.

Leading Edge



- A Feeder assignment letter will be placed alongside the icon to indicate the Feeder Tray to load the object into. Two or more feeder assignment letters alongside a single icon indicate that Feeder Trays have been linked. The item should be loaded in all the Feeder Trays indicated. When one Feeder Tray becomes empty, feed will automatically switch to the next linked Feeder Tray, in a continuous cycle.
- If Double Detect is in use, the Double Detect icon will appear immediately to the left of the relevant icon.

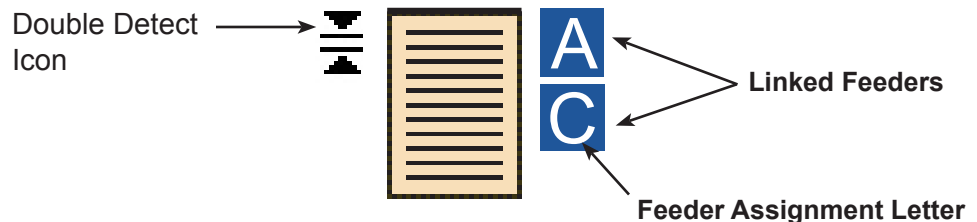

2 • Meet the Inserting System

Status Area (continued)

- If any Sheet Feeder(s) are programmed to feed multiple sheets, a modified icon indicating multiple sheets will appear together with a number showing the number of sheets in the set.

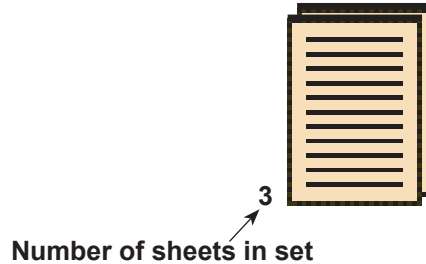

- On a scanning (OMR or Barcode) job, a variable number of sheets might be fed under control of the OMR or Barcode marks and so a small letter "n" will appear in place of the number.

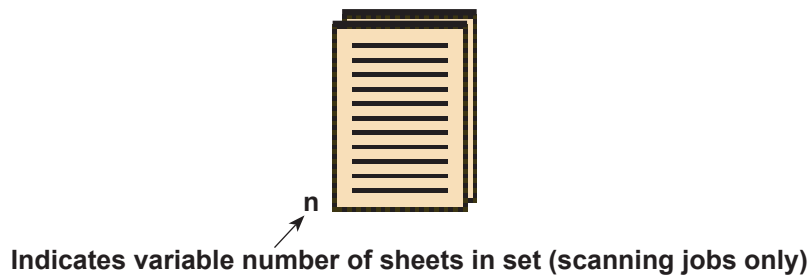

- Lines between the icons indicate the way the mailpiece is assembled. The outer envelope is at the top of the icon tree.
- Making any change to the job settings can cause the Feeder Tray assignments to change in the Mail Piece Icon Tree.

NOTE: Any time the job set up changes, be sure to check the Mail Piece Icon Tree for changes in the Feeder Tray assignments.

Status Area (continued)

Mail Piece Icon Tree Example

Each icon displays important information about the mail piece component that it represents. The following explains information conveyed by the icon and how it assists you in loading and running a job.

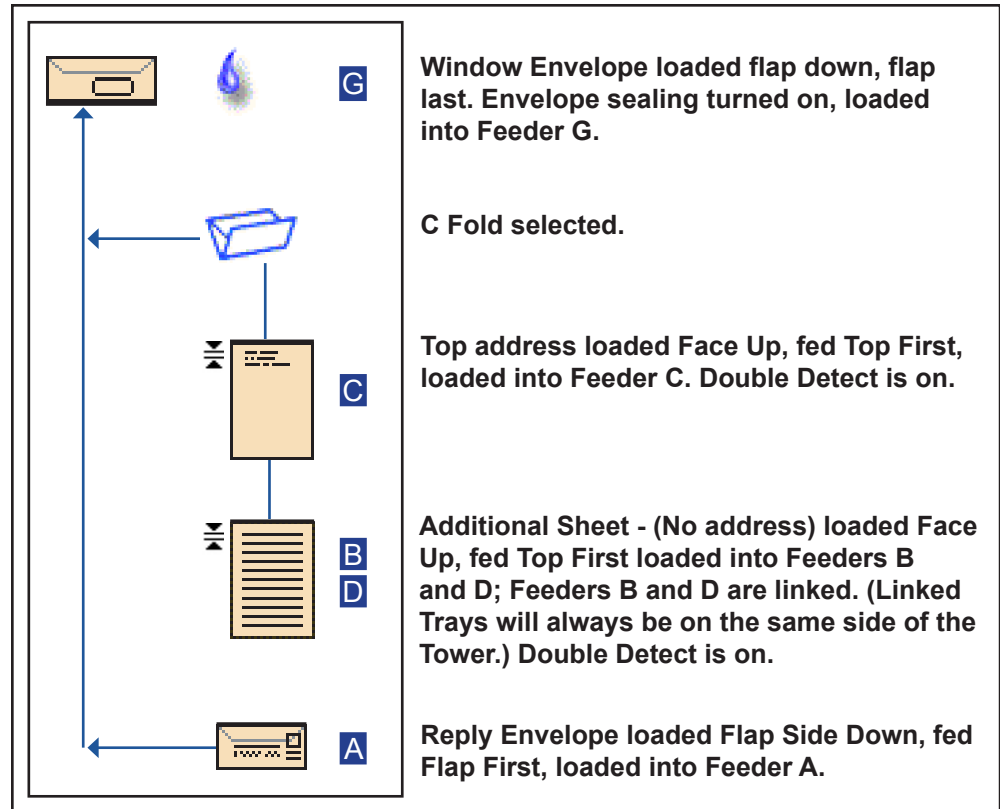

Example: Mail Piece Icon Tree

NOTES:

- In the example above, the Top Address, Additional Sheet and C Fold icons represent a set. That is, the Top Address and Additional Sheets are accumulated together, and the C Fold is applied to them.
- An Insert (see the Reply Envelope icon, above) always appears as a single set within the Mail Piece Icon Tree.

2 • Meet the Inserting System

Status Area (continued)

Item Orientation

Use the Screen Navigation Keys to highlight an icon in the Mail Piece Icon Tree to display information about the item that the icon represents. In most instances, a picture appears in the Status Area of the screen and shows the required orientation for loading the item into the Tray.

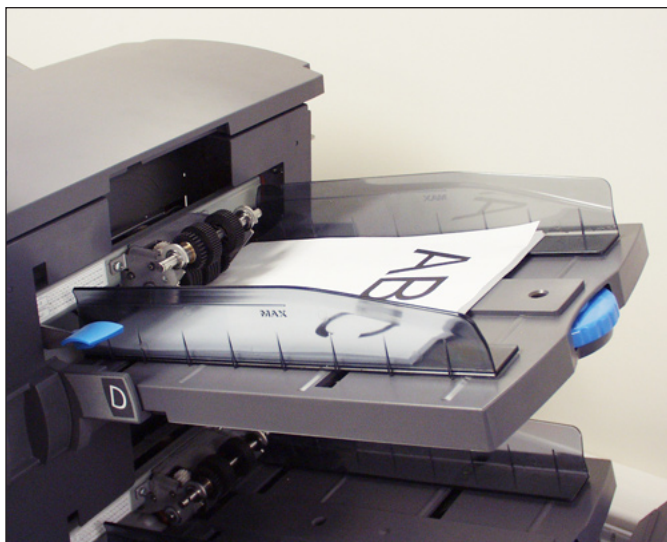
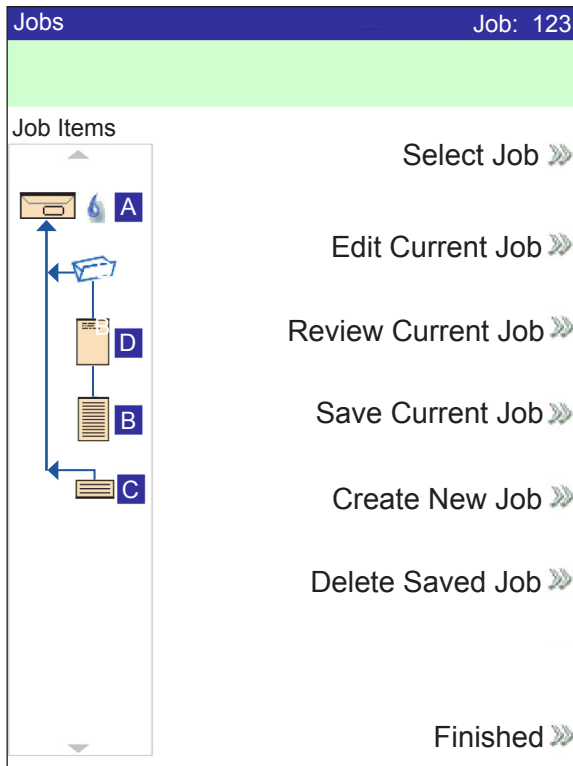

Figure 2.6: Sample - Material Orientation Picture

Status Area (continued)

Options

The right side of the Display screen lists the options that are available for the screen that currently displays. In some screens, options consist of other functions: in other screens options consist of different settings for a selected item in the screen. Selection of the available options is done via the Screen Option Keys, that were described earlier in this chapter. See the example screens below.



Example: Functions Display

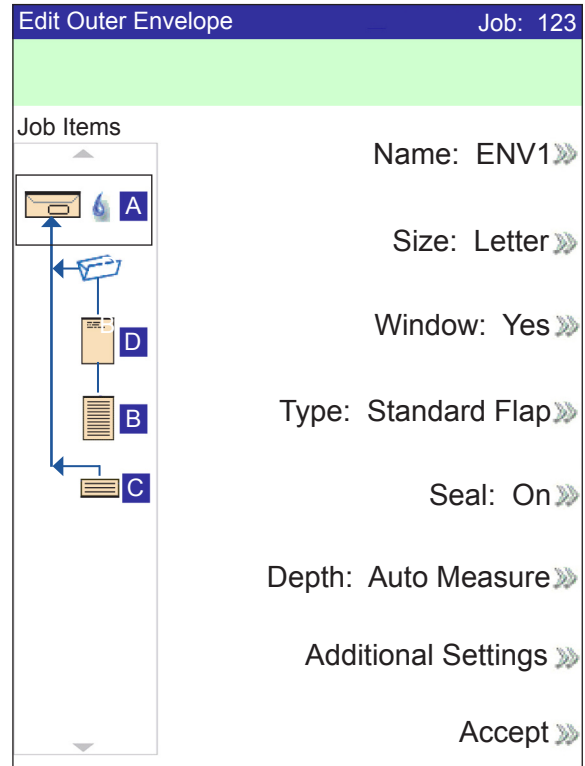

Example: Options Display

NOTE: Two Chevrons (>>) indicate that there is a submenu of options. One Chevron (>) indicates that there is a toggle between two choices, such as Yes/No or On/Off.

Footer

Data across the bottom of the Home screen identifies the user and account.

2 • Meet the Inserting System

Access Rights

There are two security modes available on the system:

- Login Not Required Mode - requires four-digit access code to perform supervisor and manager functions.
- Login Required Mode - sets up access levels and requires a user ID and password for all system operator, supervisor, and manager functions.

The system has three levels of user access, and one level for service personnel. The three user access levels are:

- Operator
- Supervisor
- Manager

Depending upon the security mode, the supervisor and manager access levels requires entry of an access code *or* user ID and password. These are assigned by the system manager.

Operators have access to any of the function *not* listed as supervisor or manager functions. System operators may be required to log in and out of the system, if a security mode has been enabled.

Chapter 3 describes the steps involved with performing each of the non-restricted procedures.

Supervisors have access to all Operator functions and the following after logging in with the correct access code *or* user ID and password:

- Saving a Job
- Deleting a Job
- Creating Accounts
- Deleting Accounts

Chapter 4 describes the steps involved with performing these supervisor-level functions.

Managers have access rights to all of the above functions plus exclusive rights to manage other users, i.e., assign/restrict functions and selecting the Account Mode.

Chapter 4 explains the process for assigning user IDs and passwords and selecting the Account Mode.

Access Rights (continued)

When the Login Required Mode is enabled, entry of a user ID and password is needed to access the system. When Login Not Required Mode is enabled, entry of an access code is needed to access restricted functions.

NOTE: The Manager assigns the user ID and password or access code. User IDs can contain alphanumeric characters; access codes and passwords *must* be numeric only.

Logging In

If one of the two security modes is enabled on your system, you must log in to perform operator functions:

1. The Select User screen displays. Select the appropriate user ID.

NOTE: If necessary, press "Next" to view additional user IDs.

2. Enter your password.

NOTE: Passwords are four-digit numeric codes. Numbers 1, 2, 3, 4 and 5 display on the first screen. Press "Next" to access numbers 6, 7, 8, 9, and 0.

3. Press "Accept" once you have entered your password. The Home screen displays.

If Login Not Required Mode is enabled on your system and user IDs and passwords have been set up by the Manager, the Log In option displays on the Home screen.

Logging Out

To log out of the system: on the Home screen, select "Log Out".

NOTE: You must log out of the system in order for the next operator to log in.

2 • Meet the Inserting System

About System Covers

Three covers on the front side of the system, as shown in the figure below, open to provide access to Paper Release Knobs.

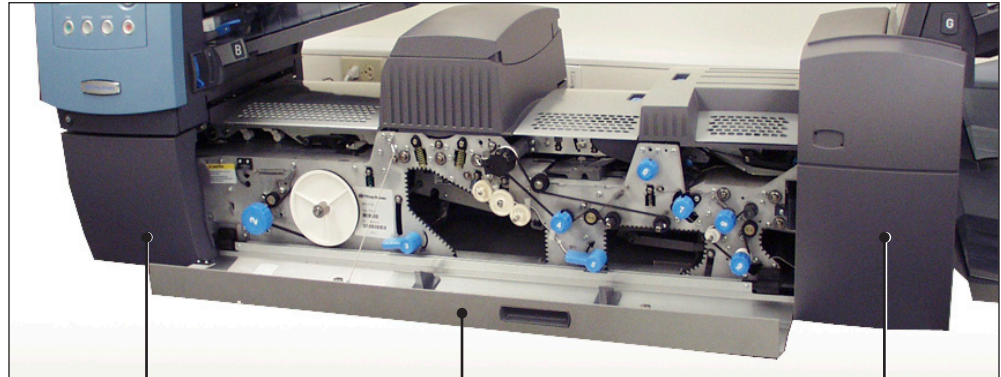

**Tower Base Cover
(closed)**

**Main Transport
Deck Cover
(open)**

**Sealer Replacement
Cover
(closed)**

Figure 2.7.1: Front Covers

Covers on the top of the Transport Deck open to provide access to the rollers in the main paper path:



**Pre-fold
Accumulator
Cover**

**Folder
Cover**

**Post-fold
Accumulator
Cover**

**Insertion
Area
Cover**

Figure 2.7.2: Top Covers

Opening the Covers

The Tower Base Cover interlocks with the Main Transport Deck Cover. This means that you cannot open the Tower Base Cover unless you open the Main Transport Deck Cover first.

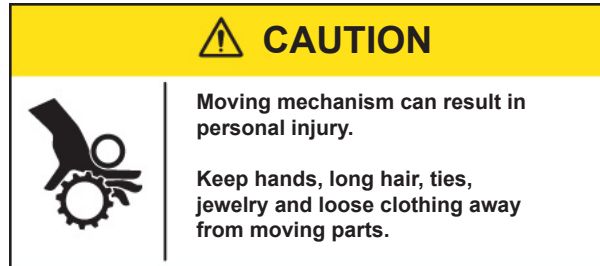

To open the Main Transport Deck Cover:

1. Place your fingers into the slot on the top of the cover.
2. Pull down gently. A security tie keeps the cover within the recommended range of movement.

IMPORTANT: Do NOT lean on the open cover.

To open the Tower Base Cover:

1. Open the Main Transport Deck Cover.
2. Pull down on the Tower Base Cover handle.

Closing the Covers

To close the Lower Tower and/or the Main Transport Cover, push the cover up until it is seated in place on the system deck.

2 • Meet the Inserting System

About the Paper Release Knobs/Levers

There are ten Paper Release Knobs and Levers on the front side of the system. Each knob provides the means to turn rollers, and thus move material out of the area in which it stalled. Each Paper Release Lever opens an area of the system and allows you to clear any material that may have stalled.

The illustrations below indicate the various knob/lever locations, as well as the areas each knob moves material through and each lever opens.

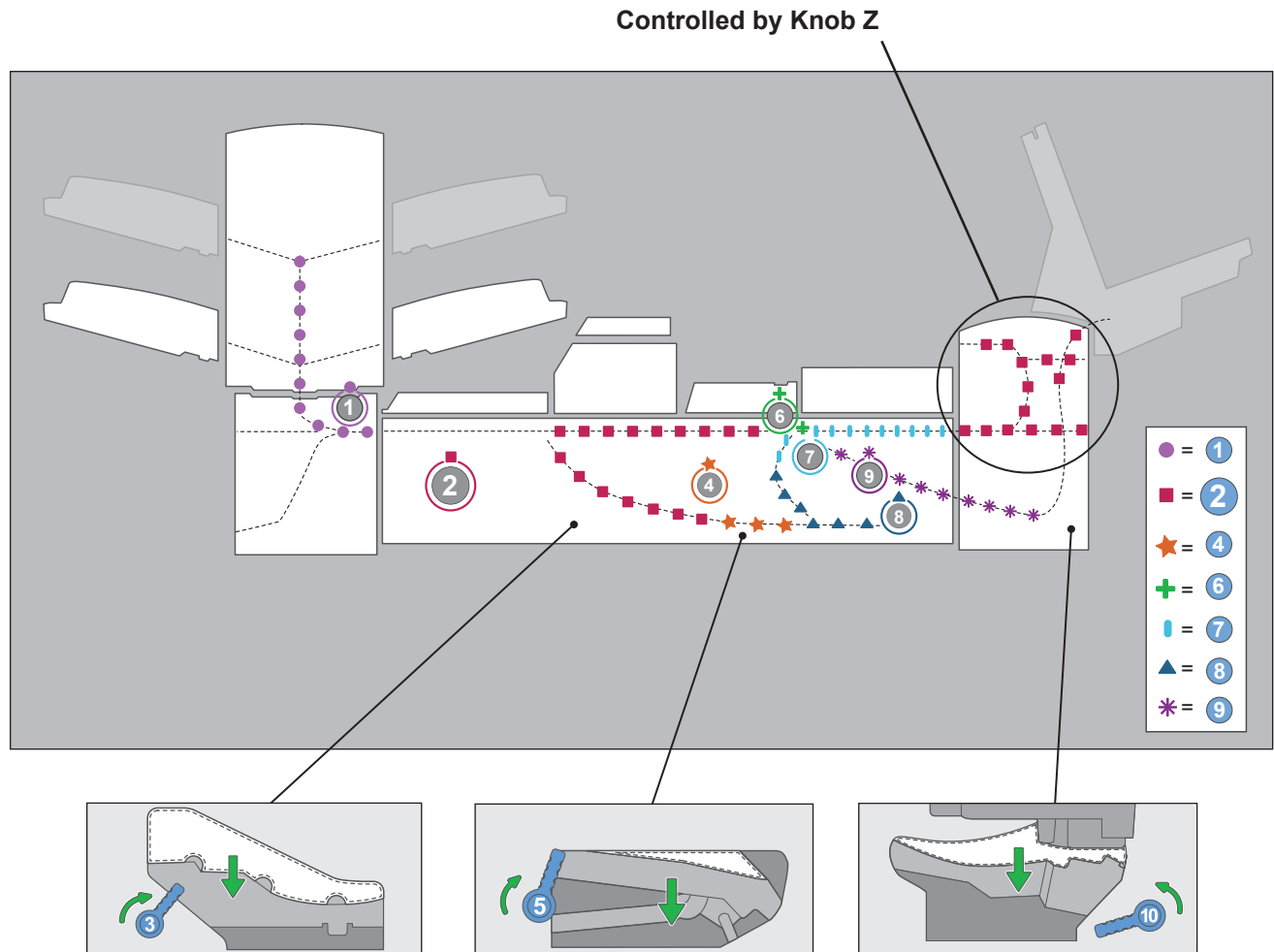

Paper Release Knob/Lever Locations and Related Areas

About Add-On Modules

The system accepts a number of additional modules. Refer to the *Chapter 7* for more information.

3 • Basic Operation



Connecting to Power	3-2
Powering Up	3-2
Home Screen.....	3-3
Job Overview.....	3-4
Selecting the Job	3-5
Setting Up Feeders and Loading Materials	3-6
Attaching Trays to the Feeder Tower	3-6
Removing Trays from the Feeder Tower	3-7
Loading Material into the Trays	3-8
Loading the DI950 High Capacity Envelope Feeder (HCEF)	3-13
Making Pre-Run Adjustments	3-18
Adjusting the Envelope Openers	3-18
Running a Trial Piece	3-22
Reviewing the Job Settings	3-24
Starting the Job	3-25
SwiftStart™ Jobs.....	3-25
Using SwiftStart™	3-26
Creating a Job	3-26
Job Options	3-30
Envelope Options	3-30
Fold Options	3-32
Sheet Options.....	3-33
Insert Options	3-36
Editing a Job.....	3-39
Modifying Job Settings	3-40
Editing an Item.....	3-40
Adding an Item	3-41
Moving an Item	3-43
Deleting an Item	3-44

3 • Basic Operation

Connecting to Power



WARNING! Read the safety information in *Chapter 1* before connecting the system to power.

To connect the system to power:

1. Connect the power cord to the socket on the back of the machine.
2. Plug the power cord into a suitable power outlet. Make sure the power outlet is near the machine and is easily accessible.

Powering Up

Press the ON/OFF switch (located below the Control Panel) to start the power up process.

NOTE: If a High Capacity Sheet Feeder (HCSF) is present, power on before you power on the base.

The system will automatically conduct a number of checks to verify the operational integrity of the system. If any problems are detected, the system will display information directing you to a solution to the problem.

NOTE: When power cycling the system, be sure to power cycle any optional add-on equipment as well.

Home Screen

When the system completes the startup process, the Home screen will display. The last job that was run will display on the Home screen. Information about the job displays along with the means to select a different job, edit settings for the displayed job, use the SwiftStart™ feature, and view loading instructions for the selected job.

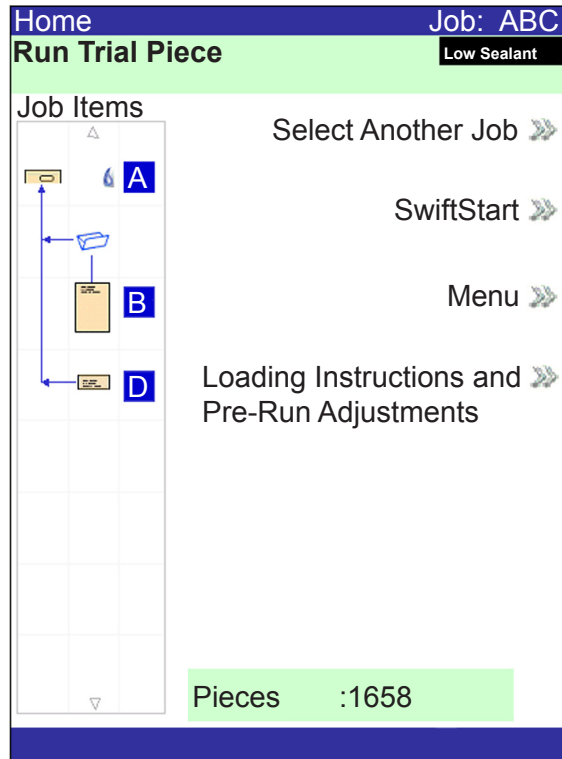

Home Screen

If you need to adjust the screen brightness or contrast, refer to *Chapter 5* for detailed procedures.

3 • Basic Operation

Job Overview

This chapter provides the instructions necessary to run, create, or edit a job.

Running a Job - There are five major steps involved with running a job. These steps need to be followed in the order listed below:

- *Selecting the Job*
- *Setting Up Feeders and Loading Material*
- *Making Pre-Run Adjustments (if necessary)*
- *Running a Trial Piece*
- *Starting the Job*

This chapter explains each of these steps in detail. The content in this section assumes that the job to be run exists in the Saved Jobs list in your system.

NOTES:

- The Job Items list represents the order the items in your mail piece will be shown. The first item below an outer envelope in the Job Items list will be the top document when the contents are removed from the envelope.
- The Sheet and Insert icons in the Job Items list *do not* represent a single Sheet or Insert, but rather the stack or pile of material that is loaded into a Feeder.
- Follow the loading instructions each time before you run a job. The loading orientation may change, depending on the Feeder assignment and job settings. For instance, one Feeder may need to be loaded bottom first and another top first.
- Feeder assignments are determined by the machine to best optimize the job. This means they are assigned only after a job is selected. Also note that after editing a job the Feeder assignments may change.
- The system automatically adjusts for most materials. However, if the throats of your outer envelopes vary significantly, a manual adjustment may be needed. Likewise, if different width or length sheets are fed from a HCSF (High Capacity Sheet Feeder), there are adjustments to be made.

Creating a Job - If the job does not exist, it must be created and saved by a Supervisor/Manager. Refer to *Creating a Job* in this chapter for more information.

Editing a Job - If the job requires modification it can be edited and run, but must be saved by a Supervisor/Manager. Refer to *Editing a Job* in this chapter for more information.

Selecting the Job

If the job that you want to run is the one that currently displays in the Home screen, proceed to the *Running a Trial Piece* section of this chapter. Otherwise, follow the steps below to select the job:

1. From the Home screen:
 - Select "Select Another Job" to view a list of saved jobs. Skip to step 3, below.

OR

 - Select "Menu", then "Jobs", and finally "Select Job". The Select Job Type screen displays.



Select Job Type Screen

2. The Job Type screen provides access to all the jobs that are in your system. This screen displays three categories to search for the job that you want to run:
 - "Saved Jobs" displays the list of jobs that you created and saved.
 - "Recently Run Jobs" displays a list of the last 8 jobs that your system ran. This list shows each job's name and the date/time that the job ran.
 - "Library Jobs" displays the names of the pre-defined jobs that came loaded on your system.Select the desired category to display the list of jobs that are available in that category.
3. Select the desired job from the list.
 - If the job does not appear on the first page, use the UP/DOWN arrow keys to scroll through the list.
 - As any job is highlighted in the list, the Mail Piece Icon Tree for the job appears on the display so that it can be identified

3 • Basic Operation

Setting Up Feeders and Loading Materials

Once you select the job that you want to run, you need to set up the system to run it. This consists of doing the following:

- *Attaching Trays to the Feeder Tower*, if prompted.
- *Loading Material into the Trays* as directed by the Mail Piece Icon Tree and the loading instructions for the selected job.
- *Loading the HCEF (High Capacity Envelope Feeder)*, if necessary.

The following sections provide more detail about these tasks.

NOTE: If a HCSF (High Capacity Sheet Feeder) is present, you will need to load material into it. Refer to *Adjusting the HCSF Guides* in *Chapter 7* for more information.

Attaching Trays to the Feeder Tower

The procedure for attaching either type of Tray to the Feeder Tower, at the location indicated by the Mail Piece Icon Tree and loading instructions, is essentially the same:

NOTE: Use both hands when attaching or removing a Tray.

1. Align the back end of the Tray with the tray mounts in the Feeder Tower.
2. Lift the Separator by pushing up on the Separator Lift Lever (located on the side of the Feeder Tower).

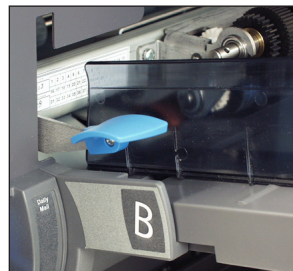

Push the lever up to lift the separator.



Figure 3.1.1: Lift the Separator and slide the Tray into the tray mounts.

- Slide the Tray into the tray mounts until you feel the Tray seat into place.

NOTE: The Tray is seated properly when the notch on the bottom of each side of the Tray is seated in the groove on each of the tray mounts.

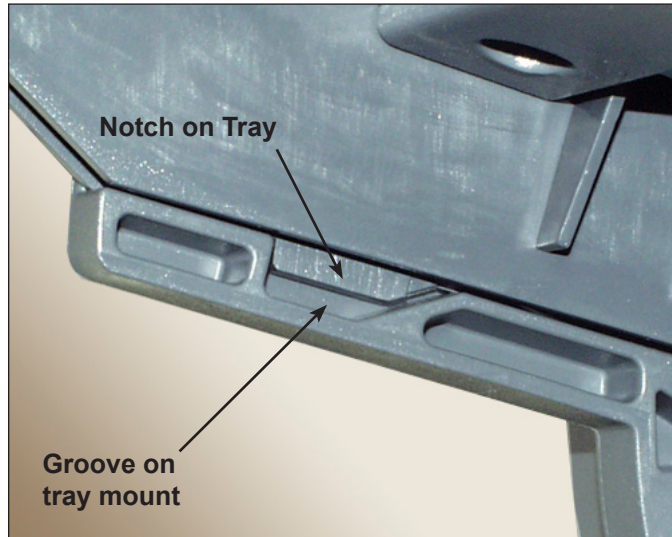

Figure 3.1.2: Tray Seated Properly in Tray Mount (Bottom View)

- Pull straight back on the Tray slightly, and at the angle at which the Tray sits, to ensure it is securely attached. If it isn't, repeat the procedure until the Tray seats properly and securely.

Removing Trays from the Feeder Tower

The procedure for removing a Sheet or Insert Tray consists of the following:

- Grasp the open end of the Tray and lift up.
- Slide the Tray out until it clears the grooves in the tray mount.

3 • Basic Operation

Loading Material into the Trays

It is important to loosen (fan) any items in the stack that may be stuck together BEFORE you place the material in the Tray. To do this:

1. Hold one end of the stack in one hand.
2. Flip through the opposite end of the stack with your other hand.
3. Repeat this with the other end of the stack.



Figure 3.2: Loosen (Fan) Material

Tray Information

The Mail Piece Icon Tree in the Home screen provides information about each item in the mailing. Each icon represents a document in the current job. Use the Arrow Keys to highlight any document icon. When an icon is highlighted, any or all of the following information will display:

- Graphic of the document/media type.
- Tray type into which the document/media should be loaded.
- Orientation of the document in the Tray.

Loading Material into the Trays (continued)

Adjusting Tray Side Guides

A grooved, blue Side Guide Adjustor is present at the open end of each Tray. This Adjustor controls the opening and closing functions of the Tray's Side Guides.

To open or close the Side Guides on Sheet and Insert Trays on the Feeder Tower:

1. Place the palm of your hand against the Side Guide Adjustor at the open end of the Tray.
2. Use the palm of your hand to turn the Side Guide Adjustor:
 - Turn the Adjustor counterclockwise to move the Side Guides in towards the material.
 - Turn the Adjustor clockwise to move the Side Guides out and away from the material.
3. When the Side Guides contact the material in the Tray, remove your hand from the Adjustor. The Guides will automatically spring back from the material and leave a space about the thickness of an envelope (1.4 mm). This spacing allows for proper material feeding.

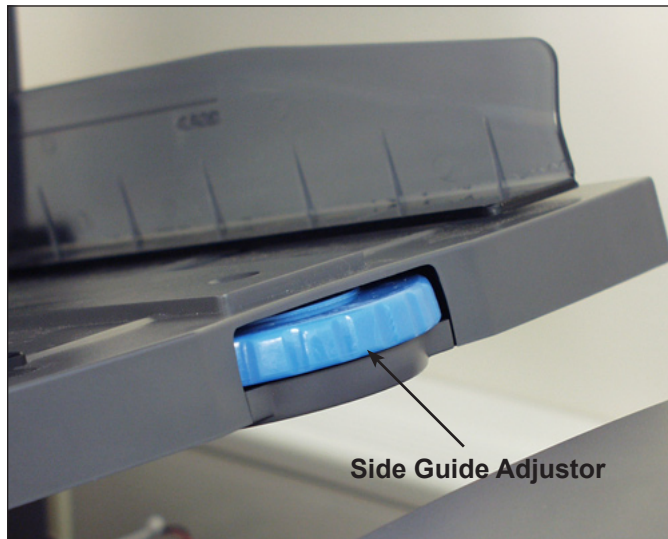

Figure 3.3: Side Guide Adjustor

NOTES: DO NOT pull or push on the Side Guides to move them. Always use the Side Guide Adjustor to move the Side Guides.

3 • Basic Operation

Loading Material into the Trays (continued)

Loading a Sheet Tray

NOTE: To view a demo of the Sheet Tray loading and Side Guide adjustment processes: go to the Home screen and select “Loading Instructions and Pre-Run Adjustments”. Use the UP/DOWN arrow keys to select a Sheet (being fed by the Feeder Tower) from the Mail Piece Icon Tree, then select “Feeders Setup Demo”.

To load media into a Sheet Tray:

1. Using the Side Guide Adjustor, open the sides of the Tray wide enough to clear the width of the material.
2. Fan a small stack of material and then place it into the Tray, in the orientation specified in the loading instructions on the Home screen.

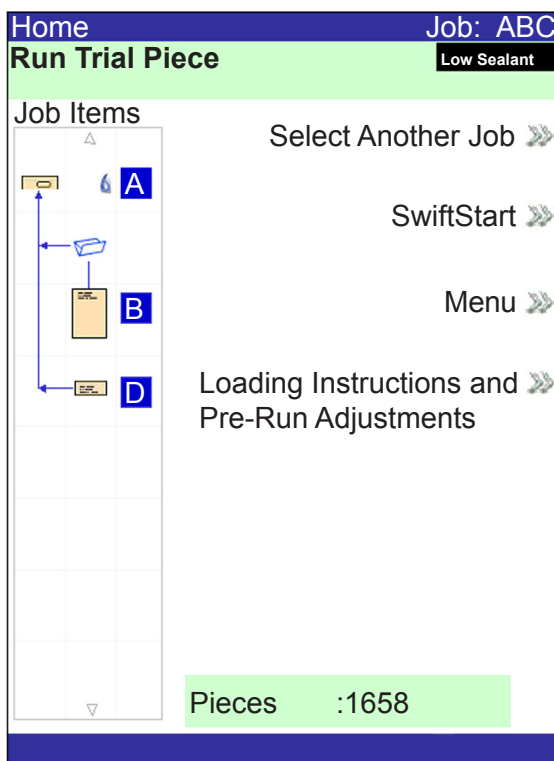

Home Screen

3. Using the Side Guide Adjustor, move the Side Guides in until they lightly touch the material on both sides.
When you release the Adjustor, the Guides will automatically spring back to a position that will allow for proper clearance during feeding of the material in the Tray.

NOTE: Side Guides only spring back after they are moved inward.

4. Lift the Separator and load material into the Tray.

NOTE: Do not load material above the maximum fill line in the tray.

For more information on Side Guide adjustments, see *Adjusting Tray Side Guides* in this chapter.

Loading Material into the Trays (continued)

Loading Insert Trays

NOTE: To view a demo of the Insert Tray loading and Side Guide adjustment processes: go to the Home screen and select “Loading Instructions and Pre-Run Adjustments”. Use the UP/DOWN arrow keys to select an Insert in the Mail Piece Icon Tree, then select “Feeders Setup Demo”.

To load material into an Insert Tray:

1. Use the Sled Locking Lever to slide the Sled to the end of the Tray. The Sled will automatically lock in place.
2. Using the Side Guide Adjustor, open the sides of the Tray beyond the width of the material.
3. Stand a stack of material straight up and against the front end of the Tray, and in the orientation specified on the Mail Piece Icon Tree and Home screen loading instructions.

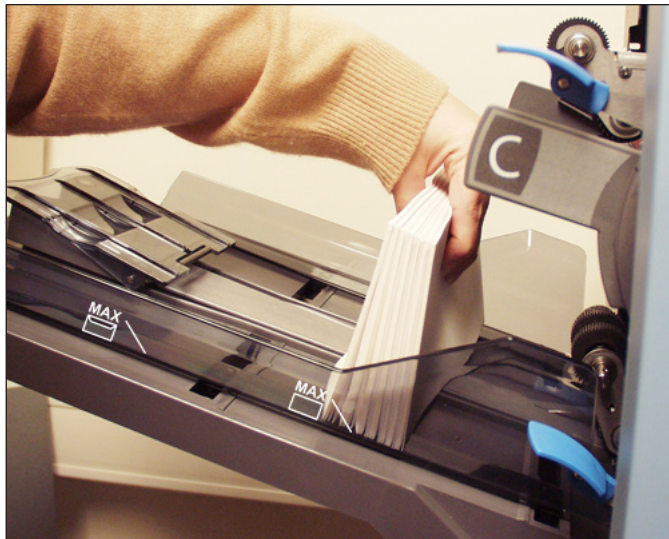

Figure 3.4.1: Stand the Inserts

4. Using the Side Guide Adjustor, bring the sides of the Tray **lightly** against the material, then release the Adjustor. The Guides will automatically spring back to a position that will allow for proper clearance during feeding of the material in the Tray.

NOTE: Side Guides only spring back after they are moved inward.

For more information on Side Guide adjustments, see *Adjusting Tray Side Guides* in this chapter.

3 • Basic Operation

Loading Material into the Trays (continued)

Loading Insert Trays (continued)

5. Finish loading the Tray to the appropriate fill line for the insert type.
6. Tilt the material slightly toward the back of the Tray.
7. While holding the material in the tilt position, *gently* pull up on the Sled Lock Release to unlock it. Allow the Sled to move forward.
8. Slide the Sled until it contacts the end piece in the stack of material, and then release your hold on the material.

NOTE: Items in the Mail Piece Icon Tree on the Display represent the material in the selected job. Use the Arrow keys to highlight any icon to view a picture of the orientation of material in the Tray, and the designated location of that Tray on the Feeder Tower.

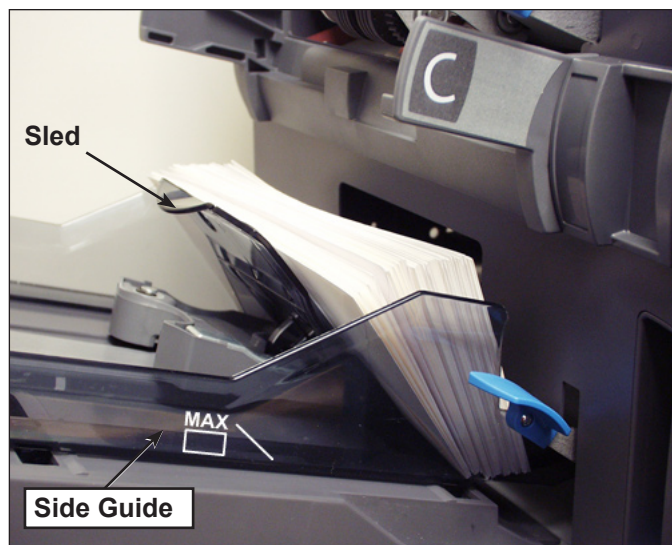

Figure 3.4.2: Final Position of Inserts

Loading the DI950 High Capacity Envelope Feeder (HCEF)

The HCEF holds up to 500 envelopes. Refer to *Chapter 6, Reference* for the envelope size ranges.

To load envelopes into the HCEF, you will need to adjust the Side Guides, Wedge, and Separator Gap. Before you begin making any adjustments, fan a stack of envelopes and remove any that are nested, curled, or damaged in any way.

NOTE: To view a demo of the Wedge (wedge) and Separator Gap adjustment processes, go to the Home screen. Select “Loading Instructions and Pre-Run Adjustments”. Use the UP/DOWN arrow keys to select the envelope being fed by the HCEF, then select “Feeders Setup Demo”.

Adjusting the HCEF Side Guides

1. Place an envelope between the Side Guides.
2. Using the Adjustor knob, bring the Side Guides in to lightly touch the envelope.
3. Release the knob. The Guides will spring back to the correct position to allow free sliding of the envelope between the Side Guides.

NOTE: Side Guides only spring back after they are moved inward.

4. Make sure the envelope slides freely between the Side Guides when it is placed flat on the red feed belts.

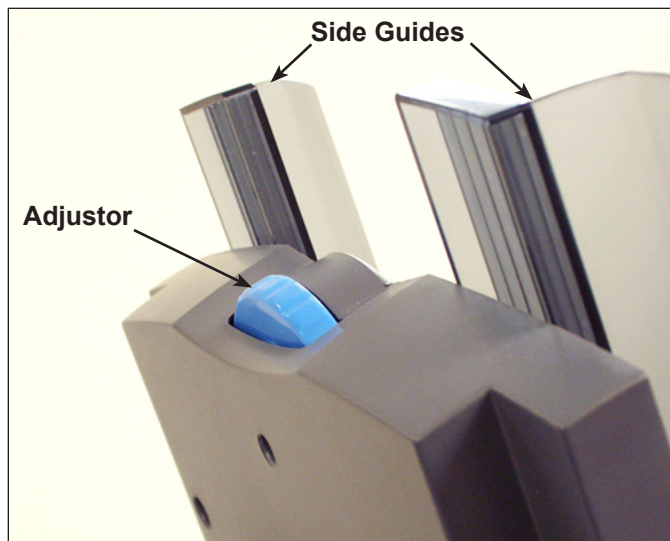

Figure 3.6: Adjusting the HCEF Side Guides

3 • Basic Operation

Loading the DI950 HCEF (continued)

Adjusting the HCEF Wedge

1. Insert an envelope into the HCEF with the bottom edge of the envelope against the Center Guide, in line with the two screws. The top edge of the envelope (edge with flap) should point towards the Wedge.

NOTE: Ensure the envelope is centered, *not angled*, on the Center Guide to obtain correct positioning. If the position of the envelope is incorrect, the Separator Gap adjustment will be incorrect as well.

2. Push up and release the blue Wedge Locking Lever.
3. Slide the Wedge toward the envelope, until the top edge of the envelope fits into the center slot of the Wedge.

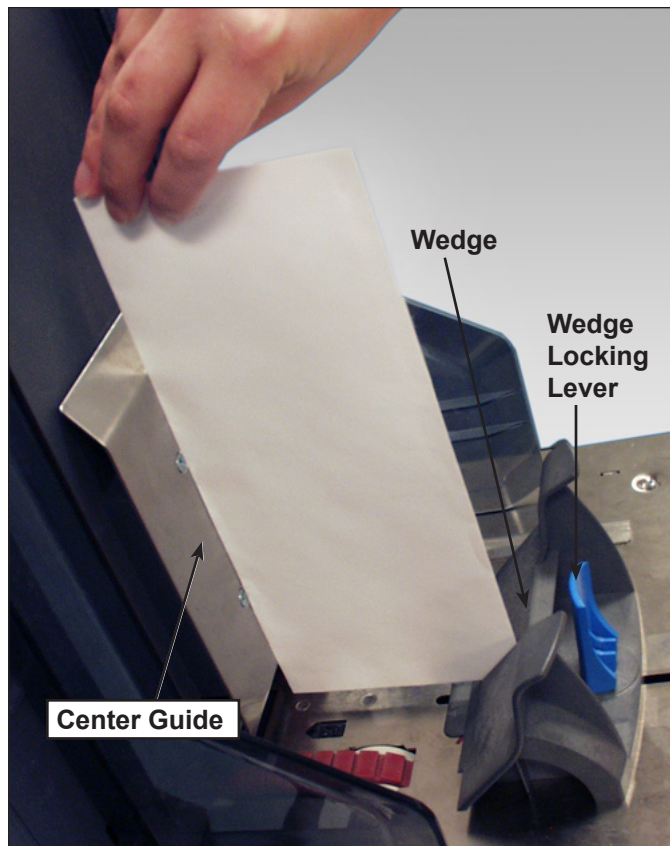

Figure 3.7.1: Adjusting the Wedge Position

**Loading the
DI950 HCEF
(continued)**

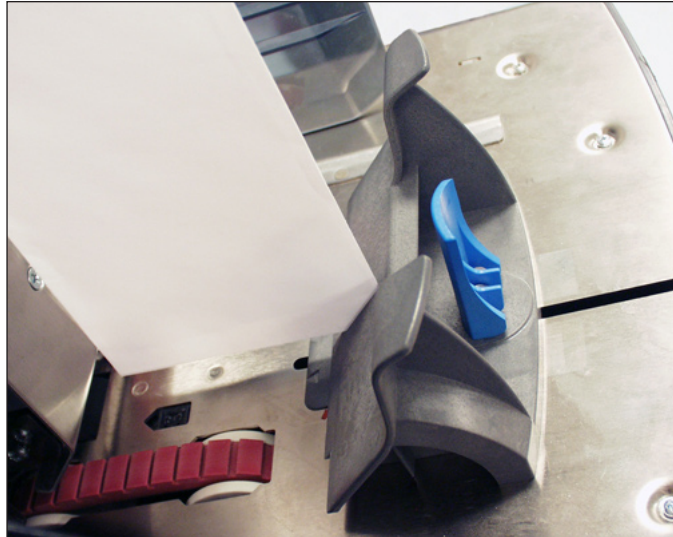

Figure 3.7.2: Corner of Envelope in Center Slot

4. Push down on the Trail Prop Locking Lever to lock the Wedge into place and remove the envelope.

3 • Basic Operation

Loading the DI950 HCEF (continued)

Adjusting the HCEF Separator Gap

NOTE: You must adjust the HCEF Wedge before you can adjust the Separator Gap. Refer to *Adjusting the HCEF Wedge* in this chapter for more information.

1. Prepare an envelope for the separator gap adjustment:
 - a. Cut a strip of 20 lb. (75 gsm) paper to fit inside an envelope.
 - b. Insert the strip of paper into the envelope.
-

NOTE: Tap the envelope lightly against a hard surface to ensure the strip of paper rests all the way down at the bottom of the envelope.

- c. Close the envelope flap.
2. Push up on the Separator Gap Lever to raise the Separator.



Figure 3.8.1: Push up on the Separator Gap Lever



Figure 3.8.2: Separator, Raised.

Loading the DI950 HCEF (continued)

- Place the envelope, bottom edge first, into the Separator so the top edge (flap crease) lines up with the edge of the tab on the Wedge.

NOTE: The edge of the tab is indicated by two arrows.

- Lower the Separator completely, then push down on the Separator Gap Lever to lock it into place.
- Pull the envelope out from the HCEF.

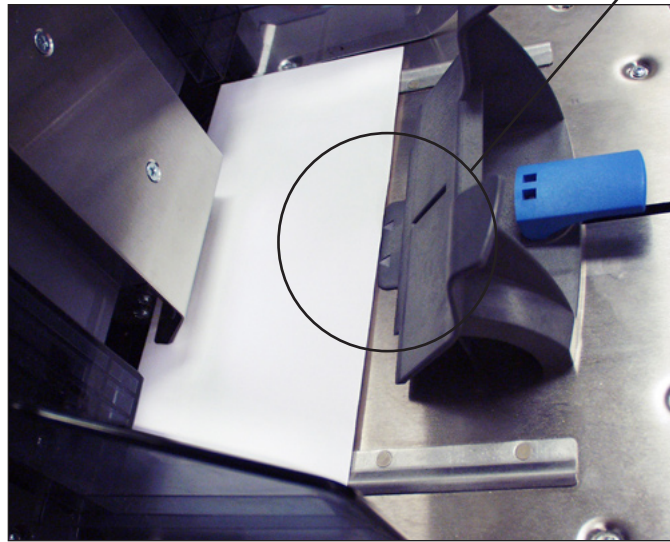

Figure 3.8.3: Envelopes Lined Up with Tab on Wedge.

- Shingle a 20mm to 50mm stack of envelopes. Place the envelopes into the HCEF flap side down, flap last.
- Finish loading a full stack of envelopes (up to 500 pieces), making sure that the envelopes contact the back of the Side Guides. It is not necessary to shingle the remaining envelopes.

NOTES:

- If an HCSF or Attached Printer is present, you may need to adjust guides to ensure sheets feed correctly. Refer to *Adjusting the HCSF Guides* or *Adjusting the Printer Interface Guides* in Chapter 7 of this guide for more information.
- If you are using scanning, you may need to adjust the scan head to ensure the bar code or OMR mark is read. Refer to *Adjusting the Scan Heads* in Chapter 8 of this guide for more information.

3 • Basic Operation

Making Pre-Run Adjustments

Once you have loaded the items for the selected job, you may need to make some envelope opener adjustments to ensure job accuracy.

Adjusting the Envelope Openers

The Envelope Openers in the Insertion Area open each envelope to allow insertion of the contents. If you are using a different size envelope than the previous job, you need to confirm that the envelope aligns properly with the Openers before running the new job. If the alignment is incorrect, you need to adjust the position of the Envelope Openers. Follow the steps in this section below to verify envelope alignment and to make adjustments.

Feed a Test Envelope

1. Load the outer envelopes into the envelope feeder(s).
2. Select "Loading Instructions" from the Home screen, and then select "Pre-Run Adjustments", and finally select "Envelope Opener Settings".

NOTE: The system will automatically select the Feeder when only one outer envelope is being used. If multiple outer envelopes are to be used, you need to select an envelope Feeder.

3. Press TRIAL PIECE to feed one envelope to the Insertion Area.
4. Open the Insertion Area Cover and observe the Envelope. If you need to make adjustments, follow the procedures for setting the width and/or length, as stated next.

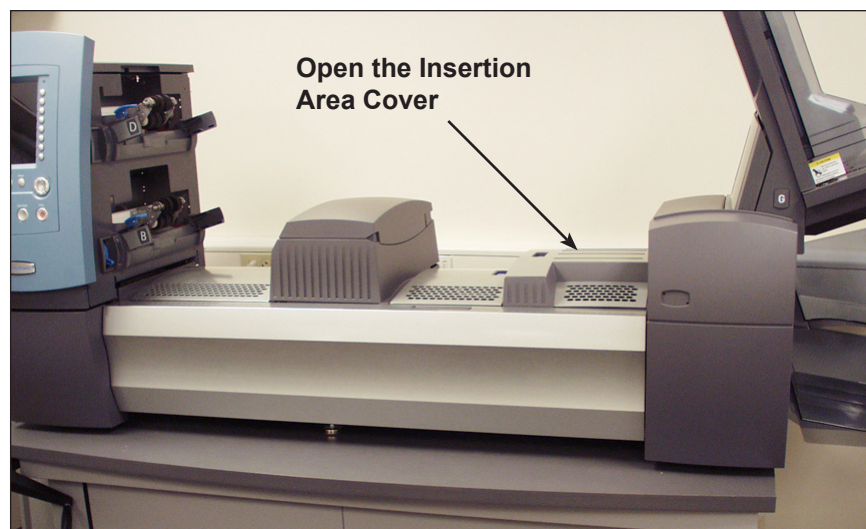

Figure 3.9.1: Insertion Area Cover

**Adjusting
the Envelope
Openers
(continued)**

Perform Width Adjustments (Outer Envelope Openers)

1. Loosen the thumbscrews on the top of the Outer Envelope Openers.

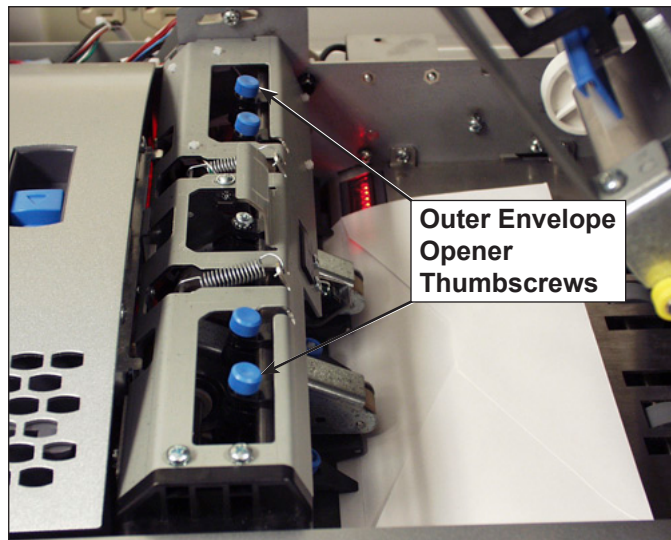

Figure 3.9.2: Outer Envelope Opener Locations

2. Slide the Openers as required to align the pointers with the outer edges of the envelope.
 - Push down on the thumbscrews to ensure the Outer Envelope Openers align with the envelope.
 - If using small envelopes (less than 194mm wide), move the Outer Envelope Openers out and away from the outer edges of the envelope.
 - If using windowed envelopes, ensure the Outer Envelope Openers do not touch the edges of the window.

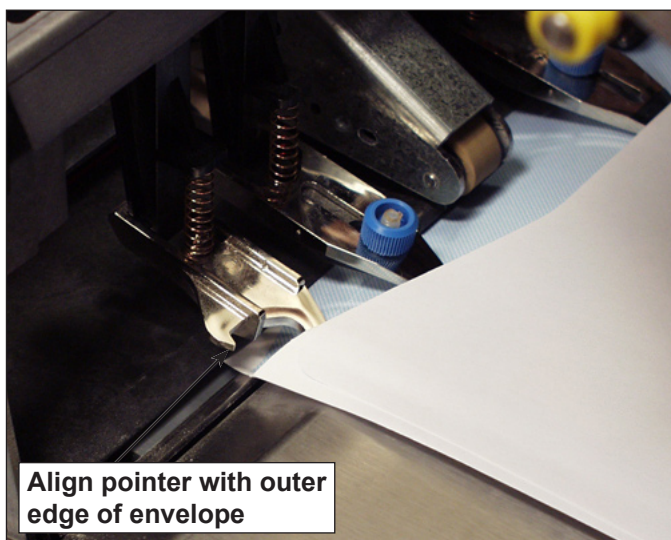

Figure 3.9.3: Aligning the Outer Envelope Opener

3. Tighten the thumbscrew on the top of the Outer Envelope Openers.

3 • Basic Operation

Adjusting the Envelope Openers (continued)

Perform Length Adjustments (Inner Envelope Openers)

1. If using windowed envelopes, loosen the thumbscrews that secure each Inner Envelope Opener.

NOTE: There are three Inner Envelope Openers, that typically need length adjustments only. But, when needed, these (except the Middle Opener) can be moved laterally.

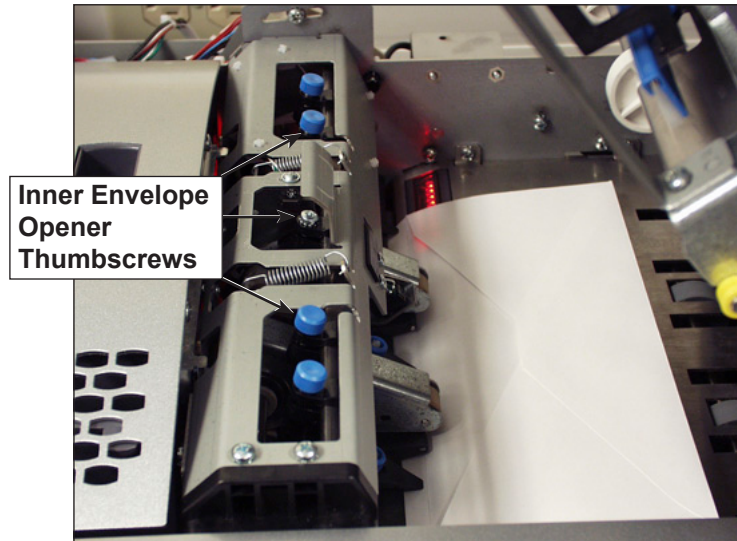

Figure 3.9.4: Inner Envelope Opener Locations

- a. Position the Inner Envelope Openers so they do not touch the edge of the window. In unusual circumstances, i.e., vertical windows, it may be necessary to place the Opener on the window to prevent the Opener from catching on the window's edge.
 - b. Tighten the thumbscrews for the adjusted Openers.
2. Press down then pull one of the knobs on the top of the frame to determine how far the the insertion edge of one Inner Envelope Opener goes into the envelope.

**Adjusting
the Envelope
Openers
(continued)**

3. If necessary, loosen the knob on the insertion edge of the Inner Envelope Opener, and adjust until it goes *at least* 5 mm into the top panel of the envelope.

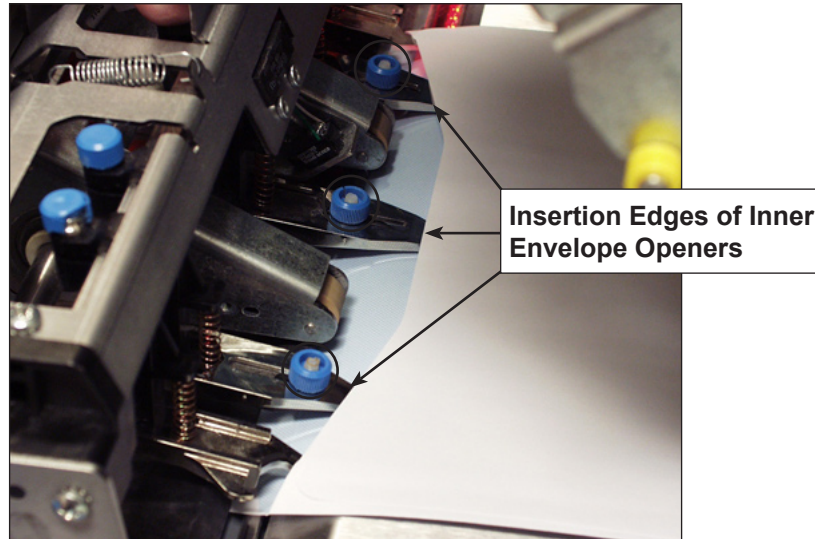

Figure 3.9.5: Inner Envelope Openers Inserted into Envelope

4. Tighten the knob for the adjusted insertion edge.
5. Repeat steps 2 through 4 for the other two insertion edges.

Verify Settings

When you finish making the necessary Envelope Opener adjustments, close the Insertion Area Cover, then verify your settings by doing the following:

1. Press CLEAR DECK.
2. Press TRIAL PIECE.
 - If the Envelope Openers are positioned correctly (that is, aligned correctly to open the envelope), select "OK".
 - If more adjustments are needed, repeat the steps stated in the previous sections until proper alignment is achieved.

NOTE: Each time you press TRIAL PIECE, a complete Trial Piece will be generated.

3 • Basic Operation

Running a Trial Piece

Once the job setup is completed, you must run a trial piece to ensure system function and to verify the accuracy of your final mail piece. Follow these steps to run a trial piece:

1. Attach the Feeder Trays to the Feeder Tower. Refer to earlier sections in this chapter for specific instructions.

NOTE: Highlight the Mail Piece Tree Icons on the Home screen for information on the Tray type to use, orientation of the material in the Tray, and location of the Tray on the Feeder Tower.

2. Load the mail piece components into the Feeder Trays.
3. Press TRIAL PIECE. The system collates all contents of the mail piece according to the job parameters. The resulting mail piece is fed to the Upper Divert Area waiting for your inspection. It does not go through the Sealer. The Trial Piece Complete screen will display.
4. Examine the mail piece:
 - a. Remove the contents from the outer envelope.
 - b. Make sure the items are collated in the desired order and that the destination address displays correctly, in the case of a windowed enveloped.
 - c. Check for doubles.

Running a Trial Piece (continued)

5. Depending on your findings, choose one of the following options listed on the Trial Piece screen:
 - a. If the trial mail piece passes inspection, select "Trial Piece OK". You will be returned to the Home screen, or press START to begin the job.
 - b. If the address needs to be moved UP/DOWN (applies to Windowed envelopes), select "Adjust Address". The following screen will appear.

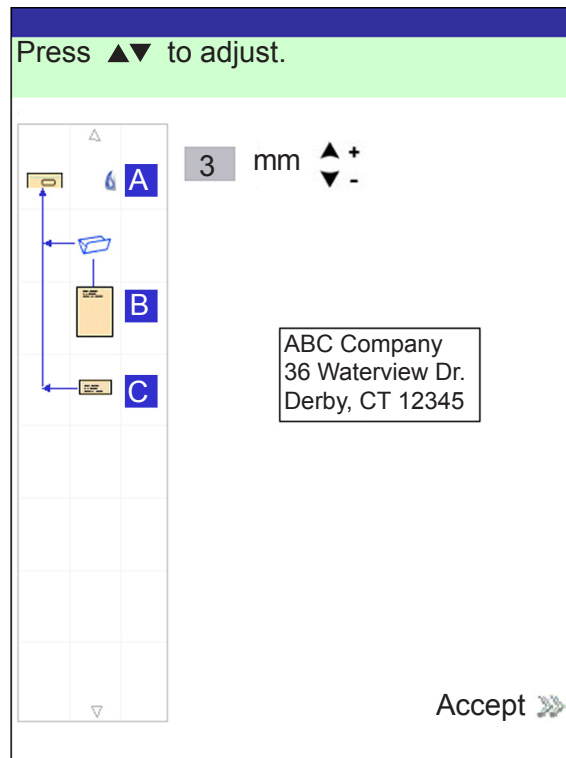

Adjust Address Screen

- Use the UP/DOWN keys to re-position the address, and then select "Finished". You will be returned to the Home screen.
- c. If you want to make other adjustments, select "Edit Job". You will now be able to add, delete, or move mail piece components and to change parameters for a document(s) in the mail piece.

NOTES:

- Detailed instructions on use of the Add, Delete, Move, and Edit functions are contained in later sections of this chapter.
 - If you make any changes to the mail piece order, address position and/or to a document(s) in the mail piece, run Trial Piece again to verify machine function and mail piece accuracy.
 - Any edits you make are NOT saved unless a Supervisor/Manager specifically saves them.
- d. If you need to check/verify the job settings, access the Review Job screen (select "Home", then select "Menu", "Jobs" and finally "Review Job").

3 • Basic Operation

Reviewing the Job Settings

You may want to review the job settings before you start running the job. The Review Job screen provides an at-a-glance view of the settings for each of the mail piece component parameters and the general job settings. This screen is a time efficient way to make sure that you have selected the correct job.

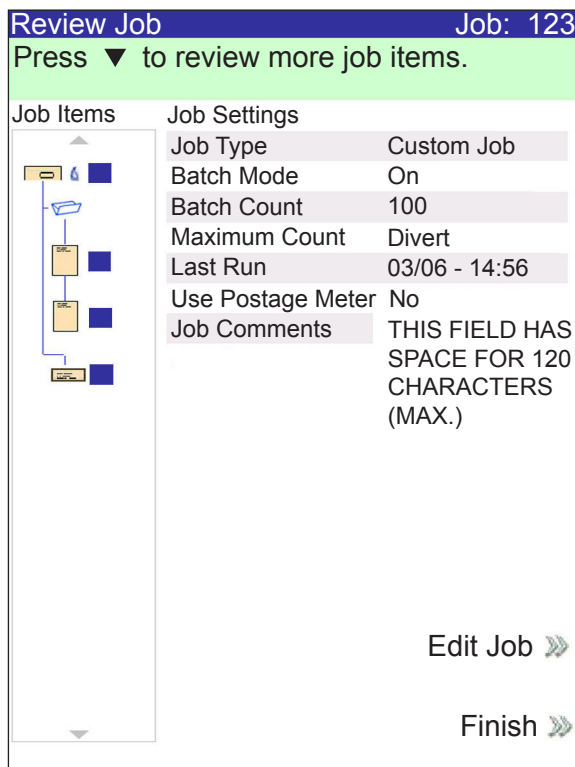

Review Job Screen

To access the Review Job screen:

1. From the Home screen, select "Menu".
2. From the Menu screen, select "Jobs", then "Review Current Job".
3. Use the Arrow Keys to scroll through the settings for the job and each of the included items.
 - Select "Edit Job" to access screens for making changes.
 - Select "Finish" to return to the Menu screen.
 - Press HOME to return to the Home screen.

NOTE: Make sure that the materials in the mail piece meets material specifications. Refer to the Specifications listed in *Chapter 6*.

Starting the Job When your Trial Piece is verified, you are ready to start running the job. To do this:

1. Make sure that you are in the Home screen.
2. Press START. The system will begin running the job.

SwiftStart™ Jobs

SwiftStart™ mode allows you to run a simple job without entering any setup information. In SwiftStart™ mode, the system automatically senses the material and sets the required parameters for running the job. A SwiftStart™ job can be run without saving the settings, or a Supervisor/Manager can name and save the job for future recall and use.

Use SwiftStart™ when your mail piece consists of only a small number of sheets of one size that can be folded.

- A single sheet and a single insert will be taken from each loaded feeder, giving a maximum mail piece content of: four sheets and three inserts (DI900) or four sheets and four inserts (DI950). Fold will be determined by sheet length and envelope depth.

NOTE: The maximum content options are available only when two HCSFs are present.

- Maximum sheet length is 11-5/8" (297 mm)
- Only envelope depths of 4-1/4" to 6-3/8" (109 mm, 111 mm, 114 mm, 121 mm and 162 mm) can be used.
- Cannot be used to run fold only or inserts only.
- Cannot link feeders in this mode.
- Envelope sealer is always on (except on trial piece).
- Batch count is always off.
- This mode will not work with scanning.
- Address should be at the top of the sheet.

3 • Basic Operation

Using SwiftStart™ To use SwiftStart™:

1. Select "SwiftStart" from the Home screen.
2. Attach and load Feeder Trays:
 - a. Load the outer envelopes in Insert Tray (A) or in the HCEF (G, if present on system).
 - b. Load sheets and then inserts, starting with the feeder farthest to the left and on the bottom.
 - c. Load the remaining sheets and/or inserts clockwise and to the right of the first item.
3. Press TRIAL PIECE. The system feeds one envelope from the Insert Tray or HCEF (if present), and measures its length. Then, it feeds a sheet from the Sheet Tray and measures its length. The system does some internal calculations with these measurements and from them determines the fold type for the control document.

The system then repeats the measuring and fold determination procedure for each sheet and insert, creating a Mail Piece Icon Tree in the process to represent this job.

When all items from loaded Trays/Feeders have been fed, the system produces a sample mail piece.
4. Check the trial piece, and then make any needed adjustments. Repeat the trial piece run until the mail piece meets your specifications.
5. Press START to run your job.
6. If you wish to save this job, you will need supervisor or manager access to enter a name in the save job screen.

Creating a Job

Creating a new job involves defining the contents of a new mail piece, and optionally, saving the job for future use. This process consists of identifying each item in the mail piece and selecting settings for the job. A Mail Piece Icon Tree automatically builds on the screen as you add items.

To access the Create New Job screen:

1. From the Home screen, select "Menu", then "Jobs", and finally "Create New Job." The Create Job screen displays.
2. Enter the Job Name using the alphanumeric matrix.
 - a. Use the UP/DOWN and LEFT/RIGHT arrow keys to select a letter.
 - b. Press OK to add the letter to the job name. Highlight the arrow character and press OK to move the cursor within the job name.
 - c. Select "Accept Name" when done.

**Creating a Job
(continued)**

3. If scanning is present on the system, the Create - Job Type screen displays.
 - If the new job does not require scanning, select "Normal Type" to continue.
 - If the new job requires scanning, select "Scanning Job".
4. The Create Outer Envelope screen displays.
 - If the job does not require an Outer Envelope, select "No".
 - If the job requires an Outer Envelope, select "Yes."
 - Select the appropriate Outer Envelope options for the job. Refer to the *Envelope Options* table in this chapter for more information about each of the related menu options.
 - Press "Accept" when done.
 - If the job is a scanning job, the Create - Only One Envelope screen displays. If the job requires only one envelope, select "Yes" and proceed to step 5.
If the job requires an additional envelope, select "No, Two Outer Envelopes". Validate the available options, and press "Accept" when done.

NOTE: If this is a scanning job, and you will be using dynamic envelope selection, you must select "No, Two Outer Envelopes".

5. The Create - Select Next Item screen displays. Select the appropriate option.

Menu Options	Associated Options/Actions
Reply Card Reply Envelope Pre-Folded Insert Small Booklet Slip Generic Insert Large Booklet	a. If this is a scanning job, follow the steps below. Otherwise, go to step b. <ul style="list-style-type: none"> • The Scan Type screen displays. Select the appropriate Scan Type (OMR, Code 3 of 9, or Interleaved 2 of 5.) • The Scan Configuration screen displays. Select the appropriate Scan Configuration. • The Content - In Line with Marks screen displays. <i>If there is content in line with the scan marks, select "Yes". If there is no content in line with the scan marks, select "No".</i> b. Select the appropriate options for the insert. Press "Accept" when done. Refer to the <i>Insert Options</i> table in this chapter for specific information about each of the related menu options.

3 • Basic Operation

Creating a Job (continued)

Menu Options	Associated Options/Actions
Sheet (continued)	<p>a. Follow the appropriate step below:</p> <ul style="list-style-type: none"> • <i>If this is the first sheet you are adding to the job and the Attached Printer is not present</i> select the appropriate personalization option. The Create - Verify Sheet screen appears. • <i>If this is the second sheet you are adding to the job</i> select either "Same Set (Fold with previous sheet)" or "New Set (Fold separately.)" If the sheet is part of a new set, select the appropriate personalization option. • <i>If this is the first sheet you are adding to the job and the Attached Printer is present</i> select the appropriate printer option. The Sheet - Personalized Create screen appears. Select the appropriate personalization option. The Create - Verify Sheet screen appears. <p>b. If this is a scanning job, follow the steps below. Otherwise, go to step c.</p> <ul style="list-style-type: none"> • The Scan Type screen displays. Select the appropriate Scan Type (OMR, Code 3 of 9, or Interleaved 2 of 5.) • The Scan Configuration screen displays. Select the appropriate Scan Configuration. • The Content in Line with Marks screen displays. <i>If there is content in line with the scan marks</i>, select "Yes". <i>If there is no content in line with the scan marks</i>, select "No". • If you selected "Yes", the Mark Locations Settings screen appears. Follow the steps below to enter the various mark-related measurements: <ul style="list-style-type: none"> - Select an option, then use the UP/DOWN arrow keys to enter the appropriate measurement (in millimeters). - Press "Accept" when done entering the measurement. - Once <i>all</i> measurements have been entered, select "Accept". <p>c. Select the appropriate Sheet options for the job. Press "Accept" when done.</p> <p>NOTE: If this is a scan job, be sure to set the Select Feed setting.</p> <p>Refer to the <i>Sheet Options</i> table in this chapter for more information about each of the related menu options.</p> <p>d. Select the appropriate Fold options for the sheet. Press "Accept" when done.</p> <p>Refer to the <i>Fold Options</i> table in this chapter for specific information about each of the related menu items.</p>

6. Once you have finished adding a Sheet or Insert, the Add New Item screen appears.
 - Select "Yes" to add additional items to the job. Repeat step 4 as necessary.
 - Select "No" if you have finished adding items to the job.
7. The Create - Edit Job Settings screen displays. Select the appropriate options.

**Creating a Job
(continued)**

Menu Options	Associated Options/Actions
Job Comments	<p>Use the alphanumeric matrix to enter any additional information related to the job. If the job will be saved by a supervisor or manager, you can make it easy for operators to identify/select the correct job in the future by entering a job description in the job comments area.</p> <p>NOTE: Job comments can contain up to 120 characters.</p>
Batch Mode	<p>Toggle:</p> <ul style="list-style-type: none"> • <i>Off</i> means this feature will not function for this job, or • <i>On</i> means this feature is active. <p>NOTE: Batch mode cannot be used with scanning jobs.</p>
Batch Count	<p>Use the numeric matrix to enter the batch count value.</p> <p>NOTE: The batch count can contain up to four digits. The minimum is "5" and the maximum is "9999".</p>
Set Over Max Count	<p>Indicates what will happen to sets that exceed the set over count quantity. Choices include <i>Divert</i> and <i>Stop</i>.</p>
Use Postage Meter	<p>Select this option if you will be using the Mail Machine Interface (MMI). This interface enables communication between the Inserting System and either a DM Series™ DM800i™ or DM1000™ mailing system via a USB connection.</p> <p>The system sends start and stop signals to the mailing system, and the mailing system can send error messages back to the inserter to stop feeding.</p> <p>Toggle:</p> <ul style="list-style-type: none"> • <i>Off</i> means this feature will not function for this job, or • <i>On</i> means this feature is active. <p>NOTE: The MMI is a purchasable exit option. Only letter-sized envelopes can be used with this interface.</p> <p>Refer to <i>DM Series™ Mailing System Interface (DM800i™ or DM1000™ only)</i> in <i>Chapter 7</i> for more information about the MMI.</p>
Advanced	<p>Allows access to advanced job settings.</p> <p>IMPORTANT: Do not change the advanced job settings unless instructed to do so. Changing settings may affect machine performance.</p>

8. Select "Accept" when done.
9. The Create - Saved Created Job screen displays.
 - Select "Yes, Save" to save the job (optional). You must have supervisor or manager access rights to save jobs.
 - Select "No, Save Later" if you do not have supervisor or manager access rights.

3 • Basic Operation

Job Options

This section contains descriptions of the various options you can add or modify when creating or editing a job.

Envelope Options

Menu Item	Associated Options and Actions
Name	Use the alphanumeric matrix to enter the envelope name.
Size refers specifically to the outer envelope that contains the final mail piece.	Toggle: <ul style="list-style-type: none"> • <i>Letter</i> generally has smaller depth and contains folded sheets, or • <i>Flat</i> generally is larger than Letter size and typically contains unfolded sheets. Refer to <i>Envelopes</i> in <i>Chapter 6</i> for specification information.
Window allows use of windowed or non-windowed envelope.	Toggle: <ul style="list-style-type: none"> • <i>Yes</i> means you are using a windowed envelope, or • <i>No</i> means you are using a non-windowed envelope.
Type allows choice of windowed envelope.	<ul style="list-style-type: none"> • <i>Standard Flap</i> is a regular envelope. • <i>Forward Flap</i> means the window and flap are on the same side of the envelope. • <i>Bottom Flap</i> means the flap is at the bottom (instead of the top) of the envelope.
Seal refers to using the Moistener unit to close the envelope.	<ul style="list-style-type: none"> • <i>Off</i> means the envelope will not be sealed closed, or • <i>On</i> means the envelope will be sealed closed. • <i>Safe Seal</i> means the envelope will be sealed closed. However, the envelope moves through the system at a slower rate to provide more time for better sealing. This option is available only for flat envelopes, when the Flats Sealer is present on the system. <p>NOTE: If you are using a mailing machine in-line with the inserting system, you <i>must</i> instruct the system to seal the envelope.</p>
Depth is the dimension of an envelope from its flap fold to its opposite edge.	<ul style="list-style-type: none"> • <i>Auto Measure</i> - system measures depth when envelope is fed. • <i>Custom Depth</i> - allows you to enter the depth of the envelope. • Letter Options: #10 - 105mm, #6 ¾ - 165mm, C5 - 162mm, C6 - 114mm. Flat Options: #12 ½ - 317mm, C4 - 229mm.

**Envelope
Options
(continued)**





Menu Item	Associated Options and Actions
<p>Additional Settings</p>	<p>Double Detect allows the system sense when multiple envelopes are fed unintentionally.</p> <ul style="list-style-type: none"> • <i>Double Detect Feature</i> allows you to toggle: <ul style="list-style-type: none"> - <i>Off</i> means this feature will not function for this item, or - <i>On</i> means this feature is active. • <i>Location</i> allows you to toggle: <ul style="list-style-type: none"> - <i>Default</i>, or - <i>Custom</i>. • <i>Custom Location for Top Edge</i> allows you to enter a specific measurement (distance from the edge feeding first into the feeder) where the system should attempt to detect a double. Set this option when Location is set to "Custom". <ul style="list-style-type: none"> - Use the UP/DOWN arrow keys to adjust the measurement (in millimeters). - Select "Accept" when you are done. <p>NOTE: The double detect region cannot be within 25 mm of the lead or trail edges of the envelope.</p> <p><i>If the envelope is feeding from the HCEF, measure from the bottom of the envelope.</i></p> <p><i>If the envelope is feeding from the Feeder Tower, measure from the top of the envelope. The custom location must be at least 5 mm away from the edge of the window (if present), at least 5 mm away from the edge of flap, and cannot lie on top of a seam.</i></p> <p><i>For best results, be sure to avoid areas that overlap with the window, flap, or seams.</i></p> • <i>Action On Double</i> allows you to select where the items should be fed to if a double is detected.
	<p>Feeder Type allows you to change the Feeder setting when material is problematic.</p> <ul style="list-style-type: none"> • <i>Normal</i> is used for most items. • <i>Special Feeder</i> helps problematic material run better. <p>NOTE: The Special Feeder is a purchasable option. If available, it will be located at the top left or right of the Feeder Tower. It is an option for one or more tower feeders to improve feeding of thin prefolded items or booklets with thin covers. It reduces the tendency of these items to separate while they are being fed. You must push the "Special Feeder" lever up to run a job when the Feeder Type is set to Special Feeder.</p>
	<p>Feeder Linking allows multiple Feeders to feed the same envelope.</p> <ul style="list-style-type: none"> • <i>None</i> means there is no linking of Feeder Trays. • <i>Two Feeders</i> indicates that two Feeder Trays are linked and feeding the same material. <p>NOTE: Feeders must be on the same module and on the same side of the tower to be linked. For scanned items, always load linked feeders at a collation break.</p>

3 • Basic Operation

Envelope Options (continued)

Menu Item	Associated Options and Actions
Additional Settings (continued)	<p>Envelope Select Feed allows you to indicate when the envelope should be used.</p> <p>Toggle:</p> <ul style="list-style-type: none"> • <i>Main</i> • <i>Alternate</i> <p>NOTE: This option is enabled only when the Scan feature is activated, two Outer Envelopes have been defined in a job <i>and</i> either one of the following:</p> <ul style="list-style-type: none"> • The Item Over Count Action is set to “Use Alternate Envelope” on the control document in the job, OR • An Envelope Select mark is contained in the scan configuration file associated with the control document in the job.

Fold Options

Menu Item	Associated Options and Actions
Fold Type refers to the way sheets are folded to be able to show certain portions through a window, and/or when a sheet is opened.	<ul style="list-style-type: none"> • <i>C Fold</i>  • <i>Z Fold</i>  • <i>Single Fold</i>  • <i>Double Fold</i>  • <i>No Fold</i> 
Auto Fold Lengths lets the system choose the type of fold.	<p>Toggle:</p> <ul style="list-style-type: none"> • <i>Yes</i> means the system calculates the fold length, or • <i>No</i> means you will enter the fold lengths you want.
Fold 1 Length Fold 2 Length	<p>Fold Length is shown on the display screen for each fold type/address combination.</p> <ul style="list-style-type: none"> • Use the UP/DOWN Arrow Keys to select desired length. • Press "Accept" when done.

Sheet Options

Menu Item	Associated Options and Actions
Name	Use the alphanumeric matrix to enter the job name.
Control Document is the top sheet in the Mail Piece Icon Tree. This field is read-only.	Read-Only field <ul style="list-style-type: none"> • Yes, or • No
Type identifies the printing source of the job.	<ul style="list-style-type: none"> • <i>Printed Separately</i> - indicates the sheet is not printed by the Attached Printer. • <i>Printed by Attached Printer</i> - indicates the sheet is printed by the Attached Printer. <p>NOTE: This menu option is available only with configurations that contain an Attached Printer. If an Attached Printer is not present, this option appears as a read-only field with “Printed Separately” as the default setting.</p>
Personalized refers to the top sheet that contains the address that will show in the windowed envelope and/or a sheet that contains information customized to a specific recipient.	<ul style="list-style-type: none"> • <i>Top Address</i> • <i>Middle Address</i> • <i>Bottom Address</i> • <i>Not Personalized</i> • <i>Personalized - No Address</i>
Quantity is the number of this type of sheet to include in each mail piece.	<ul style="list-style-type: none"> • 1, 2, 3, 4, 5, 6 • <i>Custom Quantity</i> <ul style="list-style-type: none"> - Use UP/DOWN arrows to select number. - Select "Accept" when done. <p>NOTE: Quantity is always set to Variable (n) for scanning jobs.</p>
Page Order identifies the feeding pattern of multiple sheets that are not identical.	<p><i>Forward</i> - indicates page 1 is on top and pages 2, 3, 4, etc. follow in that order.</p> <p><i>Reverse</i> - indicates that the last page, for example, page 4, is first followed by pages 3, then 2, then 1.</p> <p>NOTE: This menu option appears as a read-only field when the job requires a Custom Feeder. The feeding pattern is set by the Custom Feeder.</p>
Length is the dimension of the sheet in the direction of the feed.	<ul style="list-style-type: none"> • <i>Auto measure</i> - measures the recommended length automatically. <p>NOTE: This menu option appears as a read-only field when the job requires a Custom Feeder.</p> <ul style="list-style-type: none"> • <i>Custom Length</i> - allows increase or decrease of sheet length. <ul style="list-style-type: none"> - Use UP/DOWN arrows to select number. - Select "Accept" when done. • <i>Letter - 279mm, Legal - 356mm, and A4 - 279mm</i> are additional options. <p>NOTE: The “Legal” option is not available when the sheet is printed by the Attached Printer. Additionally, legal-sized documents cannot be fed from the High Capacity Sheet Feeder. The system will assign these documents to a Tower Feeder, even when the High Capacity Sheet Feeder is available.</p>

3 • Basic Operation

Sheet Options (continued)

Menu Item	Associated Options and Actions
Additional Settings.	<p>Double Detect allows the system to sense when multiple sheets are fed unintentionally.</p> <p>NOTE: This menu option is not available when the job requires a Custom Feeder.</p> <ul style="list-style-type: none"> • <i>Double Detect Feature</i> allows you to toggle: <ul style="list-style-type: none"> - <i>Off</i> means this feature will not function for this item, or - <i>On</i> means this feature is active. • <i>Location</i> allows you to toggle: <ul style="list-style-type: none"> - <i>Default</i>, or - <i>Custom</i>. • <i>Custom Location for Top Edge</i> allows you to enter a specific measurement (the distance from the edge feeding first into the feeder) where the system should attempt to detect a double. <p>NOTE: Set this option when Location is set to "Custom". The double detect region cannot be within 25 mm of the lead or trail edges of the sheet.</p> <ul style="list-style-type: none"> - Use the UP/DOWN arrow keys to adjust the measurement (in millimeters). - Select "Accept" when you are done. • <i>Action On Double</i> allows you to select where the items should be fed to if a double is detected.
	<p>Feeder Type allows you to change the Feeder setting when material is problematic, or to indicate that the job requires a Custom Feeder.</p> <p>NOTE: This menu option is not available when the job requires an Attached Printer.</p> <ul style="list-style-type: none"> • <i>Normal</i> is used for most items. • <i>Manual Feed</i> is used when items will be fed into the system by hand. Refer to <i>Manual Feeder</i> in <i>Chapter 2</i> for more information. • <i>Custom Feeder</i> is used when items will be fed into the system by the Custom Feeder.
	<p>Feeder Linking allows multiple Feeders to feed the same material.</p> <p>NOTE: This menu option is not available when the job requires a Custom Feeder or an Attached Printer.</p> <ul style="list-style-type: none"> • <i>None</i> means there is no linking of Feeder Trays. • <i>Two Feeders</i> indicates that two Feeder Trays are linked and feeding the same material. <p>NOTE: Scanned sheets can be linked vertically in both the High Capacity Sheet Feeder and the Feeder Tower.</p>
	<p>Scan Items allows you to indicate whether or not an item should be scanned.</p> <p>Toggle:</p> <ul style="list-style-type: none"> • <i>Yes</i> means this feature is active, or • <i>No</i> means this feature will not function for the item.

Sheet Options
(continued)

Menu Item	Associated Options and Actions
<p>Additional Settings (continued)</p>	<p>Scan Settings</p> <p>NOTE: The “Content in Line with Marks”, “Marks On”, “Marks on First Page Only”, and “Mark Location Settings” options are not available when the job requires a Custom Feeder.</p> <ul style="list-style-type: none"> • <i>Scan Configuration</i> allows a choice of saved scan configurations to interpret scan marks. • <i>Content in Line with Marks</i> indicates that content is in line with the scan marks in the feed direction. • <i>Marks On</i> indicates if marks are on the front or back of the page. • <i>Marks on First Page Only</i> indicates marks are on only the first of multiple sheets. • <i>Mark Location Settings</i> allows setup of various mark-related measurements. <ul style="list-style-type: none"> - <i>Top of Page to First Mark</i> is the distance from the top of the page to the first mark. - <i>Total Length of Marks</i> is the length from the top of the first possible mark to the bottom of the last mark. - <i>Top of Page to Clear Zone</i> is distance from the top of the page to the beginning of the Clear Zone. - <i>Length of Clear Zone</i> is the distance from the top of the Clear Zone to the first mark. <p>Refer to <i>OMR Specifications</i> in <i>Chapter 8</i> for more information on the Clear Zone and mark location settings.</p> <ul style="list-style-type: none"> • <i>Item Over Count Quantity</i> is the number of sheets to be accumulated before the system takes an alternate action. • <i>Item Over Count Action</i> indicates what will happen to items that exceed the item over count quantity. Choices include: <ul style="list-style-type: none"> - <i>Divert</i> – Select this option if the Scan Configuration does not have the Divert Sheet (DVS) scan mark, and you want the system to divert items once the item over count quantity has been exceeded. - <i>Stop</i> - Select this option if you want the system to stop processing items once the item over count quantity has been exceeded. - <i>Use Alternate Envelope</i> – Select this option if the Scan Configuration does not have the Envelope Select (ES) scan mark, and you want the system to use an alternate envelope for items that exceed the item overcount quantity. <p>Refer to <i>Scanning Features</i> in <i>Chapter 8</i> for more information on dynamic envelope selection and divert sheet functionality.</p> <p>Select Feed (SF) Settings allows assignment of a Feeder to one of the 9 Select Feed scan marks.</p> <p>NOTE: This menu option is not available when the item requires an Attached Printer or Custom Feeder (when a High Capacity Sheet Feeder is part of the configuration).</p>

3 • Basic Operation

Insert Options

Menu Item	Associated Options and Actions
Name	Use the alphanumeric matrix to enter the job name.
Insert Type includes all items that do not need folding or have been pre-folded.	<ul style="list-style-type: none"> • <i>Reply Envelope</i> - is also called a Business Reply Envelope. • <i>Reply Card</i> - is a thick slip. • <i>Pre-folded Insert</i> - is a sheet or set of sheets already folded together. • <i>Small Booklet</i> - is a type of insert that typically has a bound or stapled edge. • <i>Slip</i> - is single thickness document that fits into the outer envelope without folding. • <i>Generic</i> - is an undeclared type of insert used by SwiftStart™ jobs. • <i>Large Booklet</i> - is a type of insert that typically has a bound or stapled edge.
Personalized means the insert contains information customized to a specific recipient. NOTE: This menu option is not available when "Large Booklet" is the selected insert.	Yes means there <u>is</u> unique information on this insert, or No means the insert does <u>not</u> contain unique information.
Quantity is the number of this particular insert to include in each mail piece. NOTE: This menu option is not available when "Large Booklet" is the selected insert.	<ul style="list-style-type: none"> • 1, 2, 3, 4, 5, 6 • <i>Custom Quantity</i> <ul style="list-style-type: none"> - Use UP/DOWN arrow keys to select number. - Select "Accept" when done. • <i>Variable</i> - used with scanning-controlled jobs. NOTE: At this time, only a single insert can be added to each mail piece. When using a flat envelope, the insert must be a Reply Envelope (BRE).
Page Order identifies the feeding pattern of multiple inserts that are not identical. NOTE: This menu option is not available when "Large Booklet" is the selected insert.	<i>Forward</i> - indicates page 1 is on top and pages 2, 3, 4, etc. follow in that order. <i>Reverse</i> - indicates that the last page, for example, page 4, is first followed by pages 3, then 2, then 1.
Length is the dimension of the insert in the direction of the feed.	<ul style="list-style-type: none"> • <i>Auto measure</i> - measures the recommended length automatically. NOTE: Auto measure is not available when "Large Booklet" is the selected insert or when the job requires a Custom Feeder. • <i>Custom Length</i> - allows increase or decrease of insert length. <ul style="list-style-type: none"> - Use the UP/DOWN Arrow Keys to select number. - Select "Accept" when done. • <i>Custom Length (Large Booklet Only)</i> - allows selection of large booklet size: 8.5" x 11" or 5.5" x 8.5".

**Insert Options
(continued)**

Menu Item	Associated Options and Actions
<p>Additional Settings</p>	<p>Double Detect allows the system sense when multiple inserts are fed unintentionally.</p> <p>NOTE: This menu option is not available when the job requires a Custom Feeder.</p> <ul style="list-style-type: none"> • <i>Double Detect Feature</i> allows you to toggle: <ul style="list-style-type: none"> - <i>Off</i> means this feature will not function for this item, or - <i>On</i> means this feature is active. • <i>Location</i> allows you to toggle: <ul style="list-style-type: none"> - <i>Default</i>, or - <i>Custom</i>. • <i>Custom Location for Top Edge</i> allows you to enter a specific measurement (the distance from the edge feeding first into the feeder) where the system should attempt to detect a double. <p>NOTE: Set this option when Location is set to "Custom". The double detect region cannot be within 25 mm of the lead or trail edges of the insert.</p> <ul style="list-style-type: none"> - Use the UP/DOWN arrow keys to adjust the measurement (in millimeters). - Select "Accept" when you are done. • <i>Action On Double</i> allows you to select where the items should be fed to if a double is detected.
	<p>Feeder Type allows you to change the Feeder setting when material is problematic, or to indicate that the job requires a Custom Feeder.</p> <p>NOTE: This menu option is not available when the job requires an Attached Printer.</p> <ul style="list-style-type: none"> • <i>Normal</i> is used for most items. • <i>Manual Feed</i> is used when items will be fed into the system by hand. Refer to <i>Manual Feeder</i> in <i>Chapter 2</i> for more information. • <i>Custom Feeder</i> is used when items will be fed into the system by the Custom Feeder.
	<p>Feeder Linking allows multiple Feeders to feed the same material.</p> <p>NOTE: This menu option is not available when the job requires a Custom Feeder.</p> <ul style="list-style-type: none"> • <i>None</i> means there is no linking of Feeder Trays. • <i>Two Feeders</i> indicates that two Feeder Trays are linked and feeding the same material.
	<p>Scan Items allows you to indicate whether or not an item should be scanned.</p> <p>Toggle:</p> <ul style="list-style-type: none"> • <i>Yes</i> means this feature is active, or • <i>No</i> means this feature will not function for the item.

3 • Basic Operation

Insert Options (continued)

Menu Item	Associated Options and Actions
Additional Settings (continued)	<p>Scan Settings</p> <p>NOTE: The “Content in Line with Marks”, “Marks On”, “Marks on First Page Only”, and “Mark Location Settings” options are not available when the job requires a Custom Feeder.</p> <ul style="list-style-type: none"> • <i>Scan Configuration</i> allows choice of saved scan configurations to interpret scan marks. • <i>Content in Line with Marks</i> indicates that content is in line with the scan marks in the feed direction. • <i>Marks On</i> indicates if marks are on the front or back of the page. • <i>Marks on First Page Only</i> indicates marks are on only the first of multiple inserts. • <i>Mark Location Settings</i> allows setup of various mark-related measurements. <ul style="list-style-type: none"> - <i>Top of Page to First Mark</i> is the distance from the top of the page to the first mark. - <i>Total Length of Marks</i> is the length from the top of the first possible mark to the bottom of the last mark. - <i>Top of Page to Clear Zone</i> is distance from the top of the page to the beginning of the Clear Zone. - <i>Length of Clear Zone</i> is the distance from the top of the Clear Zone to the first mark. <p>Refer to <i>OMR Specifications</i> in <i>Chapter 8</i> for more information on the Clear Zone and mark location settings.</p> <ul style="list-style-type: none"> • <i>Item Over Count Quantity</i> is the number of inserts that cannot be run normally. <p>NOTE: At this time, only a single insert can be added to each mail piece. When using a flat envelope, the insert must be a Reply Envelope (BRE).</p> • <i>Item Over Count Action</i> indicates what will happen to items that exceed the item over count quantity. Choices include: <ul style="list-style-type: none"> - <i>Divert</i> - Select this option if the Scan Configuration does not have the Divert Sheet (DVS) scan mark, and you want the system to divert items once the item over count quantity has been exceeded. - <i>Stop</i> - Select this option if you want the system to stop processing items once the item over count quantity has been exceeded. <p>Refer to <i>Scanning Features</i> in <i>Chapter 8</i> for more information on divert sheet functionality.</p> <p>Select Feed (SF) Settings allows assignment of a Feeder to one of the 9 Select Feed scan marks.</p> <p>NOTE: This option is not available if the item requires a Custom Feeder and a High Capacity Sheet Feeder is part of the configuration.</p>

Editing a Job

Editing a job involves any or all of the following:

- Changing characteristics for a selected item.
- Adding an item to the mail piece.
- Deleting an item from the mail piece.
- Moving an item to a different position in the mail piece collation.
- Modifying settings for the job.

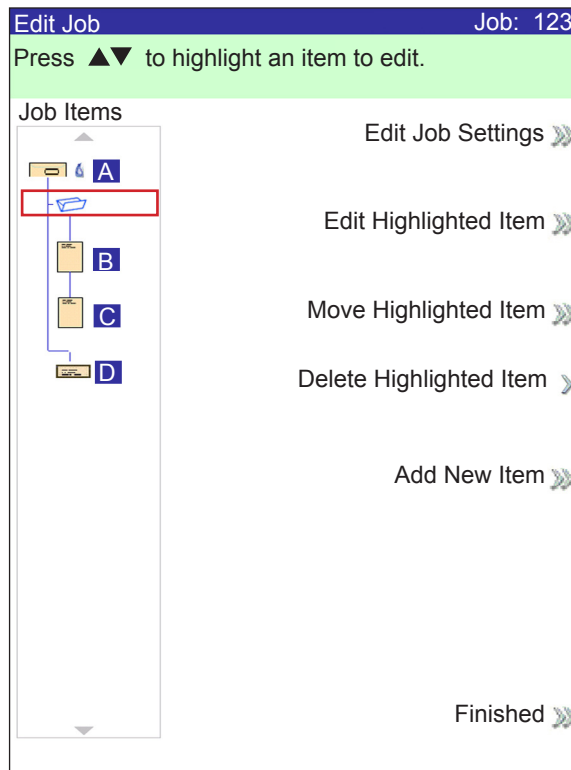

Edit Job Screen

NOTE: The options available in the Edit Job screen vary and depend on the item selected and the number of available Trays on the Feeder Tower.

3 • Basic Operation

Modifying Job Settings

You can make changes to the job settings using the procedure described below.

1. From the Home screen select “Menu”, “Jobs” and then “Edit Current Job”.
2. Select “Edit Job Settings”.
3. The Job Comments screen displays. You can add Job Comments, toggle the Batch Mode on or off, make adjustments to the Batch Count and Set Over Max Count settings, or turn on the Use Postage Meter feature.

NOTE: Refer to the *Job Settings* table in this chapter for more information about these options.

4. Select “Accept” when done editing these options.
5. To retain your changes for this job, select “Finished” in the Edit Job screen. To store the job changes permanently, select “Save Current Job” in the Job screen. You must have supervisor or manager access rights to save a job.

Editing an Item

You can edit items to your mail piece one at a time using the procedure described below.

To edit an item in a mail piece:

1. From the Home screen select “Menu”, “Jobs” and then “Edit Current Job”. The Edit Job screen will display.
2. Use the UP/DOWN Arrow Keys to select the item. A highlight will appear around the selected item.
3. Select “Edit Highlighted Item”.
4. The next screen that displays depends on the item you highlighted (outer envelope, sheet, insert, fold, or booklet) in the Mail Piece Icon Tree. Press the desired Screen Option in each menu to select from the available parameters.

NOTE: Available menu items and associated options/actions for each item in the Mail Piece Icon Tree are listed in the *Job Options* section of this chapter.

4. Select “Accept” when done editing these options.
5. To retain your changes for this job, select “Finished” in the Edit Job screen. To store the job changes permanently, select “Save Current Job” in the Job screen. You must have supervisor or manager access rights to save a job.

Adding an Item

You can add items to your mail piece one at a time using the procedure described below.

To add an item to a mail piece:

1. From the Home screen select "Menu", "Jobs" and then "Edit Current Job". The Edit Job screen will display.
2. Select "Add Item".
3. Select the appropriate option: "Add Outer Envelope", "Add Sheet", "Add Insert" or "Add Large Booklet".

NOTE: Only jobs using the HCEF can have two outer envelopes.

4. *If you selected "Add Sheet", "Add Insert" or "Add Large Booklet" the Add Item Location screen displays.*

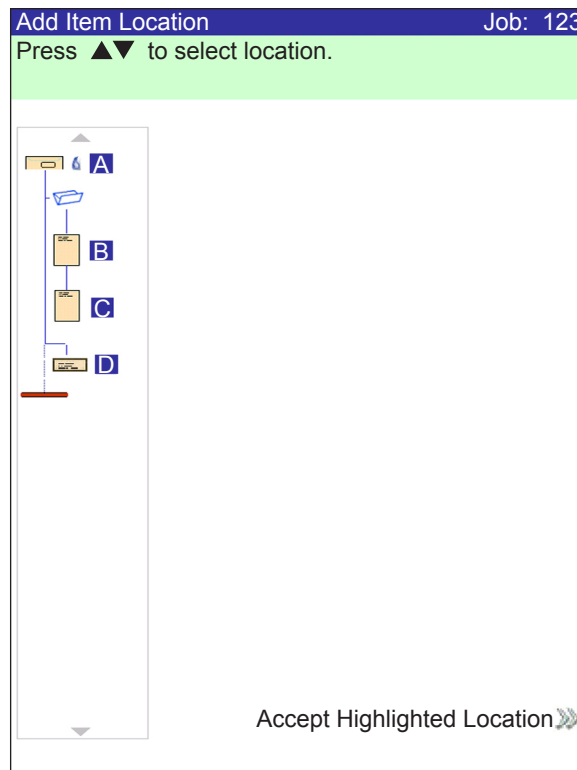

Add Item Location Screen

- a. Use the UP/DOWN Arrow Keys to indicate where in the Mail Piece Icon Tree (the mail piece collation) to place the new item. An Insert Marker highlights the selected area.
- b. Press "Accept Highlighted Location" when you are done.
- c. Depending upon the item you selected, the "Add Sheet", "Add Insert", or "Add Booklet" screen appears. Use the Screen Option keys to define the parameters for the new item.
- d. Select the desired item characteristics.
- e. Press "Accept" when you are done.

3 • Basic Operation

Adding an Item (continued)

5. If you selected "Add Outer Envelope" the Add Envelope screen displays.
 - a. Use the Screen Option Keys to define the new envelope parameters.
 - b. Select the desired item characteristics.
 - c. Press "Accept" when you are done.
6. If you want to add more items, repeat steps 1 through 5, as necessary, for each new item.

NOTE: If you decide that you don't want the changes that you've made, press CANCEL. The Confirm Cancel prompt displays. Press "Don't Keep Changes" to discard the new entries. You will be returned to the Edit Job screen.

7. To retain your changes for this job, select "Accept" in the Edit Job screen. To store the job changes permanently, select "Save Job" in the Menu screen. You must have supervisor or manager access rights to save a job.

NOTE: Recheck the Mail Piece Icon Tree. Moving an item can cause the Feeder assignment to change. If it does, be sure to load the designated item into the correct Feeder.

Moving an Item

To relocate a item within a mail piece collation order:

1. From the Home screen select "Menu", "Jobs" and then "Edit Current Job". The Edit Job screen will display.
2. Use the UP/DOWN Arrow Keys to select the item. A highlight will appear around the selected item.
3. Select "Move Highlighted Item". The Move Item Location screen, shown below, will display.

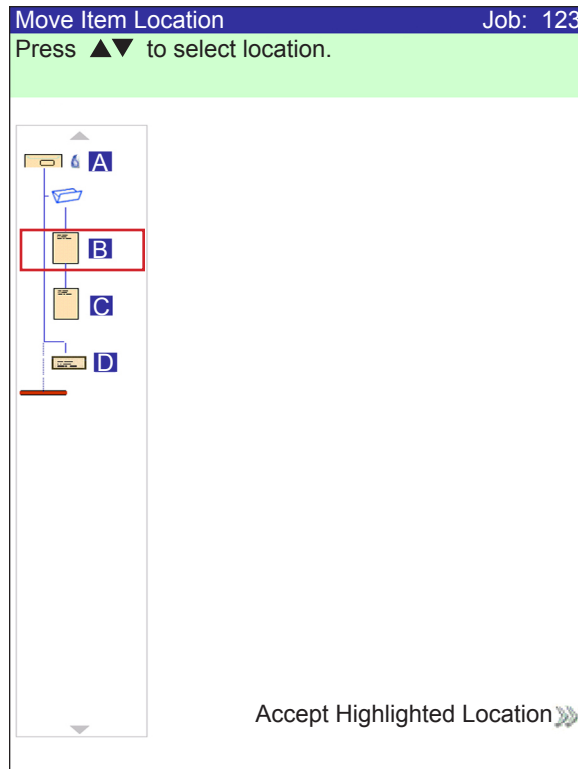

Move Item Location Screen

4. Use the UP/DOWN Arrow Keys to move the red insert marker to the area in the collation where you want to relocate the item.
5. Select "Accept Highlighted Location". You will be returned to the Edit Job screen.

NOTE: Recheck the Mail Piece Icon Tree. Moving an item can cause the Feeder assignment to change. If it does, be sure to load the designated item into the correct Feeder.

3 • Basic Operation

Deleting an Item

To delete an item from the mail piece collation:

1. From the Home screen select "Menu", "Jobs" and then "Edit Current Job". The Edit Job screen will display.
2. Use the UP/DOWN arrows to select the item to be deleted. A highlight will appear around the selected item.
3. Select "Delete Highlighted Item".
4. Select "Yes, Delete Item". You will be returned to the Edit Job screen.

NOTE: Recheck the Mail Piece Icon Tree. Deleting an item can cause the Feeder assignment to change. If it does, be sure to load the designated item into the correct Feeder.

4 • *Advanced Operation*

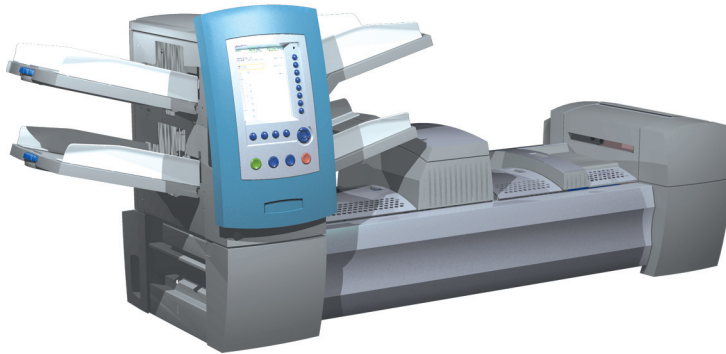

Overview.....	4-2
Using the Alphanumeric Matrix.....	4-2
Saving a Job	4-3
Deleting a Job.....	4-4
Assigning User IDs and Passwords	4-5
Enabling and Disabling the High Capacity Sheet Feeder (HCSF)	4-5

4 • Advanced Operation

Overview

This chapter explains use of the alphanumeric matrix and system use that exceeds the System Operator level of access. Functions explained in the chapter are:

- Using the Alphanumeric Matrix
- Saving a Job
- Deleting a Job
- Assigning User IDs and Passwords (*Manager Level Only*)
- Enabling and Disabling the High Capacity Sheet Feeders (HCSF)

NOTE: Entry of a access code or password from a Supervisor and/or Manager is required for use of these functions. Refer to *Access Rights* in *Chapter 2* in this guide for more information about logging in using the two security modes.

Using the Alphanumeric Matrix

The alphanumeric matrix allows you enter text for naming items and job, for entering job comments, and for logging in and out of the system.

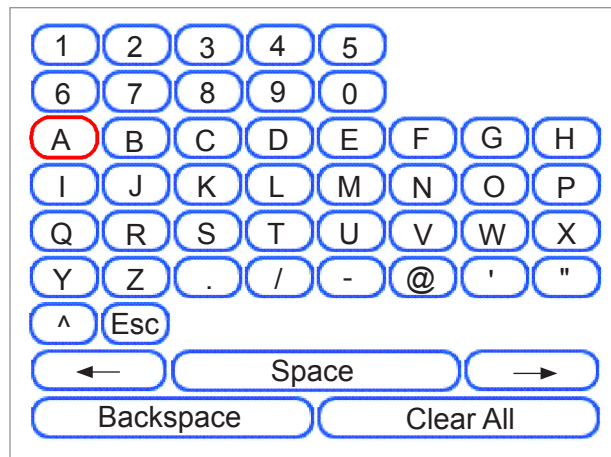

Alphanumeric Matrix

1. Use the UP/DOWN and LEFT/RIGHT Screen Navigation Arrow keys to select any of the following:
 - Desired character.
 - Add a (blank) space in the Job Name and/or Job Comments.
 - Backspace to delete the character that appears immediately to the left of the highlight.
 - Left or Right arrow keys *within the matrix* to navigate within the text.
2. Press OK to display the selected character in the highlighted area of the screen, move left or right, or to delete the character immediately to the left of the highlight.

Saving a Job

Saving a job requires supervisor or manager access rights.

To save a new job:

1. Select "Yes, Save" from the "Create – Save Created Job" screen. Refer to *Creating a Job* in *Chapter 3* of this guide for more information.

NOTE: If you are not logged in with supervisor or manager access rights, you will be prompted to enter an access code.

2. The "Save Job" screen displays. Use the alphanumeric matrix to enter the name of the job. Job names can contain up to 15 characters.
3. Select "Finished" when done.

To save edits and updates made to an existing job:

1. Select "Save Current Job" from the Job Screen. Refer to *Editing a Job* in *Chapter 3* of this guide for more information.

NOTE: If you are not logged in with supervisor or manager access rights, you will be prompted to enter an access code.

2. The "Save Job" screen displays. Select "Finished" to save updates, and edits made to the current job.

To save current job as a different job (new or replace existing job):

1. Select "Save Current Job" from the Job Screen. Refer to *Editing a Job* in *Chapter 3* of this guide for more information.

NOTE: If you are not logged in with supervisor or manager access rights, you will be prompted to enter an access code.

2. The "Save Job" screen displays. Use the alphanumeric matrix to edit the name of the job. Job names can contain up to 15 characters.
3. Select "Finished" when done.

4 • Advanced Operation

Deleting a Job

Jobs that display in the Saved Jobs list are the *only* jobs that can be deleted.

NOTE: Library jobs are permanent residents of the system's memory. The "Delete" function is disabled for the any of the Library jobs.

To delete a job from the Saved Jobs list:

1. From the Home Screen for any job, select "Menu."
2. Select "Jobs."
3. Select "Delete Saved Job." The list of saved jobs displays.

NOTE: If you are not logged in with supervisor or manager access rights, you will be prompted to enter an access code.

4. Select the name of the job you want to delete.
5. Select "Delete job" to confirm the delete command.

NOTE: Selecting "Delete" causes permanent deletion of this job from the system's memory. However, if this is the *current job* the job name will appear on the Home screen, as it is still in the system's "working" memory. Additionally, a copy of the deleted job can be run if it appears in the Recently Run Jobs list.

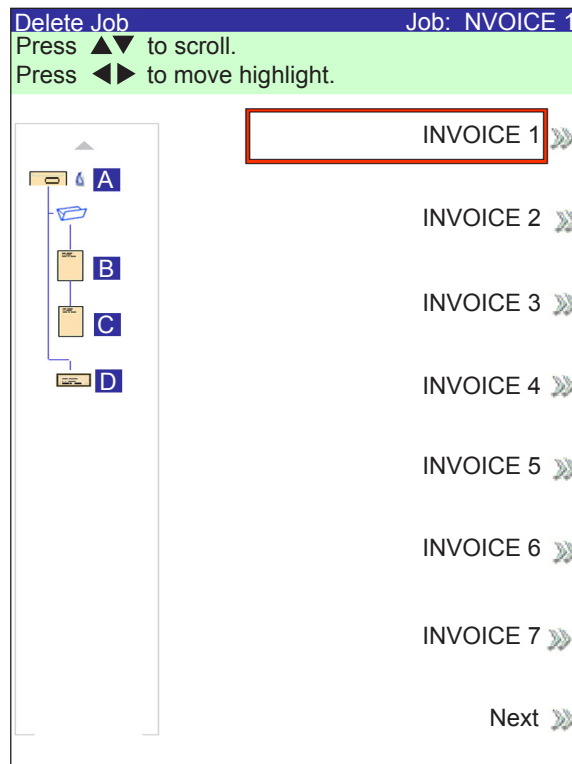

Delete Job Screen

Assigning User IDs and Passwords

You must have Manager level access rights to assign a user ID and password.

1. From the Home screen, select "Menu" and then "Tools."
2. Select "Configure System" and then "Security Level."

NOTE: If you are not logged in with supervisor or manager access rights, you will be prompted to enter an access code.

3. The Security screen displays. Select "User ID Setup."
4. Select "Add New User."
5. The Enter User Name screen displays:
 - a. Use the alphanumeric matrix to enter the user ID.
 - b. Select "Finished" when done.
6. The Select User Level screen displays:
 - a. Use the UP/DOWN arrow keys to select the appropriate access level (operator, supervisor, or manager.)

NOTE: Refer to *Access Rights* in *Chapter 2* of this guide for more information.

- b. Select "Accept User Level" when done.
7. The Enter Password screen displays:
 - a. Enter the password.

NOTE: Passwords are four-digit numeric codes. Numbers 1, 2, 3, 4 and 5 display on the first screen. Press "Next" to access numbers 6, 7, 8, 9, and 0.

- b. Select "Finished" when done.

Enabling and Disabling the High Capacity Sheet Feeder (HCSF)

Follow the steps below to enable or disable the HCSF.

1. On the control panel, enable the Upper and/or Lower Feeder Trays.
2. From the Home screen, select "Menu", "Tools", then "Configure System", and finally "Tools".
3. Select "Enable" or "Disable" for the Feeders that you want.
4. Select "Accept", and then press HOME.

This page is intentionally blank.

5 • Troubleshooting and Maintenance

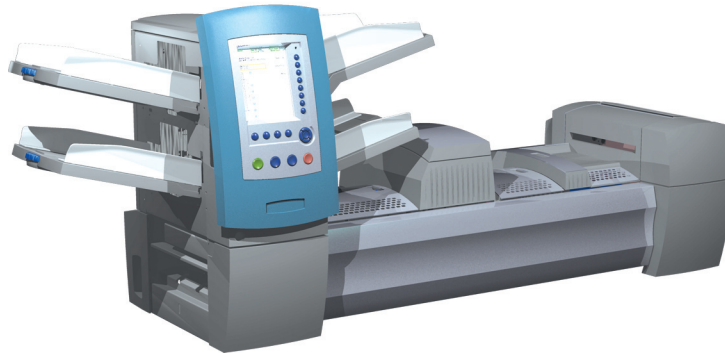

Adjusting Screen Brightness and Contrast.....	5-2
Setting the Time and/or Date.....	5-3
Changing the Language	5-4
Refilling the Sealing Solution.....	5-5
Handling Material Stoppages	5-5
Clearing a Stoppage.....	5-5
Resuming the Job.....	5-6
Handling Outsorted Material.....	5-6
Troubleshooting Tables.....	5-7
Routine Maintenance.....	5-16
Daily Tasks	5-16
Replacing the Moistener Wick	5-16
Replacing the Moistener Brushes.....	5-18

5 • Troubleshooting

Adjusting Screen Brightness and Contrast

Follow the steps below to adjust the contrast and/or brightness of the display screen:

1. From the Home screen, select "Menu".
2. From the Menu screen, select "Tools".
3. From the Tools screen, select "Configure System".
4. From the Configure System screen, select "Set Brightness/Contrast".
5. From the Set Brightness/Contrast screen:
 - Press the UP/DOWN arrow key(s) to increase/decrease screen brightness.
 - Press the LEFT/RIGHT arrow key(s) to decrease/increase screen contrast.
 - To return to the default settings, select "Restore Defaults".
6. When you are done:
 - Press "Finished" to back through the configure system screens and return to the Home screen. Your settings will be saved.OR
 - Press HOME to save your adjustments and return directly to the Home screen.

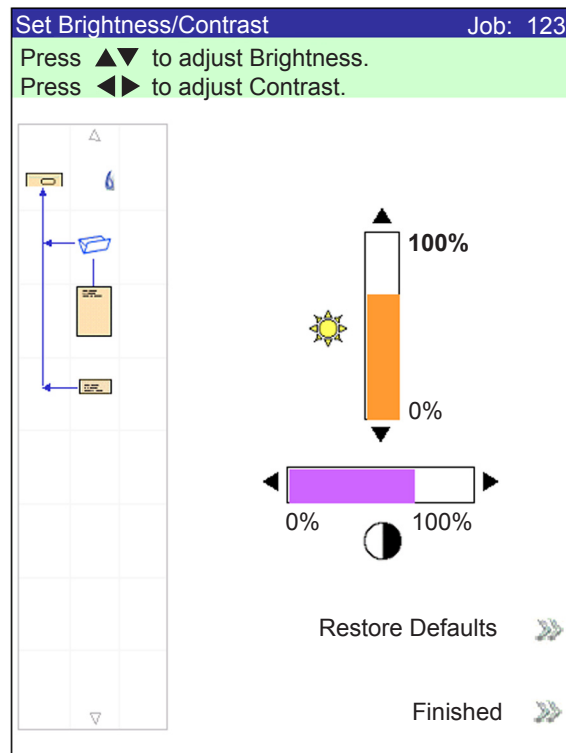

Set Brightness/Contrast Screen

Setting the Time and/or Date

Follow the steps below to adjust the internal Time and/or Date of the system:

1. From the Home screen, select "Menu".
2. From the Menu screen, select "Tools".
3. From the Tools screen, select "Configure System".
4. From the Configure System screen, select "Set Date/Time".

NOTE: If you are not logged in with supervisor or manager access rights, you will be prompted to enter an access code.

5. Press the LEFT/RIGHT arrow key(s) to select the item you want to change, i.e., Month, Day, Year, Hour, or Minute. The items highlight as you press the LEFT/RIGHT arrow key(s).
6. Press the UP/DOWN arrow key(s) to select the desired number.
7. When you are done:
 - Press "Finished" to back through the configure system screens to the Home screen. Your settings will be saved.

OR

 - Press HOME to save your adjustments and return directly to the Home screen.

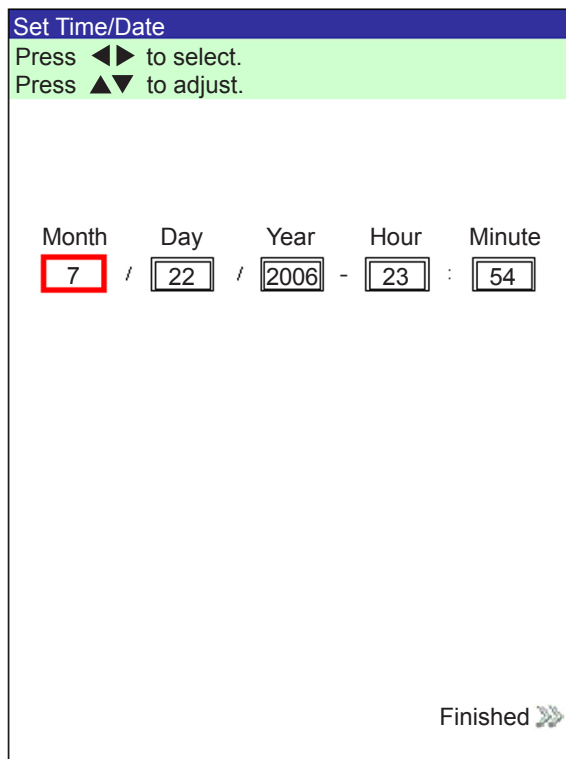

Set Time/Date Screen

5 • Troubleshooting

Changing the Language

Follow the steps below to change the language used on the display screen:

1. From the Home screen, select "Menu".
2. From the Menu screen, select "Change Language".
3. The Change Language screen displays the list of available languages. If necessary, use the "Next" and "Previous" options to view additional languages on the list, then select the appropriate language.
4. Select "Finished" when done.
5. Press HOME to return directly to the Home screen.

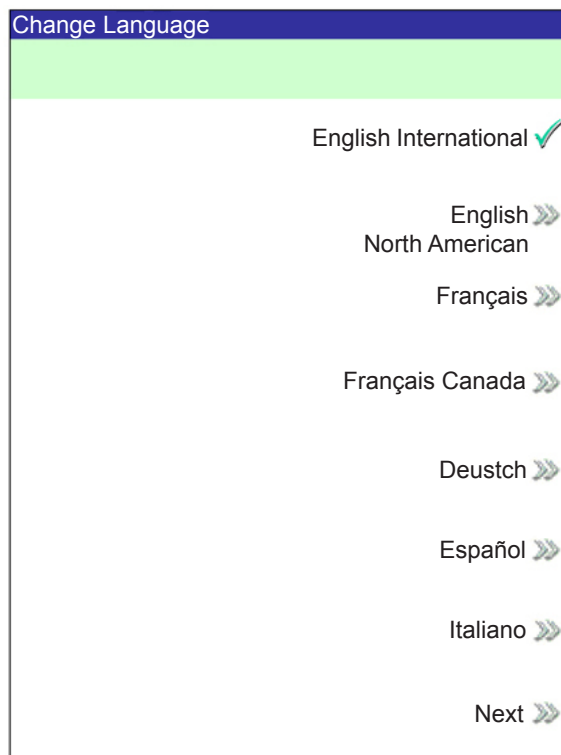

Change Language Screen

Refilling the Sealing Solution

A warning message appears on the Display screen indicating that it is time to replenish sealing solution in the Sealer bottle :

To refill the bottle:

1. Open the Sealer bottle cover and remove the bottle from its holder on the system and place it on a flat surface.
2. Unscrew the pressure-sensitive top and remove it from the bottle.
3. Pour sealing solution into the bottle until it reaches the fill line.

NOTE: Water is an acceptable liquid to use in the Sealer, but is not recommended. The use of water can result in bacterial growth that can inhibit the performance of the Sealer.

5. Screw the pressure-sensitive top securely back onto the bottle.
6. Wipe off any excess fluid that may have spilled.
7. Put the bottle back into the holder and close the Sealer cover.

NOTE: First time use of the sealing system, as well as situations in which the wick has become dry, will require a brief waiting period to allow the wick to get moist.

Handling Material Stoppages

If a stoppage occurs, the system immediately stops the run and displays an error message. Follow the instructions on the Display screen to get your system running again.

The procedure(s) involved with removing material that has caused the stoppage, resuming the run, and handling the outsorts are explained next.

Clearing a Stoppage

The procedure for clearing a stoppage varies and depends on the area in which the stoppage occurs. In general, the steps to clear a stoppage consist of the following:

1. Use the error message information on the Display screen to locate the problem area.
2. If needed, open any covers that allow access to the stoppage. Clear only the area indicated. If prompted to clear deck, press CLEAR DECK.
Refer to *Chapter 2* if you need help on cover removal and/or use of the Paper Release Knobs for accessing and removing stoppage.
3. Follow the instructions on the Display screen to clear the stoppage.
4. Once the stoppage is cleared, close any open cover(s). The error message will clear and the Home screen will display.

5 • Troubleshooting

Resuming the Job

To resume running your job after a stoppage is cleared:

1. Make sure that there are no error messages on the screen and that all system covers are closed.
2. Press START.
 - If the error message on the screen instructed you to remove material in trays to start a new collation, pressing START will begin a new collation, *otherwise*
 - The job will resume counting from the last complete mail piece that it produced.

Handling Outsorted Material

During the recovery from jams and other machine stoppages, the system will automatically clear material from the transport deck that cannot be completed by the inserter.

The system counts all mail pieces that it has successfully completed (trial pieces included), but partially assembled pieces are not counted and are transported to the upper divert area. The user has two options The system handles outsorts in these ways:

- Discard the items.
- Manually assemble the piece.

Troubleshooting Tables

The system will generate an error message when a problem occurs. The message identifies the error and possibly the cause of it. Advice on fixing the problem will also display. In addition to these messages, use the:

- Tables that appear in this manual to identify problems and corrective action(s).
- Help file, that is accessible through the Control Panel by pressing HELP, to view information on system functions and procedures.

If you cannot resolve your problem using these self-help aides, call your system supplier.

Table 5-1 Startup Problems

Problem	Cause	Action
System won't power up.	System power cord is not plugged into the wall outlet.	Plug power cord into wall outlet.
	No power at outlet.	Check outlet. Verify that wall outlet has power.
	Faulty Power Supply, circuit board wiring, or Power Switch.	Call your system supplier.

Table 5-2 Control Panel Problems

Problem	Cause	Action
<ul style="list-style-type: none"> • No display; but system power is on. (LED in upper right corner of the Control Panel is orange or green.) • Display locks up. • Screen Option Keys don't work. • Machine Keys don't work. 	Faulty circuit boards or power supply, loose wiring, or poor connections.	Press the power button to restart system. If problems persist, call your system supplier.
	Display timeout.	Press the OK key turn on the display.
Display is too light or dark (contrast and/or readability problem).	Poor contrast/brightness adjustment.	Adjust contrast and/or brightness settings. See <i>Adjusting Screen Brightness and Contrast</i> in this chapter.

5 • Troubleshooting

Table 5-3 Tower Feeder Problems

Problem	Cause	Action
Failure to feed.	Material not within specifications.	<p>Check that all material meets published specifications. Refer to <i>Feeder Tower Material Specifications</i> in <i>Chapter 6</i> of this guide for more information.</p> <ul style="list-style-type: none"> Remove curled or warped material. Use only material that has been stored properly. <p>NOTE: High humidity can make paper limp and cause curling. Additionally, recycled material can sometimes be problematic.</p>
	Improper loading.	<ul style="list-style-type: none"> Be sure to fan (aerate) material before loading. Be sure to follow the loading instructions as suggested on the display screen. Check side guides. <p>NOTE: Guides set tightly up against stack can disrupt or prevent material from feeding.</p> <ul style="list-style-type: none"> Check that material is loaded in the correct feeder and in the proper orientation.
	Paper fragments or debris in tray, rollers or tower transport.	<p>Inspect feed rollers and transport path. Remove paper fragments before running a clear deck.</p>
Double or multiple feeds; stream feeding.	Material not within specifications.	<p>Check that all material meets published specifications. Refer to <i>Feeder Tower Material Specifications</i> in <i>Chapter 6</i> of this guide for more information.</p> <p>NOTE: Some glossy materials contain contaminants that can clog feed rollers and cause stream or double feeds.</p>
	Improper loading.	<p>Be sure to fan (aerate) material before loading, especially material that has been printed recently.</p> <p>NOTE: Low humidity can cause paper to accumulate a static charge and cling together.</p>
	Dirty, worn or glazed feed and/or retard rollers.	<p>Clean or replace affected rollers. Contact your system supplier.</p>

Table 5-3 Tower Feeder Problems (continued)

Problem	Cause	Action
System incorrectly detects double feeds.	Double detect is seeing flap or seam of insert envelope	<ul style="list-style-type: none"> • Set the custom double detect window where there is no flap, seam or window on the envelope. <p>OR</p> <ul style="list-style-type: none"> • Turn double detect off. <p>Refer to <i>Insert Options</i> in <i>Chapter 3</i> of this guide for more information.</p>
	Sheets or inserts have: <ul style="list-style-type: none"> • Thick printed black text, • Images, or • Thick print on both sides. 	Set the custom double detect window in an area that does not have thick printing, then run the trial piece again. Refer to <i>Sheet Options</i> or <i>Insert Options</i> , and <i>Running a Trial Piece</i> in <i>Chapter 3</i> for more information. If the problem persists, turn double detect off.
	Tray is feeding a mix of different thickness sheets paper (e.g. some 20 lb. and 24 lb. sheets mixed.)	<ul style="list-style-type: none"> • If the material is consistently a certain weight (i.e. printer was initially loaded with 20 lb. paper then accidentally loaded with 24 lb.) then rerun the trial piece. <p>Refer to <i>Running a Trial Piece</i> in <i>Chapter 3</i> for more information.</p> <p>OR</p> <ul style="list-style-type: none"> • Turn off double detect. <p>Refer to <i>Sheet Options</i> in <i>Chapter 3</i> for more information.</p>
First piece following trial piece is a false double.	The initial trial piece was likely a real double.	Run the trial piece again. Refer to <i>Running a Trial Piece</i> in <i>Chapter 3</i> for more information.

5 • Troubleshooting

Table 5-4 Tower Area Problems

Problem	Cause	Action
Stoppage in tower area.	Material not within specifications, causing skew.	<p>Check that all material meets published specifications. Refer to <i>Feeder Tower Material Specifications</i> in <i>Chapter 6</i> of this guide for instructions.</p> <ul style="list-style-type: none"> Remove curled or warped material. Use only material that has been stored properly. <p>NOTE: High humidity can make paper limp and cause curling. Additionally, recycled material can sometimes be problematic.</p>
	Improper loading: material skew caused by Tower feeders.	Check Side Guide adjustment on Trays. Skewed material is a common cause of problems in the Tower area. Refer to <i>Adjusting Tray Side Guides</i> in <i>Chapter 3</i> of this guide for instructions.
	Paper fragments or other obstruction in transport.	Inspect. Clean.
	Flexible plastic material guides in Tower area are broken or displaced.	<p>Open Tower cover and inspect. If replacement is necessary, call your system supplier.</p> 

Table 5-5 Folder/Inverter Problems

Problem	Cause	Action
Stoppage in folder.	Paper fragments.	<ul style="list-style-type: none"> Open Folder and check for obstruction. Remove paper fragments/residues.
Stoppage in inverter.	Material not within specifications.	<p>Check that material meets specifications.</p> <p>NOTE: Sets that use the inverter cannot be wider than 225 mm (8.86").</p>

Table 5-6 Insertion Area/Envelope Flapper Area Problems

Problem	Cause	Action
Stoppage in insertion area or flapper area; failure to insert.	Outer envelope is skewed.	Check Side Guides; incorrect adjustment can cause skewing. Refer to <i>Adjusting Tray Side Guides</i> in Chapter 3 of this guide for instructions.
	Envelope openers improperly adjusted.	Perform setup adjustment. Refer to <i>Adjusting the Envelope Openers</i> in Chapter 3 of this guide for instructions.
	Insufficient edge clearance.	Check clearance: envelope width must be <i>at least</i> 13 mm greater than the sum of the width of the widest insert <i>plus</i> the insert pack thickness. NOTE: For the special case of a single piece into a standard business envelope, 9 mm clearance is sufficient.
	Insertion pack or envelopes not centered.	Ensure that Side Guides are set correctly. Too much clearance between Side Guides and material can cause material to become skewed in machine. Refer to <i>Adjusting Tray Side Guides</i> in Chapter 3 of this guide for instructions.
	<ul style="list-style-type: none"> • Contents of insertion pack are catching on side seam inside of envelope. • Contents of insertion pack are thick and difficult to insert into smaller envelopes. 	Adjust the Aligner custom settings: NOTE: If the contents of the insertion pack are thick, and you are having trouble inserting the pack into a small envelope, be sure to set the "Envelope Width" and "Widest Enclosure Width" to the exact dimensions of the insertion pack. <ol style="list-style-type: none"> 1. From the Home screen, select "Menu", then "Jobs". 2. Select "Edit Current Job", "Edit Job Settings", then "Advanced". 3. Select "Aligner", then "On with Custom Settings". The Customer Aligner Settings screen displays. 4. Select "Envelope Width". Use the UP/DOWN arrow keys to increase or decrease the measurement, as necessary. Select "Accept" when done. 5. Select "Widest Enclosure Width". Use the UP/DOWN arrow keys to increase or decrease the measurement, as necessary. Select "Accept" when done. 6. Select "Accept" on the Custom Aligner Settings screen once the necessary adjustments have been made.

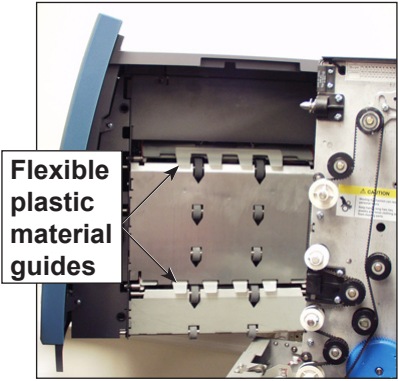
5 • Troubleshooting

Table 5-7 Moistener/Mail Piece Exit Problems		
Problem	Cause	Action
No seal, failure to seal, incomplete seals.	Sealing is off in job set up.	<ul style="list-style-type: none"> Check job definition. Make sure sealer is ON.
	Low sealant level.	Add water or sealing solution.
	Poor quality envelopes.	Inspect envelopes. Examine glue lines.
	Worn moistener brushes.	Inspect. Replace if necessary. Refer to <i>Replacing the Moistener Brushes</i> for instructions.
	Worn moistener wick.	Inspect. Replace if necessary. Refer to <i>Replacing the Moistener Wick</i> for instructions.
High seal: flap is folded and sealed above crease line.	Outer envelope or content skew.	<ul style="list-style-type: none"> Check Side Guide adjustment. Check for proper loading of material in Trays.
	<ul style="list-style-type: none"> Contents of insertion pack are catching on side seam inside of envelope. Contents of insertion pack are thick and difficult to insert into smaller envelopes. 	Adjust the Aligner custom settings: NOTE: If the contents of the insertion pack are thick, and you are having trouble inserting the pack into a small envelope, be sure to set the "Envelope Width" and "Widest Enclosure Width" to the exact dimensions of the insertion pack. <ol style="list-style-type: none"> From the Home screen, select "Menu", then "Jobs". Select "Edit Current Job", "Edit Job Settings", then "Advanced". Select "Aligner", then "On with Custom Settings". The Customer Aligner Settings screen displays. Select "Envelope Width". Use the UP/DOWN arrow keys to increase or decrease the measurement, as necessary. Select "Accept" when done. Select "Widest Enclosure Width". Use the UP/DOWN arrow keys to increase or decrease the measurement, as necessary. Select "Accept" when done. Select "Accept" on the Custom Aligner Settings screen once the necessary adjustments have been made.
	Poor quality envelopes.	Check side seam(s) inside of envelope for excessive stickiness. Glue residue inside of the envelope may prevent it from opening fully and easily.
Stoppage in envelope exit area.	Glue contamination or debris in transport.	Inspect and clean transport.
Box seal: material obstructs envelope fold, causing flat area at crease.	Materials are not inserted deep enough into envelope.	Adjust the Envelope Crease Line upstream so materials are inserted deeper into the envelope: <ol style="list-style-type: none"> At the Home screen select: "Menu", then "Tools", then "Configure System", and finally "Set Envelope Crease". Select the appropriate envelope position. Press "Finished" three times to return to the Home screen.

Table 5-8 High Capacity Envelope Feeder Problems

Problem	Cause	Action
Failure to feed. OR Skew of envelopes.	Envelopes not advancing down Tail Prop.	Push or tap the bottom of the stack of envelopes to advance down Tail Prop.
	<ul style="list-style-type: none"> • Separator Gap set too tight. • Side Guides set too loose or too tight. • Incorrect Tail Prop position. 	Check the Separator Gap, Side Guide, and Tail Prop settings. Refer to <i>Loading the HCEF</i> in <i>Chapter 3</i> of this guide for instruction on the various setup adjustments.
	Debris in area below HCEF.	Remove debris.
Double feeds (envelopes fail to separate), stream feeds.	Separator Gap adjustment too wide.	Perform Separator Gap adjustment. See <i>Adjusting the HCEF Separator Gap</i> in <i>Chapter 3</i> of this guide.
	Incorrect Tail Prop position.	Perform Tail Prop adjustment. See <i>Adjusting the HCEF Tail Prop</i> in <i>Chapter 3</i> of this guide.
	Envelopes nested, stuck or glued together.	Remove unsatisfactory envelopes.
System incorrectly detects double feeds.	Double detect is seeing flap or seam of insert envelope	<ul style="list-style-type: none"> • Set the custom double detect window where there is no flap, seam or window on the envelope. <p>OR</p> <ul style="list-style-type: none"> • Turn double detect off. Refer to <i>Insert Options</i> in <i>Chapter 3</i> of this guide for more information.
First piece following trial piece is a false double.	The initial trial piece was likely a real double.	Run the trial piece again. Refer to <i>Running a Trial Piece</i> in <i>Chapter 3</i> for more information.
Envelopes stop in flapper. OR Envelopes stop in the transport beyond the flapper and are not flapped or partially flapped.	Incorrect loading of envelopes.	Ensure envelopes are properly oriented per the loading instructions on the display screen.
	Envelopes stuck or glued together.	Ensure that the flaps of the envelope are not bonded to the body of the envelope. Remove unsatisfactory envelopes.
	Side Guides set too loose or too tight.	Perform Side Guide adjustment. Refer to <i>Adjusting the HCEF Side Guides</i> in <i>Chapter 3</i> of this guide.

5 • Troubleshooting

Table 5-9 Mail Piece Problems

Problem	Cause	Action
Wrong fold type.	Job is set up incorrectly.	Check job definition and make appropriate adjustments to meet job specifications.
Fold panel length incorrect.	Job is set up incorrectly.	Select automeasure, or make manual adjustments to meet job specifications, then rerun Trial Piece.
Address not showing in envelope window.	<ul style="list-style-type: none">• Item loaded incorrectly.• Lead edge is not in the lead position.	<ul style="list-style-type: none">• Reload item. Refer to <i>Loading Trays</i> in <i>Chapter 3</i> of this guide.• Ensure lead edge is in correct position, as indicated in the loading instructions on the display screen.• On Trial Piece Complete screen, press "Adjust Address" and follow the instruction that appear.
	Job is set up incorrectly.	Ensure the item with the address is personalized, and the correct address location is selected. Also, ensure the selected envelope type is "window" and the flap orientation is correct. If necessary, refer to <i>Editing a Job</i> in <i>Chapter 3</i> of this guide.

Table 5-10 Scanning Problems

Problem	Cause	Action
Two or more collations are inserted in a single envelope.	Scanner head position improperly adjusted.	Check position adjustment of scanner head. See instructions in <i>Chapter 8</i> .
OR	Selected scan definition is incorrect for job.	Select correct scan definition.
A single collation is broken in two and inserted into two envelopes.	Scan definition incorrectly set up.	Review scan setup using scan setup options on the Control Panel.
OR	Material loaded in incorrect order.	Load material in correct order.
System stops and declares an error.	Adverse paper motion. This refers to any misalignment of paper that can cause a misread. It includes paper skew, paper slippage and paper offset to one side of the transport.	Make sure material is properly loaded. In particular, check the feeder side guides. Check the transport is free of obstructions.
NOTE: Recommended OMR thickness is 0.012" to 0.49". For general information on scanning, see <i>Chapter 8</i> .	Poor OMR or barcode printing. Problems include insufficient contrast, poor print quality (voids, fuzzy printing) and inadequate clear zones.	Check the mark specifications to make sure OMR or barcodes are fully compliant. Low toner in laser and dot matrix printers can cause problems, as can rough paper. Certain printing methods (such as ion deposition) can also cause printing problems.
	Scanner inoperative.	Contact your system supplier.

5 • Troubleshooting

Routine Maintenance

This section outlines the maintenance tasks you can perform on the system. Be sure to schedule routine service with your system supplier at the appropriate intervals.

Daily Tasks

- Remove any excess paper dust that has accumulated on or around the system modules.
- Use a damp cloth to wipe unwanted soil marks from the covers.
- Report any system malfunctions and/or noticeable wear on system parts to your supervisor.

Replacing the Moistener Wick

NOTE: Wear on the moistener wick and brushes begins to compromise seal quality at 250,000 machine cycles. It is recommended that you replace the wick and brushes at this time. Please contact your system supplier to order supplies. Refer to the *Contact Information List* at the front of this guide for more information.

Replace the moistener wick when it becomes dry. To do this:

1. Open the Insertion Area cover.
2. Place some paper towels on the Sealer deck to the left of the reservoir. The towels will capture any water that may drip from the old wick cartridge.

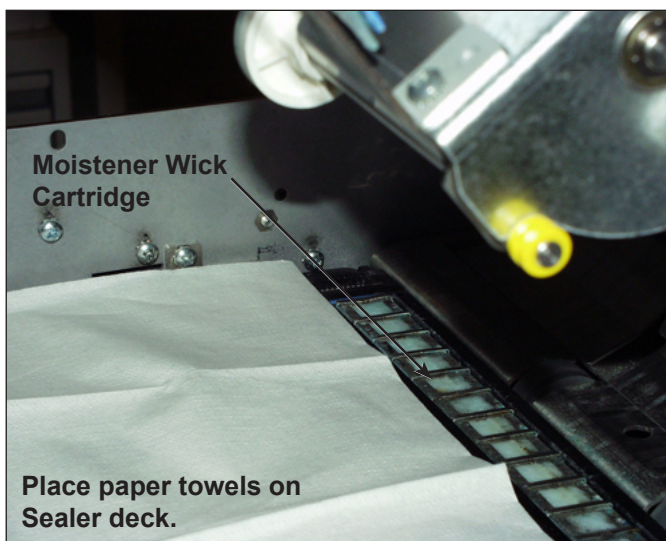

Figure 5.1: Preparing for Wick Cartridge Removal

Replacing the Moistener Wick (continued)

3. Release the plastic latches (one on each side of the reservoir):
 - a. Place the thumb of one hand on the latch at rear of machine (i.e., the latch furthest from you)

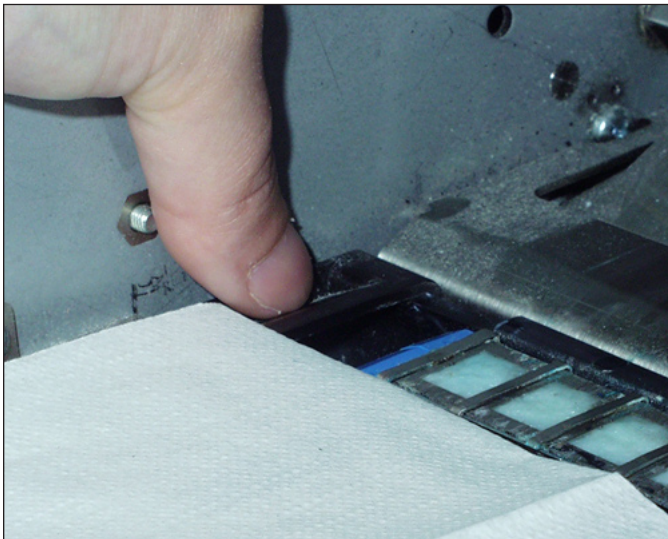

Figure 5.2: Releasing the Rear Latch

- b. Place the index finger of the other hand on other latch (closest to you).
 - c. Slide the latches away from each other until both latches are free of the wick cartridge below them.
4. Pull the old wick cartridge straight up and out of the reservoir, and place it on the paper towels.



Figure 5.3: Removing the Old Wick Cartridge

5 • Troubleshooting

5. Wrap the paper towel around the old wick cartridge and discard.
6. Slide the new wick cartridge into the reservoir. Insert the cartridge with the open side of cartridge facing the exit end (rear) of machine.
7. Press down on the ends of the cartridge to make the two bump features of the cartridge sit below the top edges of the reservoir.
8. Slide the plastic latches toward each other and over the new wick cartridge until they snap into place.
9. Close the Insertion Area cover.

Replacing the Moistener Brushes

Replace the moistener brushes when they show wear. To do this:

1. Open the Insertion Area cover.

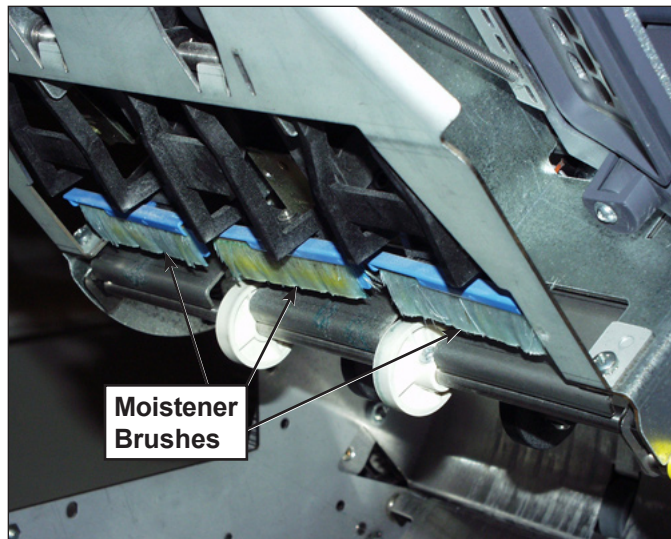
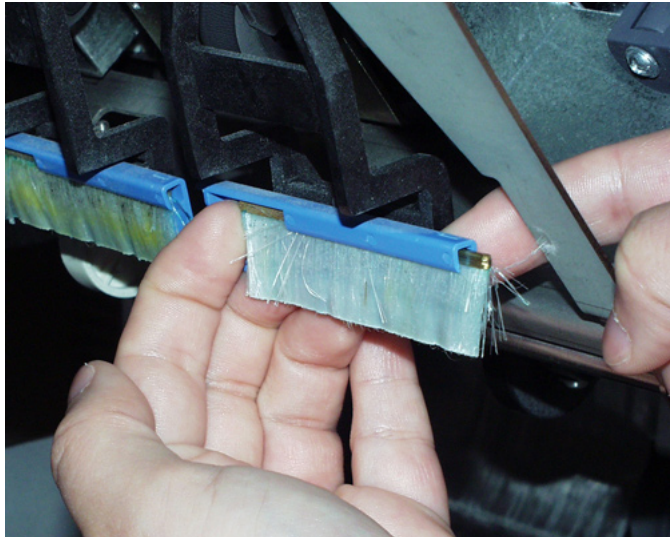

Figure 5.4: Location of Moistener Brushes

Replacing the Moistener Brushes (continued)

2. Remove old brushes:
 - a. Hold the blue brush holder in place with one hand while you use the other hand to push the bristles of the old brush completely free from the holder.

NOTE: You will be pushing the bristles toward yourself .



- b. Repeat for all three brushes and discard.
3. Install the new brushes:

NOTE: Avoid bending or deforming the brush bristles; permanent distortion of the bristles will prevent envelopes from sealing correctly.

- a. Hold the blue brush holder in place with one hand.
 - b. Insert the metal edge of the new brush into the channel opening in front of the brush holder.
 - c. Slightly push the brush into the channel of the brush holder to start it.
 - d. Slide the new brush completely into the holder by its bristles until it stops.

NOTE: The brush is completely inserted when there is no more visible metal edge of the brush extending out from the front of the brush holder..

- e. Repeat for the remaining two brushes.

This page is intentionally blank.

6• Reference



Overview.....	6-2
System Specifications	6-2
Component Specifications.....	6-4
Feeder Tower and Base Material Specifications	6-7
General Information.....	6-7
Outer Envelopes.....	6-7
Inserts.....	6-10
Sheets	6-11
High Capacity Sheet Feeder (HCSF) Material Specifications ...	6-12
General Information.....	6-12
Sheets	6-12
Materials Not Certified for Use	6-13

6 • Reference

Overview

This section lists specifications for DI900/DI950, its hardware components, and the materials that are compatible for use in the system.

System Specifications

Dimensions		
All dimensions are approximate.		
	Length overall, height	Weight, unboxed
DI900C	89" (2261 mm), 31" (787 mm)	327 lbs. (148 kg)
DI950C	89" (2261 mm), 33.5" (851 mm)	350 lbs. (158 kg)
High Capacity Sheet Feeder (HCSF)	43.5" (1105 mm), 28.6" (726 mm)	150 lbs. (68 kg)
Vertical Power Stacker	17" (432 mm), 24" (610 mm)	21 lbs. (18.6 kg)
Exit Transport	20" (508 mm), 16" (406 mm)	52 lbs. (24 kg)
Monochrome Attached Printer*	52" (1320.8 mm), 41" (1041.4 mm)	300 lbs. (660 kg)
Color Attached Printer**	55" (1397 mm), 32" (812.8 mm)	220 lbs. (484 kg)
Flats Sealer	12.5" (317.5 mm), 16" (406.4 mm)	82 lbs. (180.4 kg)

*Does not include HP4350 weight.

**Does not include HP4700 weight.

Electrical		
All systems require a grounded outlet, preferably unswitched. Use of ungrounded outlets, outlets with incorrect polarity or ground adapters can constitute a safety hazard and are unacceptable.		
	Professional	Compact
Line Voltage	88-264 VAC	88-264 VAC
Current Draw	900 V-Amps maximum	450 V-Amps maximum
Frequency	476/63 Hz	47/63 Hz

Environmental Limits					
	Temperature F (C)		Humidity %		Wet Bulb Temp. F (C)
	Minimum	Maximum	Minimum	Maximum	Maximum
Normal Operating Conditions	60 (16)	75 (24)	30	60	N/A
Extended Operating Conditions	50 (10)	95 (35)	08	85	85 (29)
Storage Conditions	15 (-09)	120 (49)	05	95	85 (29)
Shipping Conditions	-40 (-40)	140 (60)	05	100	85 (29)

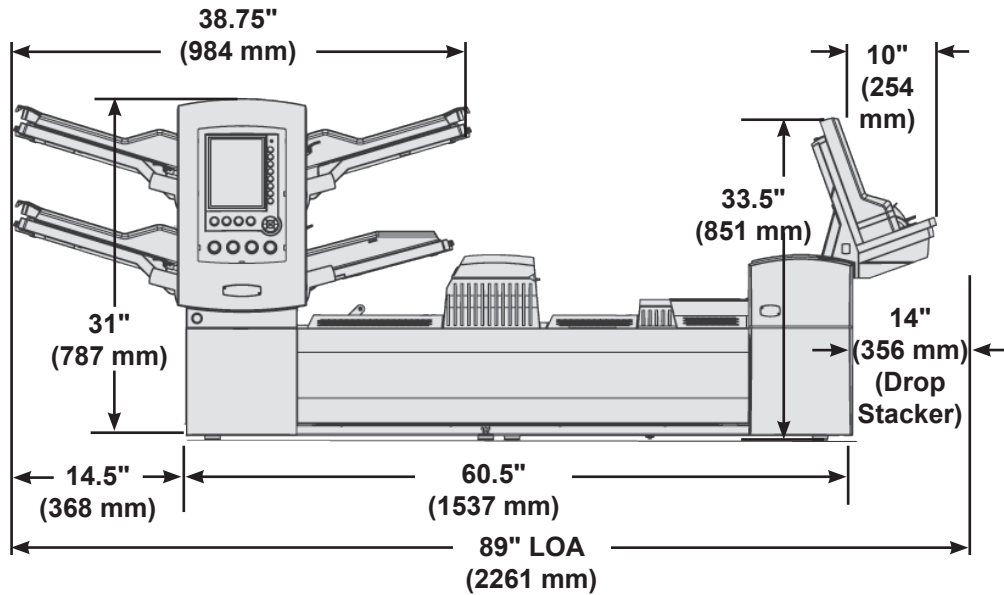

Dimensions for DI900C and DI950C Systems

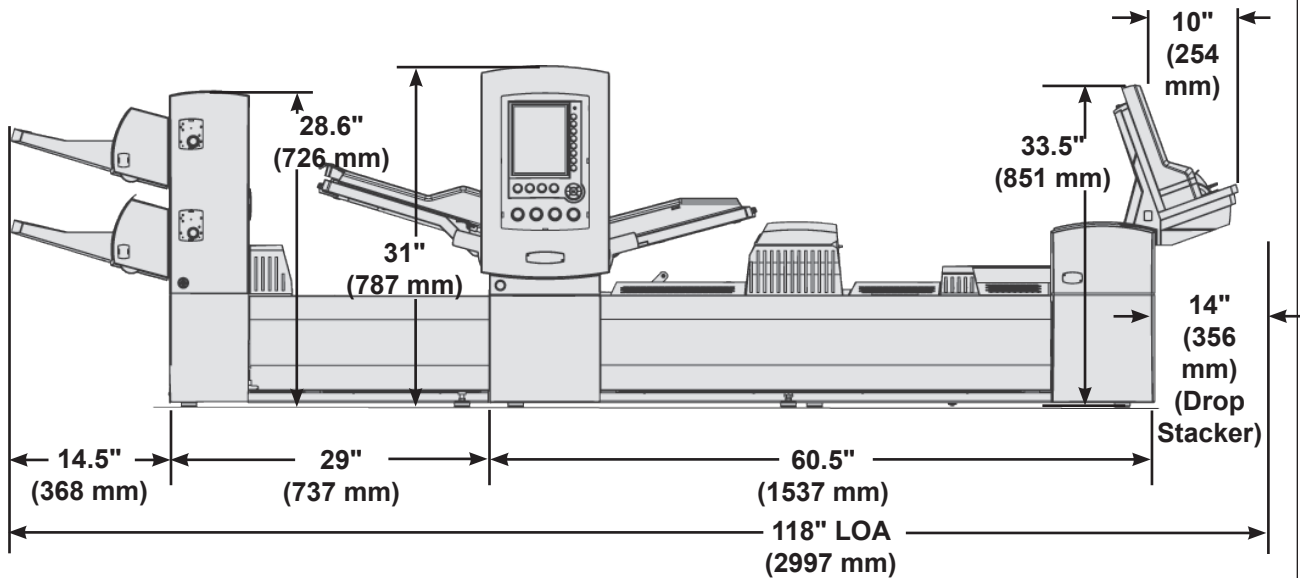

Dimensions for DI900H and DI950H System

NOTE: System depth is 22.8 in (579 mm). Drawings are not to scale. All dimensions approximate. The DI900 does not include the High Capacity Envelope Feeder.

Figure 5.1: Elevation Views

Component Specifications

Capacities	
Tower Sheet/Insert/Envelope Feeders	<ul style="list-style-type: none"> • 350 20 lb. (80 gsm) sheets; 350 insert cards; 250 envelopes. • Feeders are multi-purpose: they can handle sheets, cards, slips and envelopes. • Feeders, including envelope feeders, can be linked to increase running time. • Feeders are available in pairs of two (maximum four feeders).
Folder	Up to 8 sheets of 20 lb. (80 gsm) material.
Accumulator	Maximum collation thickness is 1/4" (6 mm).
High Capacity Sheet Feeder (HCSF)	Available in pairs. Capacity is 2,000 sheets per pair.
Drop Stacker	130 pieces, letter mail; 25 pieces, flat mail.
Vertical Power Stacker	250 pieces, letter mail (assumes single sheet insert).
Production Power Stacker	At least one USPS mail tray (two feet of finished mail).
Moistener/Closer/Sealer	8,000 letters before refilling.

Folder			
Fold Types	Top address documents	C fold, Z fold, single and double fold	Maximum number of sheets per collation: 8 (20 lb. [80 gsm])
	Bottom address documents (see Notes below)	C fold, Z fold and single fold	
	Middle address documents (see Notes below)	C fold	
Machine Adjustments	None		
No-Fold (Bypass)	Yes		
Notes	<ul style="list-style-type: none"> • Documents with addresses on the bottom <i>may</i> require the Inverter kit. • Documents with an address present on the middle of the sheet <i>always</i> require the Inverter kit. • Refer to the <i>Available Fold Type/Address Location/Envelope Type Combinations</i> table in this chapter for more information. 		

Component Specifications (continued)

Available Fold Type/Address Location/Envelope Type Combinations		
Fold Type	Address Location	Envelope Type
C Fold	Top	Standard Flap
	Middle	Forward Flap
	Bottom	Bottom Flap
	Middle*	Standard Flap*
Z Fold	Top	Standard Flap
	Bottom	Bottom Flap
	Bottom*	Standard Flap*
Single Fold	Top	Standard Flap
	Top	Bottom Flap
	Bottom	Bottom Flap
	Bottom	Standard Flap
Double Fold	Top	Standard Flap
	Third Panel*	Standard Flap*

*This Fold Type/Address Location/Envelope Type combination requires an inverter.

High Capacity Envelope Feeder (HCEF)	
The HCEF is standard on the DI950 professional series; it is not available for the DI900 series.	
Material	Letter-size envelopes
Material Dimensions	Depth: 3.5" (89 mm) to 6.5" (165 mm) Width: 8.5" (215.9 mm) to 10.5" (266 mm)
Capacity	500 letter-sized pieces, 24 lb. (90 gsm) weight.

Scanning Capability (Optional)	
The DI900/DI950 base module and the HCSF have an optional scanning capability for reading ladder format OMR and barcode marks. The HCSF has an optional scanning capability for reading picket format barcodes. The scanner kits are field installed.	
OMR Codes Supported	5-Series, 3-Series, SECAP™ 2600, Pitney Bowes® Console.
OMR Functions Supported	Variable page documents; selective feeding; feeder-to-feeder matching; force divert; mark for special handling.
Barcode Formats Supported	Code 39™ (3 of 9); Interleaved 2 of 5.
Notes	The horizontal position of the scanner is operator adjustable. Documents from any feeder can be scanned. Documents should be printed on a laser printer for scanning. Photo copied documents and documents printed on an ink jet printer cannot be scanned.

Component Specifications (continued)

Attached Printer (Optional)	
The Attached Printer is an option for both the DI900 and DI950 Series inserters.	
Material	Letter-size or A4 sheets #10, #11, 6 x 9" (x mm x xx mm), or flat envelopes
Material Dimensions	Depth: 3.86" (98 mm) to 6.5" (165 mm) Width: 8.86" (225 mm) to 10.39" (264 mm)
Capacity	<ul style="list-style-type: none"> • Black and White (Monochrome): 2000 sheets with one 500 sheet tray and one 1500 sheet tray • Color: 1000 sheets with two 500 sheet trays
Printing Options	Simplex (single-sided) and Duplex (double-sided)
Notes	<ul style="list-style-type: none"> • Printed sheets can be C or single folded and inserted or inserted into flat envelopes without folding (no fold). • Sheets cannot utilize top address Z fold with the Attached Printer. • The Attached Printer supports all scanning functions except BOC control. • Scanning marks are not required on documents when running a fixed number of pages per document. • The Attached Printer can be used as a standalone printer for normal printing applications. • The inserter can be used as a standalone inserter for inserting jobs that do not require the Attached Printer.

Feeder Tower and Base Material Specifications

General Information

For reliable operation, all materials must conform to published specifications. Feed problems and high stall rates are often due to use of substandard materials.

Any material fed for letter-size mail pieces shall be capable of being transported through a 1.5 inch (38 mm) radius, 1/4 turn without permanent deformation, breaking of perforations, or any other damage to the piece.

Color Restriction: none for pre-printed materials.

Minimum Paper Opacity: 5% less than 16 lb bond/60 gsm copy paper.

Maximum Paper Opacity (when double detection is required) is 5% greater than 24 lb. bond/90 gsm copy paper with normal 10 point printing throughout the page.

NOTE: Any substance added to improve material handling (such as powder) shall not fall off in visible quantities when the sheet is tapped on the edge of a hard surface.

Outer Envelopes

Envelope Construction and Material

- Envelopes shall be standard side seam, diagonal side seam, center seam, or executive. They can be die or web cut, with or without patched windows.

NOTE: Unpatched (open) window outer envelopes are not permitted.

- Window patches shall be flat, ripple free and made of glassine or polystyrene material. Patches shall be glued within 0.06 inch (1.6 mm) from the top edge of the patch material to the window cutout.
- Envelope materials shall include new or recycled white wove, manila, and lithographic material. Non-woven or synthetic envelopes (e.g., Tyvek®) or envelopes with external fasteners are not permitted.
- Envelopes with remoistenable flap adhesives made of starch (dextrin), resin (tropical formulation) or combination of the two may be used.
- Outer envelope using self-seal, peel and stick, or pressure seal flaps are not permitted.
- The distance between the glue line and the bottom flap edge of the envelope shall not exceed 0.08 inch (2 mm).

Envelope Size for Insertion

- Envelopes shall be at least 0.5 inch (13 mm) wider than the sum of the maximum width of the insert pack plus the thickness of the pack.
- Envelopes shall be at least 1/4 inch (6 mm) deeper than material to be inserted.
- No more than three letter-sized sheets can be inserted into a #9 envelope when the aligner is in use.

6 • Reference

Outer Envelopes Envelope Throat Definitions (continued)

NOTE: Diagram is not drawn to scale.

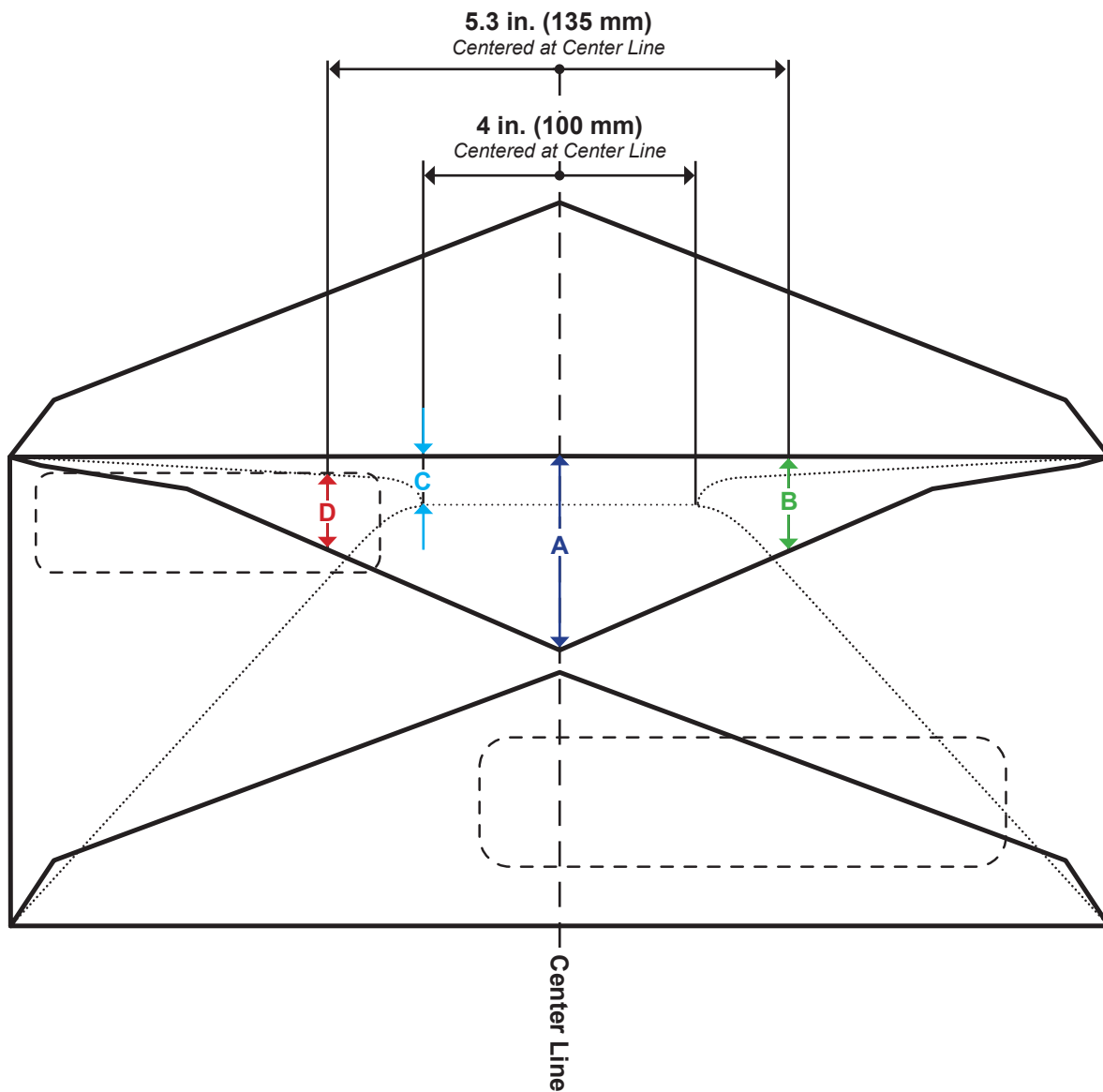

Dimension	Value	Description
A	1.6 inch (41 mm)	Maximum throat depth measured at the center line of executive style envelopes.
B	1.4 inch (38 mm)	Maximum throat depth measured at a distance of 5.3 inches (135 mm) centered at the center line.
C	.25 inch (6 mm)	Minimum throat depth within a 4 inch (100 mm) area centered at the center line.
D	.08 inch (2 mm)	Minimum distance from top of window to the envelope throat measured at a distance of 5.3 inches (135 mm) centered at the center line.

**Outer Envelopes
(continued)**

Envelope Curl/Warp

- An envelope placed flap up on a flat surface under its own weight shall have no corner raised more than 0.5 inch (13 mm) from the surface.
- Curl/Warp of the envelope flap shall not exceed 1/8 inch (3 mm) measured while holding flap on flat surface at the crease line.

Letter-Sized Envelope Specifications		
Parameter	Minimum Value	Maximum Value
Width	Feeder Tower: 6.37" (162 mm) HCEF: 8.9" (225 mm)	Feeder Tower: 10.5" (266 mm) HCEF: 10.4" (264 mm)
Depth	Feeder Tower: 3.5" (89 mm) HCEF: 3.9" (98 mm)	6.5" (165 mm)
Throat Depth*	0.25" (6.35 mm)	1.49" (37.846 mm), executive 1.61" (40.894 mm)
Paper Weight	18 lb. (70 gsm)	24 lb. (90 gsm)
Flap Depth	1.2" (30 mm)	2.5" (63 mm) within +/- 1/4" (35 mm) of Center 1.85" (47 mm) outside +/- 1.4" (35 mm) of Center

*See *Envelope Throat Definitions* in this chapter for more information.

Feeder Tower - Flat-Sized Envelope Specifications		
Parameter	Minimum Value	Maximum Value
Width	6.37" (162 mm)	10.5" (266 mm)
Depth	6.5" (165 mm)	13" (330 mm)
Throat Depth	0.25" (6.35 mm)	1.49" (37.846 mm)
Paper Weight	20 lb. (80 gsm)	24 lb. (90 gsm)
Flap Depth	1.2" (30 mm)	2.5" (63 mm)

Inserts

“Inserts” are defined as material that does not require folding (may be pre-folded) before insertion into letter-sized envelopes. This definition includes individual sheets, collations of unfastened sheets, C folded or single folded inserts or pre-made, bound booklets (no fastener exposed that might damage rollers).

Additionally, "insert" also refers to a single reply envelope (BRE) when inserted into a flat-sized envelope.

Material Substrates

Acceptable paper types include new or recycled bond, text, laser and offset. Offset coatings include matte, dull or gloss.

NOTE: Use of glossy material may degrade system performance.

Grain

Material may be short or long grain.

Printing

Printing may be simplex (one side) or duplex (both sides) with no restriction on color.

Coating

Varnish applied to sheets to modify finish is allowed.

Feeder Tower - Insert Specifications		
Parameter	Minimum Value	Maximum Value
Width	5 inches (127 mm)	9.84 inches (250 mm)
Length	2.83 inches (72 mm)	6 inches (153 mm)
Thickness	0.003 inches (.076 mm)	0.1 inches (2.54 mm)
Paper Weight	16 lb. (60 gsm)	44 lb. (175 gsm)

Sheets

Sheets refer to material that must be folded before being inserted into standard letter envelopes. In the special case of flats, sheets are not folded. A group of sheets is referred to as a collation.

Material Substrates

Acceptable paper types include new or recycled bond, text, laser and offset. Offset coatings including matte, dull or gloss.

NOTE: Use of glossy material may degrade system performance.

Grain

Material may be short or long grain.

Printing

Printing may be simplex or duplex with no restriction on color.

Coating

Varnish applied to sheets to modify finish is allowed.

Laser-Printed Material

Freshly laser-printed material which meets the curl requirements is acceptable.

Feeder Tower - Sheet Specifications		
Parameter	Minimum Value	Maximum Value
Width	5 inches (127 mm)	9.84 inches (250 mm)
Length	5.31 inches (135 mm)	14 inches (356 mm)
Thickness	0.003 inches (0.076 mm)	0.012 inches (0.305 mm)
Paper Weight	16 lb. (60 gsm)	44 lb. (175 gsm)

High Capacity Sheet Feeder (HCSF) Material Specifications

For reliable operation, all materials must conform to published specifications. Feed problems and high stall rates are often due to use of standard materials.

General Information

Any material fed for letter size mail pieces must be capable of being transported through a 38 mm (1.5") radius 1/4 turn without deformation, breaking of perforations, or any other damage to piece.

There is no color restriction on pre-printed materials.

Sheets

Sheets refer to material that must be folded before being inserted into standard letter envelopes. In the special case of flats, sheets may not be folded. A group of sheets is referred to as a collation.

Material Substrates

Acceptable paper types include new or recycled bond, text, laser, offset and single sheet NCR. Offset coatings including matt, dull or gloss.

NOTE: Use of glossy material may degrade system performance.

Grain

Material may be short or long grain.

Printing

Printing may be simplex or duplex with no restriction on color.

Coating

Varnish may be applied to sheets to modify finish.

Laser-Printed Material

Freshly laser-printed material which meets the curl requirements is acceptable.

HCSF - Sheet Specifications		
Parameter	Minimum Value	Maximum Value
Width	7.99 inches (203 mm)	8.5 inches (216 mm)
Length	9.15 inches (232mm)	11.69 inches (297 mm)
Basic Weight	20 lb. (75 gsm)	24 lb. (90 gsm)

NOTES:

- All sheets within a collation shall be within 10 mm (0.37") of each other in length.
- Maximum material thickness for feeders: 0.18 mm (0.007") when scanning, otherwise 0.25 mm (0.009").

Materials Not Certified for Use**Contaminants**

Materials with visible material loss (loose powder, ink, surface glaze, etc.) when hung free over a clean surface and struck sharply with a standard wood ruler should not be used.

Special Materials

- Do not use materials that are sensitive to heat (such as thermal papers).
- Do not use materials that are sensitive to minor magnetic fields.
- Do not use pressure-sensitive materials.

This page is intentionally blank.

7 • Add-On Modules

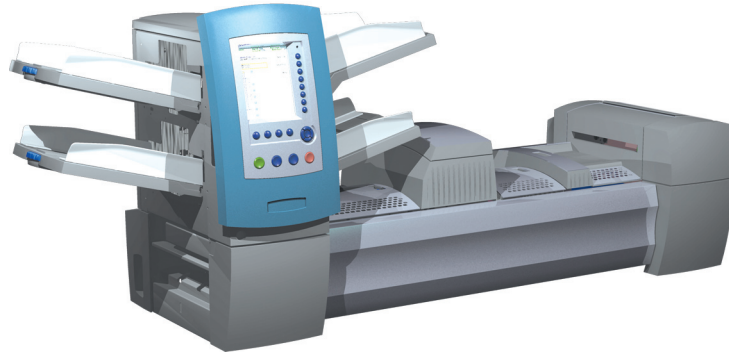

About the Add-On Modules	7-2
High Capacity Sheet Feeder (HCSF)	7-2
Loading the HCSF	7-3
Adjusting the HCSF Guides.....	7-5
Flats Sealer	7-7
Replacing the Envelope Edge Marker Roller.....	7-8
Attached Printer.....	7-9
Loading the Attached Printer	7-10
Adjusting the Printer Interface Guides.....	7-11
Printing a Cover Sheet to the Top of the Attached Printer ...	7-13
SureTrac™ Process Verification System	7-13
Exit Options	7-15
DM Series™ Mailing System Interface (DM800i™ or DM1000™ only)	7-15
OptiFlow™ Vertical Power Stacker	7-18
OptiFlow™ Belt Stacker.....	7-18
Exit Transport	7-18

7 • Add-On Modules

About the Add-On Modules

The system accepts several modules that enable it to maximize performance. Included in this list are:

- High Capacity Sheet Feeder
- Flats Sealer
- Attached Printer
- Pre-folded Insert Feeder
- Power Stacker

High Capacity Sheet Feeder (HCSF)

The HCSF add-on module attaches to the Feed Tower end of the system to provide greater upstream volume. The HCSF has two Feeder Trays and a horizontal transport. Each Feeder Tray holds up to 1000 sheets of 20 lb. (80 gsm) paper.

Sheets move from the Feeders in a pre-determined order and travel down the vertical paper path and into the horizontal transport. Depending on the job setup, individual sheets are either transported directly into the main unit, or they accumulate in the horizontal transport into a pre-determined packet before being transported into the main unit. When Feeder Linking is enabled, you can reload and empty the inactive Feeder Tray (that is, the Tray that is not currently feeding sheets) without interrupting the job run.

The system can handle up to two High Capacity Sheet Feeders. Each HCSF attaches to the next to form an upstream flow from one to the other and finally into the main system.



Figure 7.1: HCSF Attached to System

Loading the HCSF

Each feeder in the HCSF holds up to 1000 sheets of 20 lb. (80 gsm) paper. Refer to *Chapter 6* for recommended specifications on other types and weights of materials.

To load sheets into the HCSF:

1. After loosening the pages of the stack of sheets, turn the HCSF Tray Side Guide Adjustor counterclockwise (↺) to open the Tray wide enough to accommodate the stack of sheets.

NOTE: The Side Guide Adjustor is located below the tray indicator letter.

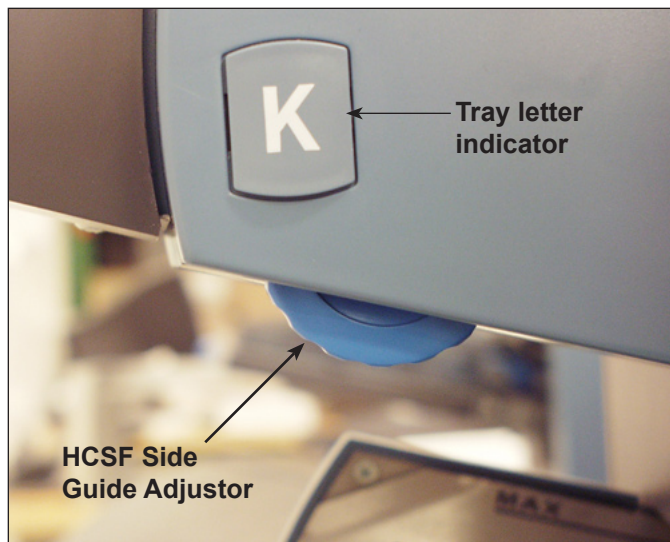

Figure 7.2: HCSF Side Guide Adjustor

2. Load approximately 1 inch of material into the Tray in the orientation specified in the loading instructions on the Home screen. Green lights on the front panel of the HCSF indicate that the material is loaded and that the HCSF is operable.
3. Turn the Feeder Tray's Side Guide Adjustor clockwise (↻) until the side guides touch the material, and then back off slightly.

TIPS:

- For collations of 20 to 25 pieces, back off one full revolution (approximately 2.5 mm) of the Side Guide Adjustor.
 - Turn clockwise to move in, counterclockwise to move out.
-

7 • Add-On Modules

Loading the HCSF (continued)

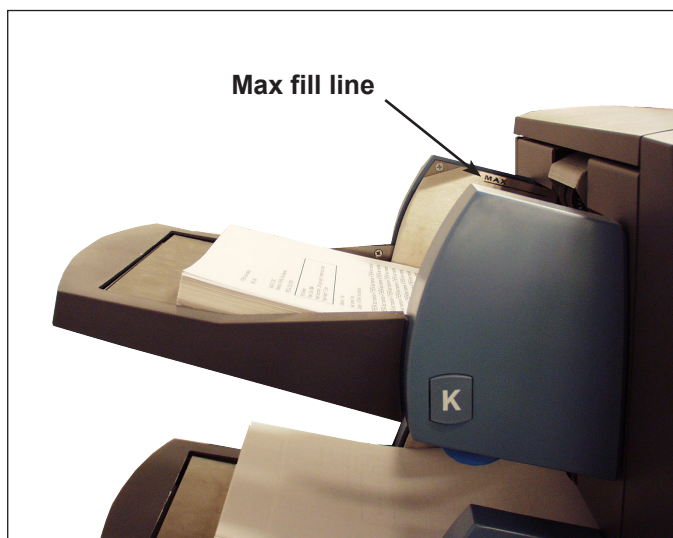

Figure 7.3: HCSF Loaded with Material

4. Load the remaining paper up to the fill line.
5. Repeat steps 2-5 for each remaining HCSF Tray.
6. Press the button on the front of the HCSF for each of the Trays. The loaded Tray(s) will move into position for feeding.



Figure 7.4: HCSF Ready to Feed

Adjusting the HCSF Guides

If the sheet width is different from the sheet width used in the previous job, you need to adjust the HCSF guides for the new job.

IMPORTANT: Make sure you have enabled the High Capacity Sheet Feeder Trays before performing this adjustment. Refer to *Enabling and Disabling the High Capacity Sheet Feeder (HCSF)* in Chapter 4 for more information.

1. From the Home screen, select "Loading Instructions", then "Pre-Run Adjustments", and finally, "HCSF Guide Settings".
2. Select the Feeder that you will be setting up.
3. Press TRIAL PIECE.
4. Open the front and top covers of the enabled HCSF accumulation area.

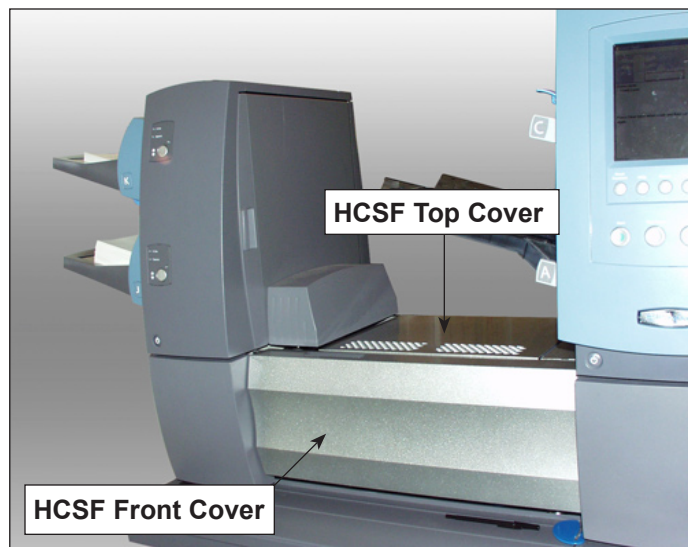

Figure 7.5: HCSF Front and Top Covers

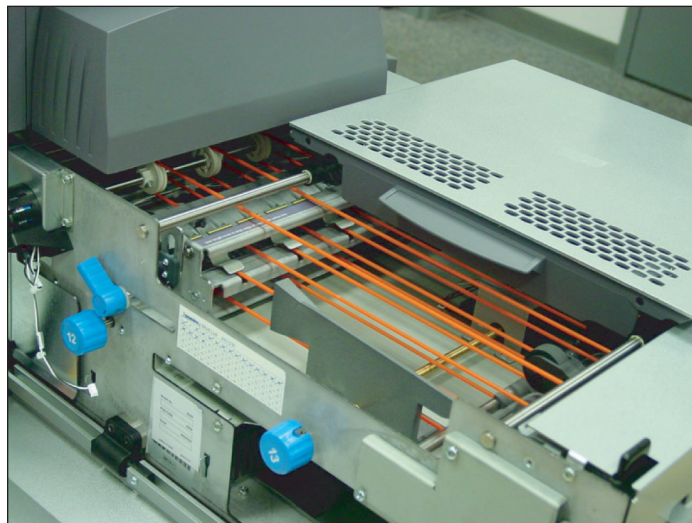

Figure 7.6: HCSF Front and Top Covers Open

7 • Add-On Modules

Adjusting the HCSF Guides (continued)

5. Set the Length Guide:
 - a. Pull the length knob (knob 12) straight out.
 - b. Turn the knob to position yellow line on the Length Guide Bar at the trailing end of the sheet.

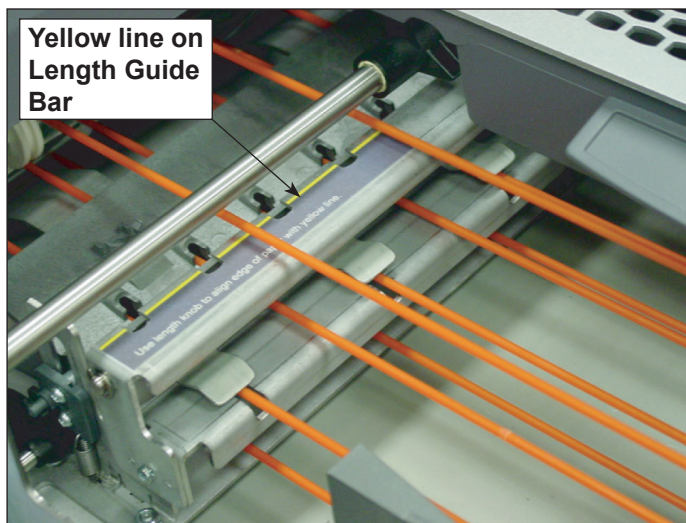

Figure 7.7: Length Guide Bar

- c. Release the length knob once the Length Guide is properly placed.
6. Set the Width Guides:
 - a. Turn the right-hand knob on the side of the sheet transport to move the Width Guides.
 - b. Move the Width Guides until they just make contact with the sides of the sheet, then back off slightly (approximately 1/3 of a turn). The sheet should lay flat, and not buckle.
7. Close the front and top covers of the HCSF accumulation area.
8. Press CLEAR DECK to remove any material in the paper paths.
9. Repeat steps 3 to 8 to adjust the length and width guides until the sheet aligns properly.
10. Repeat the entire procedure for each additional HCSF on your system.

Flats Sealer

The Flats Sealer add-on module attaches to the exit end of the base module to allow for the sealing of flat envelopes. The Flats Sealer can seal flat envelopes up to 0.25" (6.5 mm) in thickness.

In the Moistener, Closer, Sealer module, brushes sweep across the flat envelope flap to wet the glued area of the flap. The Flats Sealer closes the flap, seals the envelope, and sends it on to the next module downstream. While the Flats Sealer is designed specifically to seal flat envelopes, it has an exit path for (sealed) letter envelopes exiting the Moistener, Sealer, Closer module.

Flats Sealer Downstream Attachments	
Letter Exit Path	<ul style="list-style-type: none"> • Drop Stacker (Letter Mail) • OptiFlow™ Vertical Power Stacker • Belt Stacker • Exit Transport/Mail Machine Interface/Mailing Machine
Flats Exit Path	<ul style="list-style-type: none"> • Drop Stacker (Flat Mail) • Belt Stacker • Exit Transport



Figure 7.8: Flats Sealer Module (shown here with an HCEF)

7 • Add-On Modules

The Flats Sealer also contains an envelope edge marker. The envelope edge marker will apply a mark at least 0.5" (12.5 mm) in length along the edge of the envelope facing the operator.

You can use edge mark can be used to indicate tray breaks, ZIP breaks, every 50th envelope, high value checks, etc.

NOTE: The envelope edge mark is applied only to envelopes passing through the letter exit path.

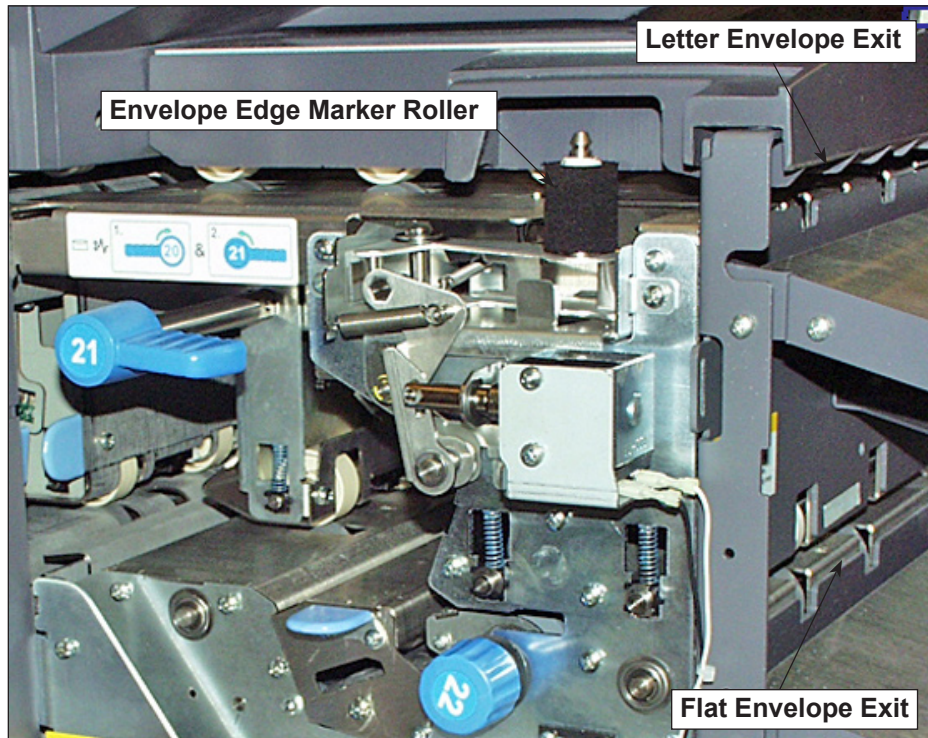

Figure 7.9: Flats Sealer Cover Open

Replacing the Envelope Edge Marker Roller

Follow the steps below to remove and replace the Envelope Edge Marker Roller.

NOTE: Avoid touching the ink roller, as it is covered in ink.

1. Open the Flats Sealer cover.
2. Grasp the tab at the top of the old ink roller and lift to remove.
3. Grasp the tab at the top of the new ink roller and slide it onto the spindle.
4. Release the tab once the ink roller is seated firmly in place.
5. Close the Flats Sealer cover.

Attached Printer

The Attached Printer add-on module attaches to the Feed Tower end of the system to provide one-step printing and inserting, typically into windowed envelopes. The Attached Printer has two sheet trays and a horizontal transport (printer interface accumulator).

There are two printing options available with the Attached Printer: monochrome (prints black and white only) and color. The sheet trays on the monochrome printer hold up to 2000 sheets of 20 lb. (80 gsm) paper. The sheet trays on the color printer hold up to 2000 sheets of 20 lb. (80 gsm) paper with the optional extra trays.

The Attached Printer operates with other system options, including stackers, postage printing, and one High Capacity Sheet Feeder. If present, the Attached Printer must be the most upstream device in the configuration.

IMPORTANT:

- When creating a job, you must indicate that the Attached Printer is the printing source of the job. Refer to *Chapter 3, Sheet Options* for more information.
 - When setting up a Scan Configuration, you *must* set MC to "Is Controlling" to notify the inserter that the control instructions will be based on the MC read on each document. Refer to *Setting Up an OMR Scan Configuration* or *Setting Up a BCR Scan Configuration* in *Chapter 8* for more information.
-

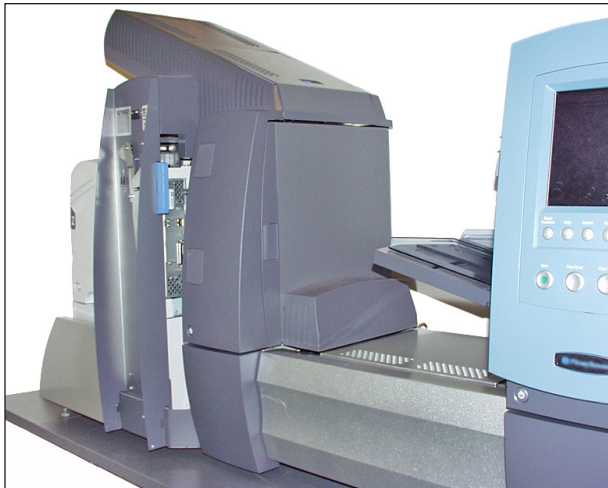

7.10: Monochrome Printer Attached to System











7.11: Color Printer Attached to System

7 • Add-On Modules

Loading the Attached Printer

To load sheets into the Attached Printer:

1. Adjust side guides to accommodate the length and width of the material
2. Load the material no more than the fill line.

Attached Printer Loading Instructions		
Color Printer	Envelope Type	Sheet Orientation
	 Standard Flap	 Face up, top first.
Monochrome Printer	Envelope Type	Sheet Orientation
	 Bottom Flap	 Face up, bottom first.
Monochrome Printer	Envelope Type	Sheet Orientation
	 Standard Flap	 Face down, bottom first.
Monochrome Printer	Envelope Type	Sheet Orientation
	 Bottom Flap	 Face down, top first.

NOTES:

- **Do not** fan sheets when loading the Attached Printer. Fanning sheets can cause static electricity, which can cause sheets to stick together.
- If you are loading letterhead or check stock, find the paper direction for the desired fold type on the label in printer or on the Loading Instructions screen.
- To view a demo of the Attached Printer loading process : go to the Home screen and select "Loading Instructions and Pre-Run Adjustments". Use the UP/DOWN arrow keys to select a Sheet (being fed by the Attached Printer) from the Mail Piece Icon Tree, then select "Feeders Setup Demo".

**Adjusting the
Printer Interface
Guides**

If the sheet width is different from the sheet width used in the previous job, you need to adjust the Printer Interface guides for the new job.

1. From the Home screen, select "Loading Instructions", then "Pre-Run Adjustments", and finally, "Printer Interface Guide Settings".
2. Press TRIAL PIECE.
3. Open the front and top covers of the Printer Interface accumulation area.

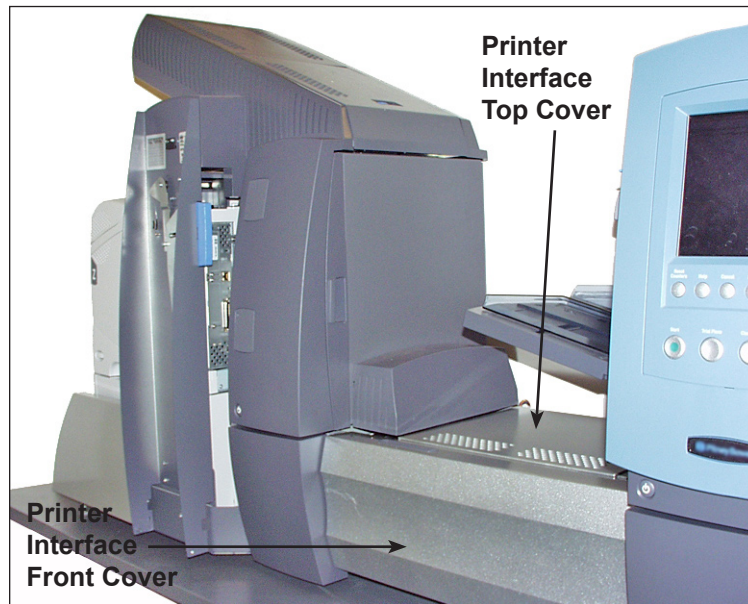

7.12: Printer Interface Covers

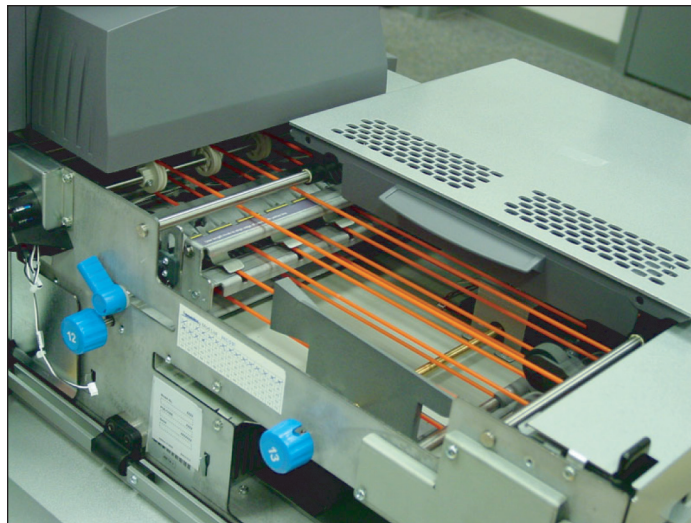

Figure 7.13: Printer Interface Accumulation Area Front and Top Covers Open

7 • Add-On Modules

4. Set the Length Guide:
 - a. Pull the length knob (left-hand knob) straight out.
 - b. Turn the knob to position yellow line on the Length Guide Bar at the trailing end of the sheet.

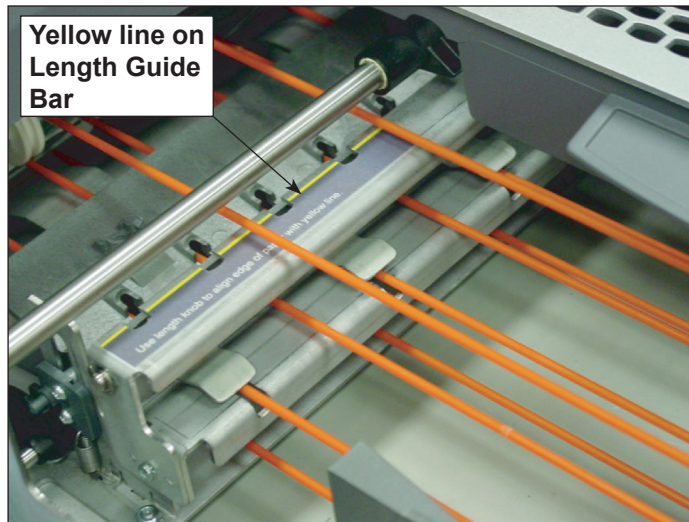

Figure 7.14: Length Guide Bar

- c. Release the length knob once the Length Guide is properly placed.
5. Set the Width Guides:
 - a. Turn the right-hand knob on the side of the sheet transport to move the Width Guides.
 - b. Move the Width Guides until they just make contact with the sides of the sheet, then back off slightly (approximately 1/3 of a turn counter-clockwise). The sheet should lay flat, and not buckle.
7. Close the front and top covers of the Printer Interface accumulation area.
8. Press CLEAR DECK to remove any material in the paper paths.
9. Repeat steps 3 to 8 to adjust the length and width guides until the sheet aligns properly.

Printing a Cover Sheet to the Top of the Attached Printer

The Attached Printer can print a cover sheet containing the scan definition to the top of printer. You can use this information to set up the Scan Configuration on the inserter.

1. From the Home screen, select "Loading Instructions", then "Pre-Run Adjustments", and finally, "Print Cover Sheet to Top of Printer".
2. Remove the cover sheet from the top of the printer.
3. Select "Continue" to return to the Pre-Run Adjustments screen.

Refer to *Setting Up a New Scan Configuration* in *Chapter 8* for information about setting up a Scan Configuration on the inserter.

SureTrac™ Process Verification System

The SureTrac™ Process Verification System consists of a server and a client. The server monitors and records information about the mail pieces processed on the inserter. The client system runs the Mail Creation Print Manager application that you use to create the PDF documents that the inserter turns into finished mail pieces.

You typically use the SureTrac™ Process Verification System to run jobs in either a closed loop mode or an open loop mode.

- In the closed loop mode, the client creates the PDF on the client PC and a Mail Run Data File (MRDF) on the server PC. The server monitors and records information about every mail piece as it is processed on the inserter. As the inserter processes a mail piece, it sends status information to the server PC about the disposition of the mail piece. The tracking and disposition information is stored in the Mail Run Data File (MRDF) on the server PC.
- In the open loop mode, the server is not required. The client can upload scan code information from the inserter if the inserter is connected (via network) to the client PC. This mode is also referred to as online open loop mode. In this mode, you can use the scan codes from the inserter when you create the PDF. If there is no connection between the inserter and the client PC, you use the Mail Creation Print Manager to create the scan codes used in the PDF.

The following is a high level overview of how you use the Mail Creation Print Manager modules to create a PDF document. Depending on whether you are running an open loop job or closed loop job, you either process the job directly at the inserter (open loop job), or use the SureTrac™ Process Verification Server modules (closed loop job) to instruct the inserter to turn that PDF document into finished mail pieces.

- Use the Mail Creation Print Manager to create all of the control codes that the inserter will use to turn the PDF document into finished mail pieces. If you are running an open loop job, all of the necessary controls codes are contained in the scan codes printed on the pages of the document. If you are running a closed loop job, a small scan code is printed on the pages of the PDF to identify each mail piece but all other control code information is contained in a Mail Run Data File (MRDF) that is stored on the SureTrac™ Process Verification Server PC.
- Print the PDF document for your job at the Mail Creation Print Manager PC. For an open loop job, load the document at the inserter and run the job. All setup and processing will be done directly at the inserter. All the remaining steps in this overview apply to a closed loop job.
- For a closed loop job, use the Run Closed Loop Jobs module at the SureTrac™ Process Verification Server PC to select the MRDF file (the MRDF is associated with a job) and up to three inserter machines. After electing the MRDF, the server PC sends a message to the inserter telling it to make this the active job.
- Instructions appear in the display on the inserter that tell you how to load the PDF document and other required materials (for example, where to load the PDF document, envelopes and other inserts if necessary) into the machine. For detailed information on selecting jobs at the inserter machine, refer to the operator guide provided with the inserter.
- Load the printed PDF document and all other required materials into the inserter and start the job. As soon as the inserter begins processing the mail pieces, it sends the status information for each mail piece to the SureTrac™ Process Verification Server PC which updates the MRDF file with this information.
- Use the Reconcile Mail Runs module at the SureTrac™ Process Verification Server PC to check the status of the job and if necessary, correct mail pieces that have been flagged as damaged or incomplete.
- After you have reconciled all mail pieces, use the Reprint module to reprint the damaged mail pieces. You can then take the reprinted pages and load them on the inserter as before.

Refer to the *SureTrac™ Process Verification Software User Guide* for more information about running jobs with this software.

Exit Options

The exit portion of the system accepts a variety of options. The Letter Drop Stacker and the Flats Drop Stacker are standard options for all systems.

DM Series™ Mailing System Interface (DM800i™ or DM1000™ only)

The Mail Machine Interface (MMI) enables communication between the inserter and the DM800i or DM1000 mailing systems via a USB connection.

The inserter sends start and stop signals to the mailing system, and the mailing system can send error messages back to the inserter to stop feeding.

- When the inserter starts the mailing system, it will toggle the Sealer to “Off” and take control of the timeouts.
- The inserter monitors the number of pieces exiting the DM800i or DM1000 in order to prevent the mailing system from being overloaded with mail.

If the mailing system is overcome with mail, the inserter will pause until the mailing system can process the mail and will then resume.

- When the mailing system is in maintenance mode, the inserter will pause until the maintenance is complete.
- If you want to operate the mailing system in standalone mode, press the **Stop** key on the IntelliLink® Control Center. The inserter will finish creating any mail pieces in process. Press **Start** (at the mailing system) to finish processing any pieces of mail on the feeder. Then, refer to your the operating guide for you mailing system for instructions on processing mail.

NOTE: Once you have completed processing mail in standalone mode, press the **Stop** key. To resume using the MMI Interface, start the inserter.

Running the Mail Machine Interface

Follow the steps below to process mail using the MMI.

1. Power-up the inserting system.
2. Power-up the mailing system.
3. Ensure that the inserting system has been set up for the job:
 - The job must be loaded.

NOTE: The job must have "Use Postage Meter" option set to "On" for the MMI to function. Refer to *Creating a Job* in *Chapter 3* for more information.

- The material must be loaded.
- A trial piece must be run successfully.

7 • Add-On Modules

4. Ensure that the mailing system has been set up to process mail:
 - The class must be set.
 - The rate/weight must be set.
 - The mode must be set (if appropriate).

NOTE: Refer to the Operator Guide for your mailing system for more information about processing mail.

5. Adjust the side guide to the width of an envelope that will be used. See figures below for DM800i™ requirements.

NOTE: The MMI does not support flats.



Figure 7.15: DM800i™ Side Guide



Figure 7.16: Clearance Between Envelope and Side Guide

6. Verify the following:
 - that there are sufficient funds for the job on the mailing system;
 - that the MMI is working; and
 - that the correct mode is set on the mailing system.
8. Press the **Start** button on the inserting system.

NOTE: The IntelliLink® Control Center must be at the Main screen for the interface to work. If the Control Center is not at the Main screen (for example, in Sleep Mode), the “Postage Meter Unavailable” message will appear on the inserter display screen.

The inserting system begins to assemble pieces of mail, which the mailing system will then accept and process. The mailing system sends the inserting system a message for each exiting piece of mail.

Clearing a Jam

If a jam occurs on the mailing system while processing mail with the MMI, the “Remove Mailpiece” screen appears on the IntelliLink® Control Center.

Follow the steps below to clear the jam and resume processing mail.

1. Lift the mailing system cover(s) and remove the piece of mail from the inside of the mailing system.
2. Select **Clear to bypass error** on the control center.
3. Press **Start** at the inserting system. Any mail remaining in the feeder is printed, then the inserting system continues assembling and depositing pieces of mail on the feeder.

OptiFlow™ Vertical Power Stacker

The Optiflow™ Vertical Power Stacker is a compact, powered, bottom-feed stacker that connects to the output of several Pitney Bowes Document Inserting Systems, including the DI900 and DI950 inserters. It neatly stacks the mail pieces fed from the inserter and keeps them in the same order as they were originally loaded. Sensors in the stacker monitor the mail pieces fed into it; if a mail piece should stall or the stacker fills up, the inserter stops automatically.

The stacker is designed for continuous unloading during mail runs to maintain best productivity. Unloading "on-the-fly" keeps your mail run going and helps avoid unnecessary interruptions.

Refer to the *OptiFlow™ Vertical Power Stacker DIVS Operator Guide (SV61322)* for detailed information about the vertical power stacker.

OptiFlow™ Belt Stacker

Belt Stacker - Letter or Flats Mail

The OptiFlow™ Belt Stacker can be used in Right Angled or In Line configuration with the DI900 and DI950 inserters.

There are two setups for In Line operation: One for 'letters' (e.g. #10) sized envelopes, and another for 'flats' (e.g. #9) sized envelopes. In Line mode is essential for running 'flats'.

Tandem Belt Stacker - Letter and Flats Mail

A particular configuration of the stacker is available for the DI900 and DI950 inserters that allows automatic stacking of 'Letters' and 'Flats' simultaneously. The stacker consists of two stacker units mounted onto one set of legs or one table at the correct vertical spacing to receive 'Letter' and 'Flats' output from the Inserter.

Refer to the *OptiFlow™ Belt Stacker Operator Guide (SV40231)* for detailed information about the belt stacker and the tandem belt stacker.

Exit Transport

The Exit Transport assembly extends the path of the letter envelope exit beyond the distance needed for flats stacking below. The Exit Transport connects to the inserter and can be mounted to other output devices while maintaining flats envelope functionality.

The Exit Transport also provides optimum operator access to the High Capacity Envelope Feeder (HCEF) in certain configurations.

8 • Scanning

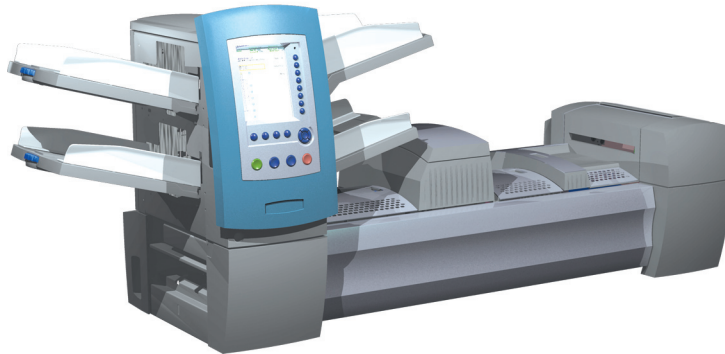

Scanning Overview.....	8-2
OMR	8-2
BCR	8-2
Scanning Features	8-4
Setting Up a New Scan Configuration	8-6
Setting Up an OMR Scan Configuration.....	8-6
Setting Up a BCR Scan Configuration.....	8-9
Editing a Scan Configuration	8-13
Editing an OMR Scan Configuration.....	8-13
Editing a BCR Scan Configuration	8-14
Copying a Scan Configuration.....	8-15
Deleting a Scan Configuration.....	8-15
Reviewing a Scan Configuration	8-16
Viewing the Job List.....	8-16
Assigning a Scan Configuration to an Existing Job	8-17
Adjusting the Scan Heads	8-19
Adjusting the Scan Heads for Ladder Orientation Marks	8-19
Adjusting the Scan Heads for Picket Orientation Marks.....	8-22
OMR Specifications	8-24
Barcode Specifications	8-26
Setting the OMR Scanning Area.....	8-29
Defining the First Mark Position and Code Length	8-29
Defining the Clear Zone.....	8-30
Additional Information.....	8-31
BCR and OMR Mark Levels	8-31
Basic Level	8-32
Enhanced Integrity Level	8-34
Selective Operations Level.....	8-35

Scanning Overview

The system offers two types of scanning; both types are optional features:

- Optical Mark Recognition (OMR)
- Barcode Recognition (BCR)

OMR

The purpose of OMR scanning is to ensure that a set of sheets that belongs together in a Mail Piece stays together as they make their way through the paper path and into the outer envelope. The benefits offered by use of the OMR feature include greatly increased Mail Piece integrity and an extremely low possibility of the wrong sheets being inserted into an envelope.

OMR mark criteria:

- Normally a dark solid line(s) that is printed on a sheet of white or light-colored paper (prior to being delivered to the system user for folding and inserting functions to make the Mail Pieces).
- The line runs (is printed) perpendicular to the direction of travel of the paper.
- The line is sufficiently thick and dense enough to trigger the OMR scanner on the system as it passes the scanner.
- OMR marks are generated in "ladder" orientation.

BCR

A barcode is a series of vertical bars and spaces that represent a numerical or alphanumeric series. Barcodes that may be used with this system are Code 3 of 9 and Interleaved 2 of 5.

Barcodes can be generated in "ladder" or "picket" orientation.



Direction of Feed: ↑ or ↓

Example: "Ladder" Orientation (OMR and BCR Marks)

BCR (continued)

Direction of Feed: ↑ or ↓

**Example: "Picket" Orientation (BCR Marks ONLY)**

NOTE: A HCSF is required to scan barcodes in "picket" orientation. "Picket" orientation uses a moving beam scanner. Only one moving beam scanner is present on a single HCSF.

Code 3 of 9 Barcode

Code 3 of 9 is an alphanumeric barcode. Each character is represented by five bars and four spaces, making a total of nine elements. Of these nine elements, three are wide and six are narrow. The space between characters is called the intercharacter gap. An asterisk is used as a start code and a stop code indicating where the data starts and ends. The start and stop codes allow the symbology to be read backwards and forwards.

PB FIRST™ uses Code 3 of 9 barcodes only.

Interleaved 2 of 5 Barcode

The Interleaved 2 of 5 (also called the I2of5 or ITF) is a numeric barcode. Start and stop characters are not required. Interleaving allows the characters to overlap, creating a higher density barcode than the Code 3 of 9. The symbology uses bars to represent the first character and the interleaved (white) spaces to represent the second character. Each character has two wide elements and three narrow elements.

The Interleaved 2 of 5 uses combinations of 2 of the 5 bars or spaces to create characters. The odd and even numbered characters encoded in the bars and spaces fit together like a puzzle. Interleaving or interlacing of the bars and spaces allows for a high-density, compact code. The UPC is a special type of Interleaved 2 of 5 barcode.

Scanning Features

Dynamic Envelope Selection

Dynamic envelope selection allows you to create scanning jobs on DI950 systems (with or without a High Capacity Sheet Feeder) that will insert mail piece contents into either letter-sized or flat envelopes.

Letter-sized envelopes are loaded at the High Capacity Envelope Feeder. Flat envelopes are loaded at the Feeder Tower, and can be linked so that they feed from Feeder A and Feeder C.

NOTE: You cannot use a windowed flat envelope with Top Address, Z folded jobs.

This feature is implemented in one of two ways:

- Using the Envelope Select (ES) scan mark. The Envelope Select scan mark is available on systems that have BCR scanning or the Selective Operations level of OMR scanning enabled. Refer to *BCR and OMR Mark Levels* in this chapter for more information about the various levels of scanning.
- Setting the “Item Overcount Action” to “Use Alternate Envelope”. Refer to *Creating a Job in Chapter 3* or *Assigning a Scan Configuration to an Existing Job* in this chapter for more information.

Jobs using dynamic envelope selection must be set up with two outer envelopes. The first set in the job must contain the information necessary to make the envelope selection (either the Envelope Select scan mark or “Item Overcount Action” setting). Secondary sets of scanned material, generic (non-scanned) material, or sets containing select fed sheets can be included in a dynamic envelope selection job.

Additionally, a single Reply Envelope (BRE) can be included in the job. If you wish to add an insert type other than a BRE to the flat envelope, the insert must be called a BRE in the Mail Piece Icon Tree.

NOTE: Thick inserts (such as booklets) may have trouble accumulating in the Pre-fold Accumulator and are not recommended for use.

The BRE/insert will accumulate with the flat set in the Pre-fold Accumulator prior to insertion into the envelope.

Currently, dynamic envelope selection cannot function with the Batch mode, or with any of the divert functionality.

Scanning Features (continued)

Divert Sheet Functionality

Divert sheet functionality allows you to create scanning jobs that will send sheets to the lower divert area if sets exceed a given sheet count or contain a specific scan mark.

This feature is implemented in one of two ways

- Using the Divert Sheets (DVS) scan mark. The Divert Sheet scan mark is available on systems that have BCR scanning or the Selective Operations level of OMR scanning enabled. Refer to *BCR and OMR Mark Levels* in this chapter for more information about the various levels of scanning.
- Setting the “Item Overcount Action” to “Divert”. Refer to *Creating a Job in Chapter 3* or *Assigning a Scan Configuration to an Existing Job* in this chapter for more information.

Jobs using the divert sheet functionality will send diverted sets to the lower divert area. The remaining parts of the mail piece will be processed, inserted into an outer envelope, and sent to the upper divert area.

NOTE: If the mail piece contains only a single set, which has been diverted, an empty envelope will be sent to the upper divert area.

Currently, the system can divert up to 25 sheets. If a set contains more than 25 sheets, the system will stop and you will need to manually remove sheets from the Pre-fold Accumulator and the remainder of the set from the appropriate Sheet Tray.

Divert sheet functionality cannot function with dynamic envelope selection at this time.

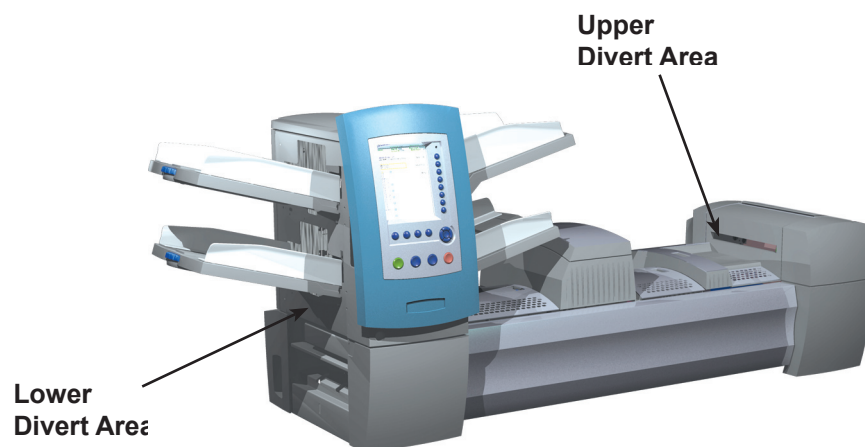

Setting Up a New Scan Configuration

When the job you are running includes scanning, you will need to:

- Have the BCR or OMR Scan Configuration Worksheet or some such listing of the required scan marks.
- Enter the settings into the Configurations screen for each item included in the job's Scan Configuration.
- Add the Scan Configuration to the job, so the system knows which items are scanned.

The BCR or OMR Scan Configuration Worksheet is a document prepared by the system supplier or someone who manages your system. This document contains information about scan marks for the job that you are running. You will need to enter this information in the appropriate Configuration screens.

NOTE: Entry of a access code or password from a Supervisor and/or Manager is required for use of these functions. Refer to *Access Rights* in *Chapter 2* in this guide for more information about logging in using the two security modes.

Setting Up an OMR Scan Configuration

To setup an OMR Scan Configuration:

1. From the Home screen, select "Menu" then "Tools".
2. Select "Configure System" then "Scan Configuration Setup".

NOTE: If you are not logged in with supervisor or manager access rights, you will be prompted to enter an access code.

3. Select "OMR".
4. The Scan Configuration Setup screen displays. Select "Create New Item".
5. Enter the Scan Configuration name using the alphanumeric matrix. Press "Finished" when you are done.

NOTE: The Scan Configuration name cannot be longer than 9 characters. Additionally, all names must be unique across all scan types. That is, an OMR Scan Configuration name cannot be the same as a BCR Scan Configuration name.

6. The Create OMR screen displays. Select "Add Item".

Setting Up an OMR Scan Configuration (continued)

7. The Add OMR Functions screen displays. There are two lists available on the screen: Selected Functions and Available Functions. Refer to *BCR and OMR Mark Levels* in this chapter for a brief description of the function of each mark.

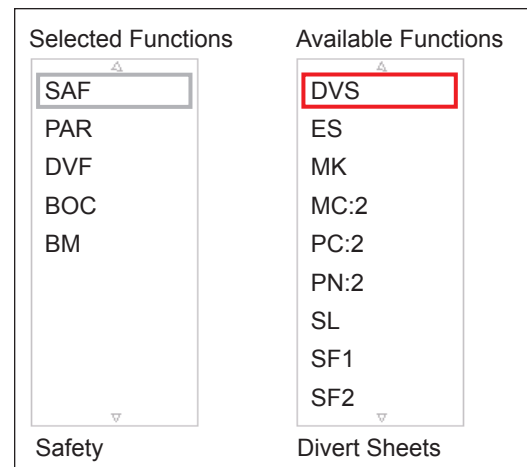

Selected and Available Lists

NOTE: Items that can be added appear in the Available list. Items that have been added appear in the Selected list.

- Use the LEFT/RIGHT arrow keys to move between lists.
 - Use the UP/DOWN arrow keys to highlight an item within a list.
- a. Highlight the appropriate item in the Available list, then select "Add Highlighted Item". The item you selected in the Available list will move to the end of the Selected list.
 - b. Repeat step a, above, until all necessary items have been added to the Selected list.
 - c. Press "Finished" when you are done.
8. The Create OMR screen displays. Use the UP/DOWN arrows to highlight an item in the OMR Marks list. (This list contains items added in step 7.)
 9. Select "Set Options for Highlighted Item".

NOTE: The options that appear vary, depending upon the selected function.

Menu Option	Associated Options/Actions
Increase Count for Highlighted Item (MC, WAS only)	Allows you to increase the number of marks for the function. The count number is appended to the abbreviation (e.g. MC1, MC2, MC3).
Decrease Count for Highlighted Item (MC, WAS, PC, PN only)	Allows you to decrease the number of marks for the function. The count number is appended to the abbreviation (e.g. MC3, MC2, MC1).
Use When	Toggles: <ul style="list-style-type: none"> • Present, or • Absent. When <i>Present</i> is selected, the function will be performed when mark is printed. When <i>Absent</i> is selected, the function will be performed when the mark location is blank.

Setting Up an OMR Scan Configuration (continued)

Menu Option	Associated Options/Actions
Count Direction <i>(Multi-bit only)</i>	<p>Allows you to specify the count direction.</p> <ul style="list-style-type: none"> • Up (default), • Down, or • Random (MC only). <p>When <i>Up</i> is selected, the relevant code's binary value will increase as the system scans each page.</p> <p>When <i>Down</i> is selected, the relevant code's binary value will decrease as the system scans each page.</p>
Is Controlling	<p>Determines if the selected function controls where collations end, or indicates error checking.</p> <p>Toggles:</p> <ul style="list-style-type: none"> • Yes (default) • No <p>NOTES:</p> <ul style="list-style-type: none"> • Only one function can be controlling. Selecting "Yes" will set all other functions to "No". • This option will display for BOC <i>only</i> when an HCSF is present. • When MC is controlling, the "PC Control" option is set to "No" and becomes inactive. • If the Scan Configuration will be used with a closed-loop SureTrac Job or with the Attached Printer, then MC <i>must</i> be controlling. This tells the inserter that SureTrac will provide the control instructions to the inserter based on the MC read on each document and defines this as a closed-loop Scan Code definition.
Wrap At <i>(Multi-bit only)</i>	<p>Displays "Wrap At" numeric entry screen, where you enter the maximum code value in decimal format.</p> <ul style="list-style-type: none"> • If the count direction is <i>Up</i>, the next code after this value will be 0 or 1, depending on the Includes Zero setting. • If the count direction is <i>Down</i>, the code should jump to this value after 0 or 1. <p>This field can contain up to seven digits.</p>
Includes Zero <i>(Multi-bit only)</i>	<p>Allows you to specify whether the sequence should include zero.</p> <p>Toggles:</p> <ul style="list-style-type: none"> • Yes (default), or • No. <p>When <i>Yes</i> is selected for the Include Zero option, the relevant code's binary value would allow zero, which is represented by no marks being printed within that section of the code.</p> <p>When <i>No</i> is selected for the Include Zero, the relevant code will NOT include zero as a value. Therefore, a mark will ALWAYS be printed within that section of the code for OMR.</p>

Setting Up an OMR Scan Configuration (continued)

Menu Option	Associated Options/Actions
LSB	Allows you to specify the least significant bit. Toggles: <ul style="list-style-type: none"> • Last (default, farthest from top of page), or • First. When <i>First</i> is selected for the Least Significant Bit option, the least significant bit is closest to the top of the page. When <i>Last</i> is selected, the least significant bit is farthest from the top of the page.

10. Select "Finished" once you have set all of the necessary options for the function.
11. Repeat steps 8 to 10 for each additional function on the OMR Scan Configuration Worksheet.
12. Select "Finished" on the Create Scan Code screen once you have entered and set up all of the functions.

Setting Up a BCR Scan Configuration

To setup a BCR Scan Configuration:

1. From the Home screen, select "Menu" then "Tools".
2. Select "Configure System" then "Scan Configuration Setup".

NOTE: If you are not logged in with supervisor or manager access rights, you will be prompted to enter an access code.

3. Select the appropriate BCR Scan Type:
 - Code 3 of 9
 - Interleaved 2 of 5.
4. The Scan Configuration Setup screen for your selection displays. Select "Create New Item".
5. Enter the Scan Configuration name using the alphanumeric matrix. Press "Finished" when you are done.

NOTE: The Scan Configuration name cannot be longer than 9 characters. Additionally, all names must be unique across all scan types. That is, a BCR Scan Configuration name cannot be the same as an OMR Scan Configuration name.

Setting Up a BCR Scan Configuration (continued)

6. The Create Scan Code screen appears. Enter the character, bit and size information on the BCR Scan Configuration Worksheet for a function.

Refer to *BCR and OMR Mark Levels* in this chapter for a brief description of the function of each mark.

- a. Use the UP/DOWN and LEFT/RIGHT arrow keys to highlight an item within the grid.
- b. Press "Increase" or "Decrease" to edit the character (C), bit (B) and size (S) information for a specific function (F).

F	C	B	S
MC	3	4	2
WAS	5	4	2
EOC	7	0	1
SF1	8	0	1
DVF	9	0	1

Scan Grid

NOTES:

- On the BCR Scan Configuration Worksheet, look for the function abbreviation in the "Function" column. Enter the associated character information in the "C" column, the bit information in the "B" column and, if necessary, the size information in the "S" column.
- Bit 0 is the right-most bit (least significant) in each character:
 - For Code 3 of 9 barcodes, bits are 5, 4, 3, 2, 1, and 0.
 - For Interleaved 2 of 5 barcodes, bits are 2, 1, 0.
- Items with Character set to zero will not be included in the final code.
- For multi-bit fields, the entry in the "S" column depends on the code type. For Bin, "S" is the number of bits. For CCD, "S" is the number of characters.

7. Select "Set Options". Use the table below to set the necessary options.

NOTE: The options that appear vary, depending upon the selected function.

Menu Option	Associated Options/Actions
Use When	Toggles: <ul style="list-style-type: none"> • Present, or • Absent. When <i>Present</i> is selected, the function will be performed when the bit is "1". When <i>Absent</i> is selected, the function will be performed when the bit is "0".
Count Direction	Allows you to specify the count direction. <ul style="list-style-type: none"> • Up (default), • Down, or • Random (MC only). When <i>Up</i> is selected, the relevant code's binary value will increase as the system scans each page. When <i>Down</i> is selected, the relevant code's binary value will decrease as the system scans each page.

**Setting Up
a BCR Scan
Configuration
(continued)**

Menu Option	Associated Options/Actions
Is Controlling	<p>Determines if the selected function controls where collations end, or indicates error checking.</p> <p>Toggles:</p> <ul style="list-style-type: none"> • Yes (default for EOC) • No <p>NOTES:</p> <ul style="list-style-type: none"> • Only one function can be controlling. Selecting "Yes" will set all other functions to "No". • If the Scan Configuration will be used with a closed-loop SureTrac Job or with the Attached Printer, then MC <i>must</i> be controlling. This tells the inserter that SureTrac will provide the control instructions to the inserter based on the MC read on each document and defines this as a closed-loop Scan Code definition.
Code Base	<p>Allows you to specify the numeric value for the code base. The minimum value is 2, and the maximum value is 43. The default value is 32.</p> <p>For codes that span more than one character, this sets the value where each character resets to zero and carries to the next character.</p>
Code Type	<p>Select the appropriate code type:</p> <ul style="list-style-type: none"> • BIN (for most single-bit functions) • CCD (for most multi-bit functions) • XCD (for minimum code size, this selection allows multibit fields to span partial characters) <p>These coding type options are intended to be consecutive numbers that either count up or count down. They allow the system to count up to a maximum, or down to either one or zero and wraps at/to a defined maximum value.</p> <p><i>BIN</i> is a straight binary string. It is loaded into the barcode construct at the starting bit position until all bits have been assigned.</p> <p><i>CCD</i> is a character-based field aligned with character boundaries for human readability. This number must be less than 43. Recommended options for Code 3 of 9 barcodes are: 10, 32, or 36. Base number must be 10 for Interleaved 2 of 5 barcodes.</p> <p><i>XCD</i> provides minimum code size at the expense of human readability. It allows multi-bit fields to span partial characters.</p>
Wrap At	<p>Displays "Wrap At" numeric entry screen, where you enter the maximum code value in decimal format.</p> <ul style="list-style-type: none"> • If the count direction is <i>Up</i>, the next code after this value will be 0 or 1, depending on the Includes Zero setting. • If the count direction is <i>Down</i>, the code should jump to this value after 0 or 1. <p>This field can contain up to 10 digits.</p>

Setting Up a BCR Scan Configuration (continued)

Menu Option	Associated Options/Actions
Includes Zero	<p>Allows you to specify whether the sequence should include zero.</p> <p>Toggles:</p> <ul style="list-style-type: none"> • Yes (default), or • No. <p>When <i>Yes</i> is selected for the Include Zero option, the relevant code's binary value would allow zero, which is represented by no marks being printed within that section of the code.</p> <p>When <i>No</i> is selected for the Include Zero, the relevant code will NOT include zero as a value.</p>
LSB	<p>Allows you to specify the least significant bit.</p> <p>Toggles:</p> <ul style="list-style-type: none"> • Last (default, farthest from start of code), or • First. <p>When <i>Last</i> is selected for the Least Significant Bit option, the code is in the normal order, with the least significant bit is closest to the right-hand end of the string.</p> <p>When <i>First</i> is selected, which is very uncommon, the bits are reversed.</p>

8. Select "Finished" once you have set all of the necessary options for the function.
9. Repeat steps 6 to 8 for each additional function on the BCR Scan Configuration Worksheet.
10. Select "Scan Mark" to toggle the appropriate mark orientation (ladder or picket), as indicated on the BCR Scan Configuration Worksheet.

NOTE: "Picket" orientation is only available when a HCSF is equipped specifically to support this option.

11. Select "PC Control" to toggle the appropriate option (Yes or No).

NOTE: When PC Control is set to "Yes", the scan grid is grayed out. Additionally, the "Increase", "Decrease", and "Set Options" menu items are unavailable.

12. Select "Finished" on the Create Scan Code screen once you have entered and set up all of the functions.

Editing a Scan Configuration

Editing an OMR Scan Configuration

To edit an OMR Scan Configuration:

1. From the Home screen, select "Menu" then "Tools".
2. Select "Configure System" then "Scan Configuration Setup".

NOTE: If you are not logged in with supervisor or manager access rights, you will be prompted to enter an access code.

3. Select the appropriate scan type.
4. The Scan Configurations for the selected scan type display. Use the UP/DOWN arrow keys to select the Scan Configuration you want to edit.
5. Select "Edit Highlighted Item".
6. The screen displays the functions list for the selected Scan Configuration. You can:

Menu Option	Associated Options/Actions
Add Item	<p>Allows you to add a mark to the selected Scan Configuration.</p> <ol style="list-style-type: none"> a. Highlight the appropriate item in the Available list, then select "Add Highlighted Item". The item you selected in the Available list will move to the end of the Selected list. b. Repeat step a, above, until all necessary items have been added to the Selected list. c. Press "Accept" when you are done. <p>Once you have added the mark, be sure to set the appropriate options. Refer to the <i>Set Options</i> table in the <i>Setting Up a OMR Scan Configuration</i> section of this chapter for more information</p> <p>NOTES:</p> <ul style="list-style-type: none"> • Items that can be added appear in the <i>Available</i> list. Items that have been added appear in the <i>Selected</i> list. • Use the LEFT/RIGHT arrow keys to move between lists. Use the UP/DOWN arrow keys to move within a list
Delete Highlighted Item	<p>Allows you to delete a mark within the selected Scan Configuration:</p> <ol style="list-style-type: none"> a. Use the UP/DOWN arrow keys to select the appropriate mark within the function list. b. Select "Delete Highlighted Item". c. Select "Yes, Delete Item".
Move Highlighted Item Up	Allows you to move the selected mark up within the function list.
Move Highlighted Item Down	Allows you to move the selected mark down within the function list
Set Options	Allows you to edit the options for the selected mark. Refer to the <i>Set Options</i> table in the <i>Setting Up a OMR Scan Configuration</i> section of this chapter for more information

7. Select "Finished" when you are done.

Editing a BCR Scan Configuration

To edit a BCR Scan Configuration:

1. From the Home screen, select "Menu" then "Tools".
2. Select "Configure System" then "Scan Configuration Setup".

NOTE: If you are not logged in with supervisor or manager access rights, you will be prompted to enter an access code.

3. Select the appropriate scan type.
4. The Scan Configurations for the selected scan type display. Use the UP/DOWN arrow keys to select the Scan Configuration you want to edit.
5. Select "Edit Highlighted Item".
6. The screen displays the scan grid with the available BCR functions for the selected Scan Configuration. You can:

Menu Option	Associated Options/Actions
Increase	Allows you to increase the selected character, bit or size for a function. <ol style="list-style-type: none"> a. Use the UP/DOWN and LEFT/RIGHT arrow keys to highlight the character (C), bit (B) or size (S) within the grid. b. Press "Increase" to edit the information for the highlighted item.
Decrease	Allows you to decrease the selected character, bit or size for a function. <ol style="list-style-type: none"> a. Use the UP/DOWN and LEFT/RIGHT arrow keys to highlight the character (C), bit (B) or size (S) within the grid. b. Press "Decrease" to edit the information for the highlighted item.
Set Options	Allows you to edit the options for the selected mark. Refer to the <i>Set Options</i> table in the <i>Setting Up a BCR Scan Configuration</i> section of this chapter for more information
Scan Mark	Allows you to toggle the appropriate mark orientation: <ul style="list-style-type: none"> • Ladder, or • Picket.
PC Control	Allows you to toggle whether or not the PC Control is used: <ul style="list-style-type: none"> • Yes, or • No.

7. Select "Finished" when you are done.

Copying a Scan Configuration

If necessary, you can save a copy of a selected Scan Configuration under a new name. This feature permanently saves the current Scan Configuration setup as a new Scan Configuration with a different name.

NOTES:

- The "Copy Highlighted Item" option is unavailable if the maximum number of stored Scan Configurations (24) is reached.
- The same scan type is used.

-
1. From the Home screen, select "Menu" then "Tools".
 2. Select "Configure System" then "Scan Configuration Setup".

NOTE: If you are not logged in with supervisor or manager access rights, you will be prompted to enter an access code.

-
3. Select the appropriate scan type.
 4. The Scan Configurations for the selected scan type display. Use the UP/DOWN arrow keys to select the Scan Configuration you want to copy.
 5. Select "Copy Highlighted Item".
 6. The Save Scan Configuration As screen displays. Use the *alphanumeric matrix* to enter the new Scan Configuration name.
 7. Select "Finished" when you are done.

Deleting a Scan Configuration

If necessary, you can delete a Scan Configuration from the system. *A Scan Configuration cannot be deleted if it is a library Scan Configuration, associated with a library job, or if it is used by a saved job.*

NOTE: To see which jobs use a given Scan Configuration, view the job list. Refer to *Viewing the Job List* in this chapter for more information. If necessary, you can remove the association with a saved job via the Edit Job function for the job(s) listed in the dialog, and then delete the Scan Configuration. Refer to *Editing a Job* in *Chapter 3* for more information.

-
1. From the Home screen, select "Menu" then "Tools".
 2. Select "Configure System" then "Scan Configuration Setup".

NOTE: If you are not logged in with supervisor or manager access rights, you will be prompted to enter an access code.

-
3. Select the appropriate scan type.
 4. The Scan Configurations for the selected scan type display. Use the UP/DOWN arrow keys to select the Scan Configuration you want to delete.
 5. Select "Delete Highlighted Item".
 6. One of the following will occur:
 - If the Scan Configuration meets the requirements for deletion, the Confirm Delete prompt displays. Select "Yes, delete item".

NOTE: Deleted Scan Configurations cannot be restored by pressing "Cancel" from this screen.

-
- If the Scan Configuration does not meet the requirements for deletion, the Cannot Delete Scan Configuration dialog displays. Select "Close".

Reviewing a Scan Configuration

If necessary, you can view a list of marks associated with the Scan Configuration without entering the Edit mode.

NOTE: This option is only available if the PC Control is set to "No".

1. From the Home screen, select "Menu" then "Tools".
2. Select "Configure System" then "Scan Configuration Setup".

NOTE: If you are not logged in with supervisor or manager access rights, you will be prompted to enter an access code.

3. Select the appropriate scan type.
4. The Scan Configurations for the selected scan type display. Use the UP/DOWN arrow keys to select the Scan Configuration you want to review.
5. Select "Review Highlighted Item".
6. The Review Scan Code screen displays. The marks associated with the configuration appear in the Functions list. Use the UP/DOWN arrow keys to select the Function you want to review.
7. Select "Finished" once you have reviewed the list.

Viewing the Job List

Allows you to view the jobs associated with the selected Scan Configuration.

NOTE: This option is not available if there are no jobs associated with the selected Scan Configuration.

1. From the Home screen, select "Menu" then "Tools".
2. Select "Configure System" then "Scan Configuration Setup".

NOTE: If you are not logged in with supervisor or manager access rights, you will be prompted to enter an access code.

3. Select the appropriate scan type.
4. The Scan Configurations for the selected scan type display. Use the UP/DOWN arrow keys to select the Scan Configuration with the job list you want to view.
5. Select "View Job List for Highlighted Item".
6. The View Job List screen displays. Use the UP/DOWN arrow key to scroll through the job list.
7. Select "Cancel" to return to the Scan Configuration screen.

Assigning a Scan Configuration to an Existing Job

Follow the steps in this section to assign a Scan Configuration to an existing job (either the current job, or another job) that has been created previously.

1. From the Home screen, select "Menu", "Jobs", then select:
 - "Edit Current Job", or
 - "Select Job", then the appropriate job from the list that appears.
2. If the Scan Configuration uses dynamic envelope selection, the existing job must have a second outer envelope. To add an outer envelope:
 - a. Select "Add Outer Envelope".
 - b. Select the appropriate options.
 - c. Select "Accept" when done.
3. Use the UP/DOWN arrow keys to select the appropriate item (sheet or insert) in the Mail Piece Icon Tree.
4. Select "Edit Highlighted Item".
5. Select "Additional Settings".
6. Select "Scan Item" and toggle "Yes".
7. Select "Scan Settings".
8. The Select Scan Type screen displays. Select the appropriate scan type (OMR, Code 3 of 9, or Interleaved 2 of 5).
9. Select the appropriate scan configuration name from the list that appears. If necessary, select "Next" or "Previous" to move forward or backward through the list.
10. The Scan Settings screen displays.

Menu Option	Associated Options/Actions
Content in Line with Marks	Allows you to toggle whether or not the content is in line with the scan marks in the feed direction: <ul style="list-style-type: none"> • Yes, or • No.
Marks on	Allows you to toggle which side of the page the marks appear on: <ul style="list-style-type: none"> • Front (address side), or • Back.
Marks on First Page Only	Allows you to toggle whether or not the marks appear only on the first of multiple sheets: <ul style="list-style-type: none"> • Yes, or • No.

Assigning a Scan Configuration to an Existing Job (continued)

Menu Option	Associated Options/Actions
<p>Mark Location Settings</p> <p>NOTE: This option is disabled when Content in Line with Marks is set to "No" and the Scan Configuration contains multi-mark with fixed first and last mark.</p>	<p>Allows you to setup various OMR mark-related measurements:</p> <ul style="list-style-type: none"> • <i>Top of Page to First Mark</i> is the distance from the top of the page to the first mark. • <i>Total Length of Marks</i> is the length from the top of the first possible mark to the bottom of the last mark. • <i>Top of Page to Clear Zone</i> is distance from the top of the page to the beginning of the Clear Zone. • <i>Length of Clear Zone</i> is the distance from the top of the Clear Zone to the first mark. <p>Follow the steps below to enter the various mark-related measurements:</p> <ol style="list-style-type: none"> a. Select an option, then use the UP/DOWN arrow keys to enter the appropriate measurement (in millimeters). b. Press "Accept" when you are done entering the measurement. c. Once <i>all</i> measurements have been entered, select "Accept" to return to the Scan Settings screen. <p>NOTE: For more information about determining each of the above measurements, refer to <i>OMR Specifications</i> in this chapter.</p>
<p>Item Over Count Quantity</p>	<p>Allows you to select the number of items that cannot be run normally.</p> <ol style="list-style-type: none"> a. Use the UP/DOWN arrow keys to enter the item over count quantity. b. Select "Accept" when you are done. <p>NOTE: At this time, only a single scanned insert can be added to each mail piece. The scanned insert must be a Reply Envelope (BRE).</p>
<p>Item Over Count Action</p>	<p>Allows you to select what will happen to items that exceed the item over count quantity. Choices include:</p> <ul style="list-style-type: none"> • <i>Divert</i> – Select this option if the Scan Configuration does not have the Divert Sheet (DVS) scan mark, and you want the system to divert items once the item over count quantity has been exceeded. • <i>Stop</i> - Select this option if you want the system to stop processing items once the item over count quantity has been exceeded. • <i>Use Alternate Envelope</i> – Select this option if the Scan Configuration does not have the Envelope Select (ES) scan mark, and you want the system to use an alternate envelope for items that exceed the item overcount quantity. <p>Refer to <i>Scanning Features</i> in this chapter for more information on dynamic envelope selection and divert sheet functionality.</p>

Assigning a Scan Configuration to an Existing Job (continued)

11. Once the scan settings have been entered, select "Accept" to return to settings screen for the sheet or insert.
12. Select "Select Feed Setting" and choose the appropriate feeder setting for the item (none, SF1, SF2, SF3, SF4, SF5, SF6, SF7, SF8 or SF9).
13. When you are done:
 - Press "Accept" to back through the configure system screens and return to the Home screen. Your settings will be saved.
 - OR
 - Press HOME to save your adjustments and return directly to the Home screen.

Adjusting the Scan Heads

Once the system administrator or system supplier sets up the Scan Configuration, the key to maximizing barcode or OMR performance lies in proper adjustment/positioning of the Scan Heads to be able to read the mark.

The Scan Heads are located in the Feeder Tower or the HCSF (if present on your system.) There are two Scan Heads in either location. This allows the system to read the mark regardless of the mark's location on the sheet.

Additionally, more than one sheet within a set can be marked. If multiple sheets are using the same Scan Head, the marks on each sheet must be oriented so they pass over the Scan Head in the same position.

If both Scan Heads are used, they must be offset by at least 20 mm (0.787") to avoid errors.

IMPORTANT: The Side Guides must be set properly in order for the Scan Heads to read the marks correctly. Additionally, material must be jogged back into place and loaded as an even stack to ensure the Scan Head and marks align properly. Refer to *Loading Material into the Trays* in *Chapter 3* of this guide for more information.

Adjusting the Scan Heads for Ladder Orientation Marks

To adjust the scan heads:

1. Fold one of the sheets to be scanned in half vertically (side with mark facing up.)
2. Draw two arrows, one at the top of the mark, and one at the bottom of the mark, pointing towards the top of the sheet.

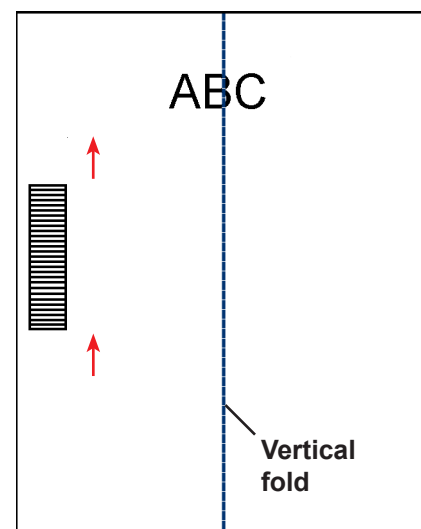

Adjusting the Scan Heads for Ladder Orientation Marks (continued)

3. Fold the sheet horizontally, so the barcode appears on either side of the fold line.
4. Open the Main Transport Deck Cover. Use the ruler to measure the distance from the center of the sheet (lined up at 0 on the ruler) to the center of the marks.
5. Refer to the loading instructions to determine:
 - The Scan Head location to be used for this sheet (Left or Right)
 - If the sheet will be loaded Top or Bottom first.

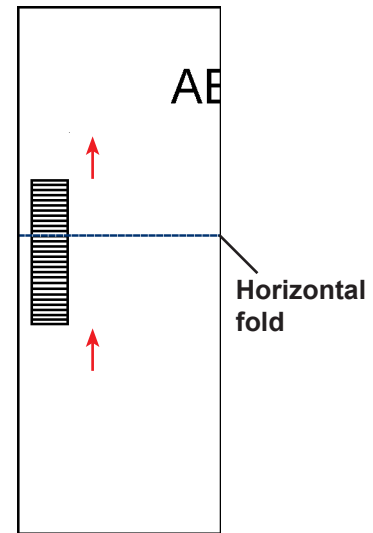

6. Open the Tower cover:
 - If the scanner is in the Feeder Tower (Feeders A, B, C, D) open the Feeder Tower cover
 - If the scanner is in the HCSF (High Capacity Sheet Feeder J, K, L, M), open the HCSF Tower cover.

TIPS:

- Remove the left Feeder Trays from the Feeder Tower to allow the HCSF Tower cover to open freely.
 - If you have two HCSFs on your system, the first HCSF Tower will prevent the second tower (farthest) from opening fully. For best results, be sure you have proper lighting when adjusting the Scan Head in the second tower.
-
7. Determine the direction the Scan Head needs to be moved (to the left or right of 0 on the ruler):
 - Make sure the center of the sheet (the vertical fold) is lined up with the at the center of the machine (at 0 on the ruler.)
 - If the sheet is loaded Top First, make sure the arrows point DOWN.
 - If the sheet is loaded Bottom First, make sure the arrows point UP.

Adjusting the Scan Heads for Ladder Orientation Marks (continued)

8. Use the blue thumbwheel to move the Scan Head.

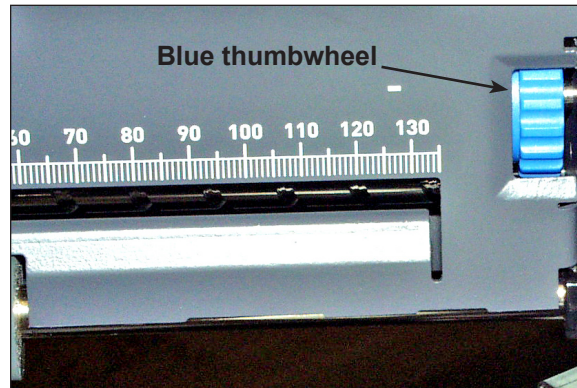

Figure 8.1: Use the Blue Thumbwheel to Adjust Scan Head Position

Move the thumbwheel until the pointer lines up with the measurement (distance from the center of the page to the center of the mark) defined in Step 7.

Move thumbwheel until pointer lines up with the distance measured in Step 4.

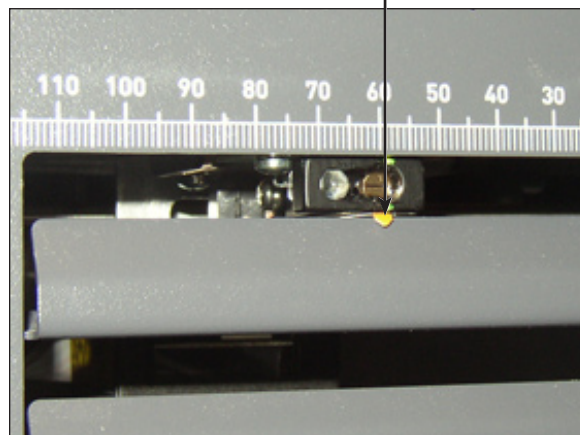

Figure 8.2: Use the Pointer to Ensure Correct Scan Head Position

9. If additional Scan Heads are to be used, repeat step 1 to 8 for each.
10. To verify the adjustment is correct:
 - a. From the home screen, select “Loading Instructions and Pre-Run Adjustments” then “Scanner Setup”.
 - b. Use the UP/DOWN arrow keys to select a feeder to run.
 - c. Press TRIAL PIECE to feed a piece from the highlighted feeder.
 - d. Select “Finish” when done.

Adjusting the Scan Heads for Picket Orientation Marks

To adjust the scan heads:

1. Fold one of the sheets to be scanned in half vertically (side with mark facing up.)
2. Draw two arrows, one at the top of the mark, and one at the bottom of the mark, pointing towards the top of the sheet.

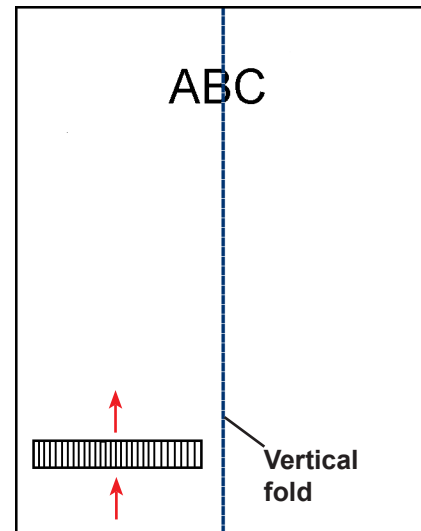

3. Fold the sheet horizontally, so the barcode appears on either side of the fold line.
4. Open the Main Transport Deck Cover. Use the ruler to measure the distance from the center of the sheet (lined up at 0 on the ruler) to the center of the marks.
5. Refer to the loading instructions to determine:
 - The Scan Head location to be used for this sheet (Left or Right)
 - If the sheet will be loaded Top or Bottom first.

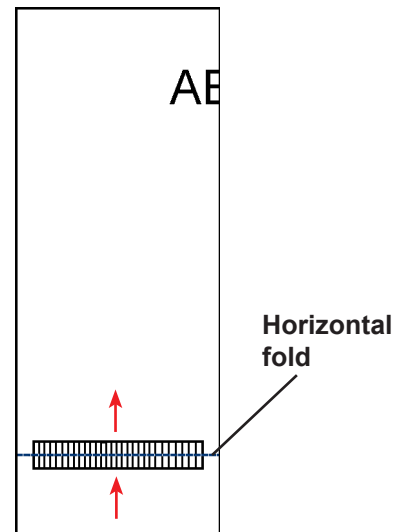

6. Open the HCSF Tower cover.

TIPS:

- Remove the left Feeder Trays from the Feeder Tower to allow the HCSF Tower cover to open freely.
- If you have two HCSFs on your system, the first HCSF Tower will prevent the second tower (farthest) from opening fully. For best results, be sure you have proper lighting when adjusting the Scan Head in the second tower.

Adjusting the Scan Heads for Picket Orientation Marks (continued)

7. Determine the direction the Scan Head needs to be moved (to the left or right of 0 on the ruler):
 - Make sure the center of the sheet (the vertical fold) is lined up with the at the center of the machine (at 0 on the ruler.)
 - If the sheet is loaded Top First, make sure the arrows point DOWN.
 - If the sheet is loaded Bottom First, make sure the arrows point UP.
8. Use the blue thumbwheel to move the Scan Head.

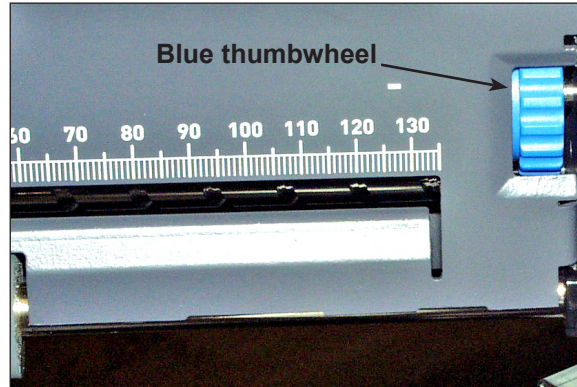

Figure 8.3: Use the Blue Thumbwheel to Adjust Scan Head Position

Move the thumbwheel until the pointer lines up with the measurement (distance from the center of the page to the center of the mark) defined in Step 7.

9. If additional Scan Heads are to be used, repeat step 1 to 8 for each.

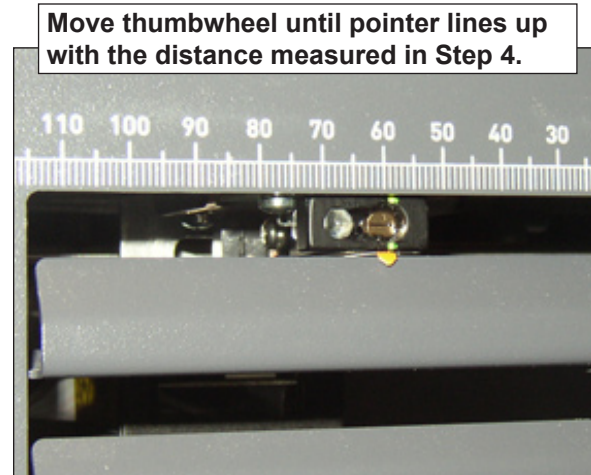

Figure 8.4: Use the Pointer to Ensure Correct Scan Head Position

10. To verify the adjustment is correct:
 - a. From the home screen, select “Loading Instructions and Pre-Run Adjustments” then “Scanner Setup”.
 - b. Use the UP/DOWN arrow keys to select a feeder to run.
 - c. Press TRIAL PIECE to feed a piece from the highlighted feeder.
 - d. Select “Finish” when done.

OMR Specifications

- For best line discrimination, maintain a 5 to 1 light to dark space ratio. This means the spacing between lines must be at least 6 times the width of and limits the maximum allowable line thickness to .635 mm (0.025").
- Marks may be printed as four or five underscore characters (_____) in a row, with one mark per print line. Another method of generating marks is to draw a minimum 10 mm line using graphic commands in the desired location.
- All of the mark locations used shall be located together. One mark cannot be on the top of the page with another located on the bottom of the page.
- OMR marks can appear anywhere within the white regions shown on the next page. The most common locations for OMR marks are along the edges of the paper, or along the edge of the address block.
- The mark must be a solid black line between 0.002" (0.254 mm or 1 point) and 0.05" (1.25 mm or 3.54 points) thick, and at least 0.4" wide (10.16 mm).

Too Thin: 0.127 mm (0.5 point) 

Minimum: 0.254 mm (1 point) 

Maximum: 1.25 mm (3.54 points) 

} **Acceptable
Thickness
Range**

NOTE: Due to limitations of the reprographic process, the examples above are not exact. However, they are accurate enough to show the relative difference between acceptable and unacceptable OMR mark thicknesses.

- Each mark position must be evenly spaced and at least 0.125" (3.175 mm) and no more than 0.167" (4.2 mm) apart.
- The maximum number of mark positions allowed within the code is 19; this includes ignored marks. The total length of the OMR code should not exceed 3.5" (89 mm).
- On the HCSF: the center line of the marks must fall within a range of 1.25" (32 mm) to 4.125" (105 mm) from the center line of the sheet.
On the Feeder Tower: the center line of the marks must fall within a range of 0.787" (20 mm) to 4.92" (125 mm) from the center line of the sheet.
- The first bar of the OMR marks should not be closer than .79" (20 mm) from the Lead Edge. The last bar of the OMR marks should not be closer than .79" (20 mm) from the Trail Edge of the sheet.

NOTE: Currently, *for best results*, the OMR marks should not be closer than 1.77" (45 mm) from the Trail Edge of the sheet.

- The area around the marks should be kept clear from print, etc. that may be read by the scanner in error; this area is called the Clear Zone. The Clear Zone must be at least .12" (3 mm) on each side of the marks, **.38"** (9 mm) before the first mark and **.38"** (9 mm) after the last mark.

NOTE: The system only accepts Clear Zone measurements in millimeters.

- There should be no print on the reverse of the sheet immediately behind the Clear Zone.

OMR Specifications (continued)

OMR Mark Specification Diagram (Diagram is not to scale)

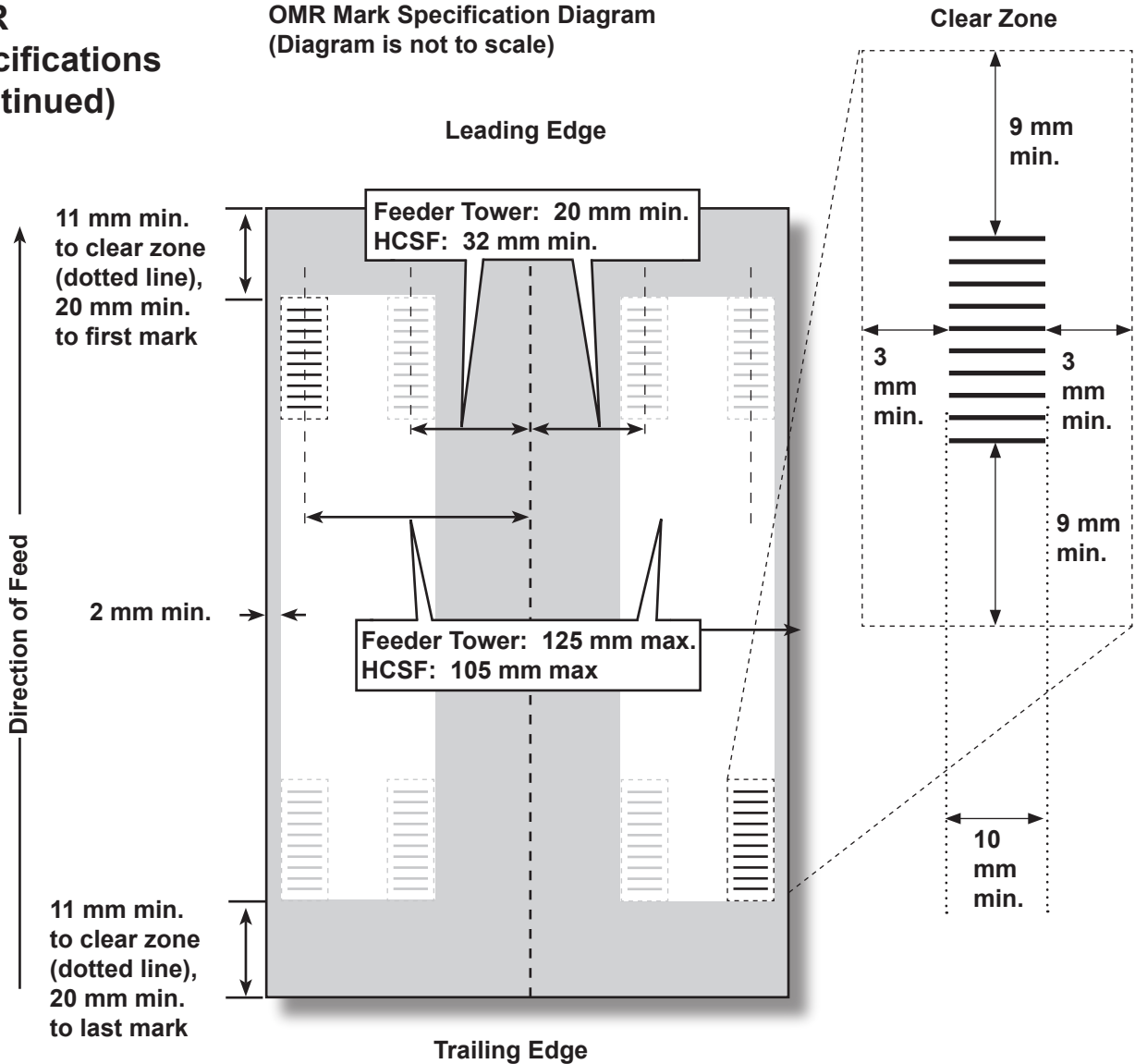

OMR Mark Specs at a Glance			
Description	Metric	English	Closest Fraction
Minimum line width for OMR or barcode marks	10mm	0.40"	7/16"
Minimum spacing between OMR marks	2.5mm	0.10"	1/10"
Maximum spacing between OMR marks	4.5mm	0.18"	3/16"
Minimum space between mark clear zone and paper edge	11mm	0.42"	7/16"
Minimum clear zone on sides of marks	3mm	0.12"	1/8"
Minimum clear zone on tops of marks	9mm	0.38"	3/8"
Distance from top of sheet to first mark	20mm	0.79"	3/4"
Distance from bottom of sheet to last mark	20mm*	0.79"	3/4"
Maximum length of code	89mm	3.50"	3-1/2"

Barcode Specifications

- Code 39 and Interleaved 2 of 5 (I 2 of 5) are supported. Extended Code 39 is not permitted. Barcode symbologies without start and stop characters and internal integrity features such as I 2 of 5 should use a checksum byte.
- Maximum length 12 characters (14 including start and stop) for Code 39
Maximum length 18 characters for I 2 of 5
- Barcodes can appear anywhere within the white regions shown on the next page(s). The most common locations for barcodes are along the edges of the paper, or along the edge of the address block.
- Barcodes must be printed on every page. They can be on either the front (address side) or back of the page.
- All the information to be scanned must be in one barcode.
- Bits or characters for multibit functions must be adjacent (contiguous).
- Barcode lines must be at least 10 mm (3/8 in) long. Longer is better because it makes the scanner position less critical.
- Maximum code length: 89 mm (3.5 in)
- *On the HCSF:* the center line of the barcode must fall within a range of 1.25" (32 mm) to 4.125" (105 mm) from the center line of the sheet.
On the Feeder Tower: the center line of the barcode must fall within a range of 0.787" (20 mm) to 4.92" (125 mm) from the center line of the sheet.
- The barcode should not be closer than .79" (20 mm) from the Lead Edge nor closer than .79" (20 mm) from the Trail Edge of the sheet.

NOTE: Currently, *for best results*, the barcode should not be closer than 1.77" (45 mm) from the Trail Edge of the sheet.

- The area around the barcode should be kept clear from print, etc. that may be read by the scanner in error; this area is called the Clear Zone. The Clear Zone must be at least .12" (3 mm) on each side of the barcode.

NOTE: The system only accepts Clear Zone measurements in millimeters.

- There should be no print on the reverse of the sheet immediately behind the Clear Zone.
- Narrow bar width shall be between 0.275 mm and 0.635 mm thick inclusive.
- Narrow space width should equal narrow bar width. Narrow to wide elements shall have a 3 to 1 ratio.
- Picket barcode requires the HCSF with the moving beam scanner option.

Barcode Specifications
(continued)

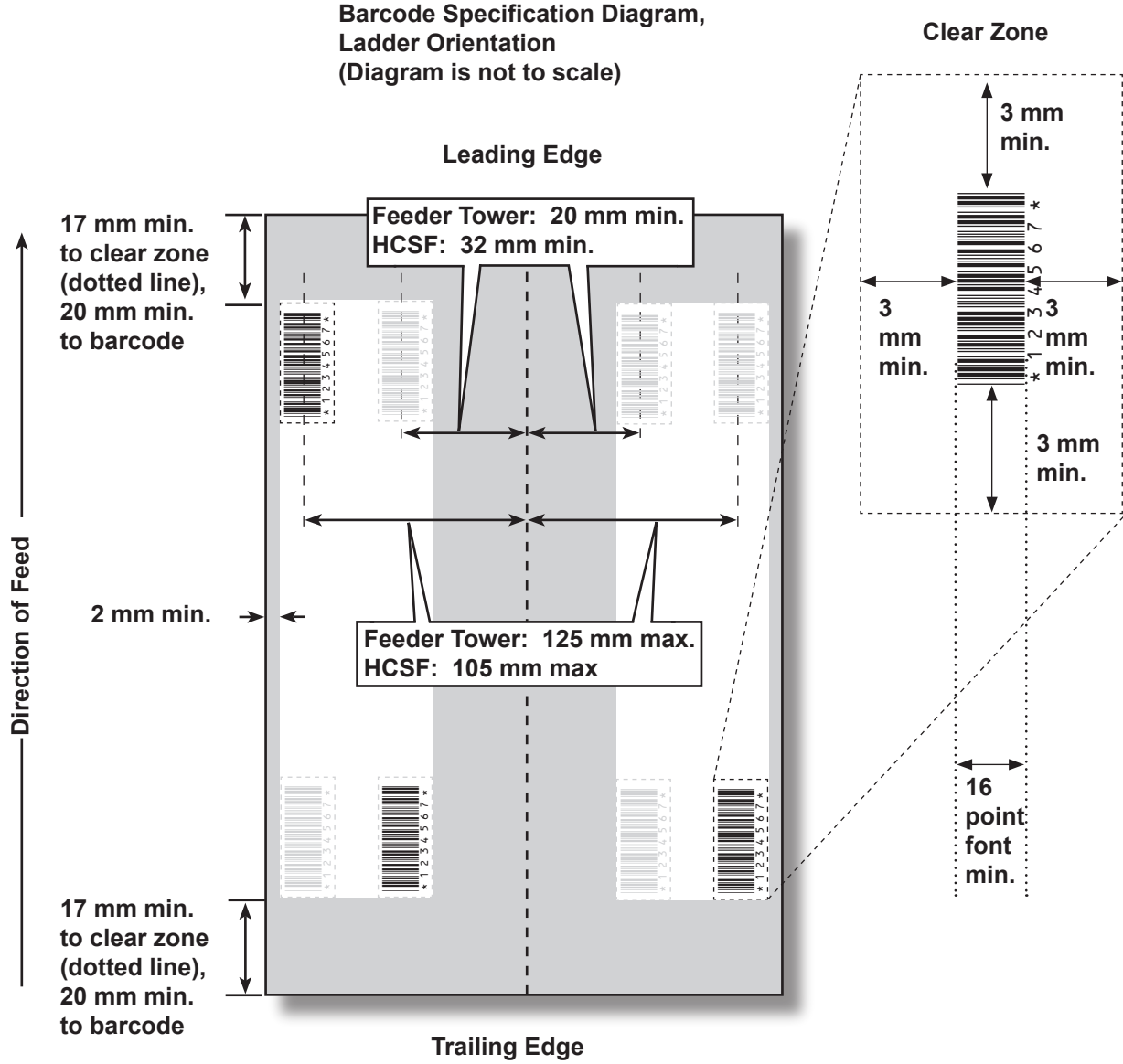

Barcode Specifications
(continued)

Barcode Specification Diagram,
Picket Fence Orientation
(Diagram is not to scale)

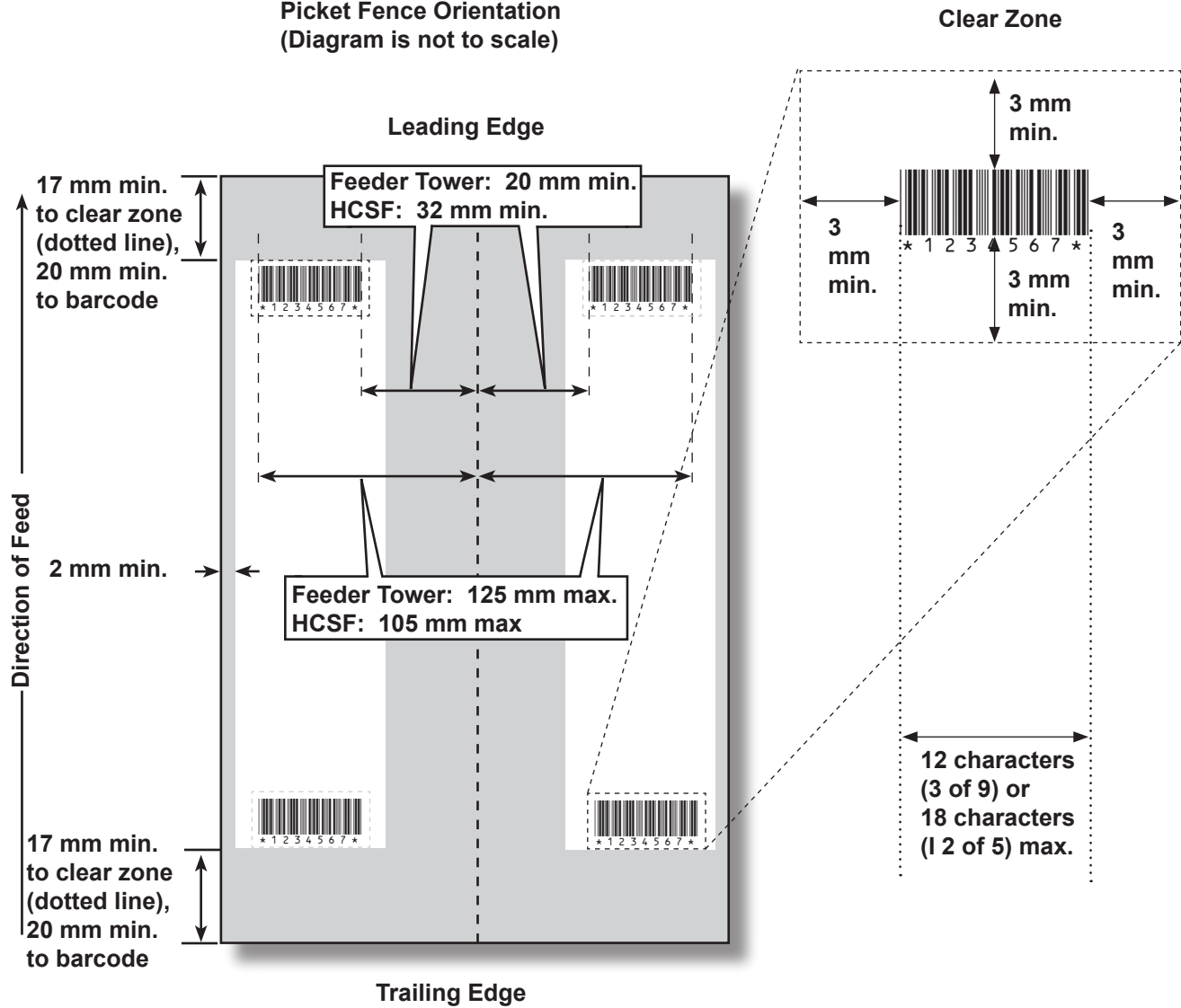

Setting the OMR Scanning Area

Material is scanned as it feeds through the machine. This means that the scanner reads a vertical strip or margin down the page, defined by the specifications.

The system must now be told if the entire margin (the strip down the page that is scanned for marks) is clear of any other printing or punched holes, etc.

- *If the area is clear*, the machine can normally detect the marks with no further setup.
- *If the entire margin is not clear, or the machine cannot set itself automatically*, it will ask questions to ascertain where it needs to look for marks and where it should ignore other printed matter. Depending on the type of code being used, the machine will ask you to define either the first mark position and code length *OR* the Clear Zone as described on the following pages.

Defining the First Mark Position and Code Length

1. Take a sheet that has at least the FIRST and LAST mark printed on it.
2. When requested by the machine, measure and enter the distance (A) from the top edge of the sheet to the FIRST mark, in millimeters.
3. When requested by the machine, measure and enter the distance (B) from the FIRST mark to the LAST mark, in millimeters.

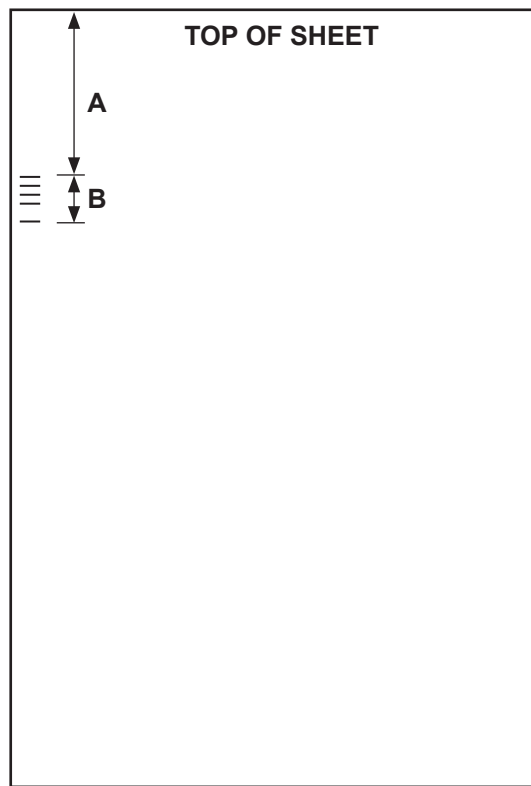

Defining the Clear Zone

1. When requested by the machine, measure and enter the distance (A) from the top edge of the sheet to the point after the printed matter where you wish the machine to START scanning.
2. When requested by the machine, measure and enter the distance (B) from the start point just set, to the point you wish the machine to STOP scanning. This is called the Clear Zone.

NOTES:

- Setting the Clear Zone closer to the beginning and end of the OMR marks decreases the possibility of any poor print or imperfections on the material being interpreted as marks.
 - Conversely, setting the Clear Zone too close to the beginning and end of the marks could cause problems if the position (registration) of the printing on the material varies.
 - A good guide is to limit the Clear Zone, but always allow at least 3/8" (9 mm) before and after the marks.
-

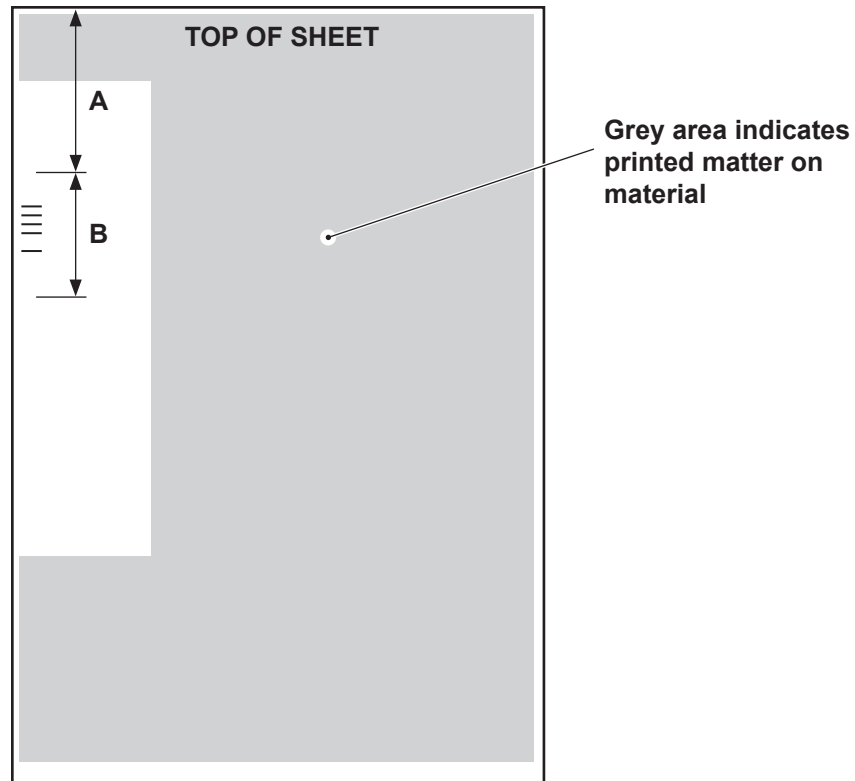

Additional Information

- Paper weight range for OMR is 18 lb. (75 gsm) to 32 lb. (120 gsm).
- Feeder linking will only work correctly if the operator has started with the correct sheet (i.e. linking can only be done reliably on a collation break). The feed order and print order will determine if feeder linking is possible. Some sort of collation integrity (WAS or MC) to ensure right pieces are in the right collations.
- Selective feed of additional sheets is always available up to the maximum limits of either folder (8 sheets of 80 gsm paper or equivalent) or 25 sheets into a flat envelope.
- For PC Controlling setup and operation, refer to the help system provided with your SureTrac™ Process Verification software.

BCR and OMR Mark Levels

This section gives brief descriptions of the available BCR and/or OMR marks. There are three levels of scanning. Each level contains specific marks.

Basic Level	Enhanced Integrity Level	Selective Operations Level
Beginning of Collation (BOC)	Wrap Around Sequence (WAS)	Select Feed (SF)
End of Collation (EOC)	Match Code (MC)	Env Select (ES)
Benchmark (BM)	Page Count (PC)	Select Next (SN)
Checksum (CS)	Page Number (PN)	Seal (SL)
Parity (PAR)		Divert Sheets (DVS)
Safety (SAF)		
Ignore (IGN)		
Timing (TM)		
Divert Finished (DVF)		
Stop (ST)		

NOTE: You may or may not have all of these marks available to you, depending upon the level(s) of OMR scanning you have purchased. However, if barcode scanning is enabled, all of these options will be available.

The "About My Machine" screen shows the level of scanning that has been enabled on your system. Follow the steps below to navigate to the screen:

1. From the Home screen, select "Menu", then "Tools".
2. Select "About My Machine".

One of the following marks *must* be present and *must* be marked as "Is controlling" in the system: EOC, BOC, PC, or MC.

- EOC is most frequently marked as "Is controlling".
- Additional restrictions apply to BOC and MC when marked as "Is Controlling".

8 • Scanning

Basic Level

The Basic level of scanning contains marks that control and check for errors within a collation.

The following marks perform basic control functions indicating the beginning, end, and how to control a collation.

Mark	Purpose
BOC - Beginning of Collation	<p>This mark indicates that it is the first sheet to be fed within a set. It may only be <i>selected once within the code</i>.</p> <p>NOTES:</p> <ul style="list-style-type: none">• When the BOC mark is used in conjunction with HCSF(s), it can be the controlling mark. In this case, the scan configuration should indicate "Content in Line with Marks" be set to "Yes" to enable the functionality. Additionally, the HCSF furthest upstream <i>must</i> be used.• Currently, if the BOC mark is controlling, the "Content in Line with Marks" option must be set to "Yes" and the mark locations settings must be entered into the system.
EOC - End of Collation	<p>This normal controlling mark indicates that it is the last sheet within the set to be fed. It is placed on every sheet <i>except</i> for the last sheet in a set (absent), or <i>only</i> on the last sheet in a set (present).</p> <p>NOTE: The absent option is preferred because it reduces the chance that a scanning error will cause two Mail Pieces to be combined into one envelope.</p>

**Basic Level
(continued)**

The following marks set up a readable code and provide basic collation integrity.

Mark	Purpose
BM - Benchmark (OMR Only)	This is a mandatory mark within multi-mark OMR codes to indicate the starting point of the code. It verifies that the scanner is working properly, and it helps detect printing problems. This mark must be either the first or last mark of the code and will appear in the same location on every page within the set.
CS - Checksum (BCR Only)	This mark is used within Code 3 of 9 and Interleaved 2 of 5 barcodes to ensure the scanner is reading the entire code properly.
PAR - Parity (OMR Only)	This mark is used to verify the internal read integrity for OMR codes. If there is an error reading the OMR code, and the scan head missed marks or saw extra marks, then Parity should catch the error. Additionally, adding a Parity mark can catch paper orientation errors. <ul style="list-style-type: none"> • If there is an even number of marks, Parity should be set to <i>even</i>. • If there is an odd number of marks, Parity should be set to <i>odd</i>. <p><i>No more than one Parity mark can be used within the code.</i></p>
SAF - Safety (OMR Only)	This mark improves the integrity of your Mail Piece. It should be at the end of the code that is opposite to the Benchmark. <p>When the Safety mark is added, the machine will automatically work out the length of the code. This makes creating jobs using this code easier. Otherwise, the machine will ask for a code length when creating a job.</p> <p><i>This mark cannot appear more than once within the code.</i></p> <p>NOTE: If a legacy code has more than one Safety mark, you can put an Ignore mark in its place.</p>

The following marks control functions for finished Mail Pieces.

Mark	Purpose
DVF - Divert Finished	This mark indicates a specific Mail Piece should be ejected unsealed into the outsort location. It is used to ensure sampling accuracy in a matched mailing, stop to ZIP breaks in presorted mailings, or eject Mail Pieces that require additional special handling. This mark must appear on every page of a set that is marked for ejection. Options available: <ul style="list-style-type: none"> • Use when: Present or Absent.
ST - Stop	This mark is a processing feature, which tells the machine to finish the piece that is being processed and stop.

8 • Scanning

Basic Level (continued)

The following marks allow the system to read legacy or competitive OMR codes.

Mark	Purpose
IGN(n) - Ignore (OMR Only)	This mark allows the system to ignore marks it does not support.
TM - Timing (OMR Only)	This mark is needed by some machines to read OMR marks correctly. This system does NOT need Timing marks, but the mark(s) may be left within an existing code and will add integrity to your Mail Piece. Timing mark(s) <i>may appear more than once within the code</i> and, if used, must always be <i>present</i> within the code.

Enhanced Integrity Level

The Enhanced Integrity level of scanning contains marks that increase collation integrity.

Mark	Purpose
MC - Match Codes	This mark is used to keep documents from one collation together and exclude documents from other collations. It increments/decrements per Mail Piece, not per item. When using SureTrac™ Process Verification software, Match Codes is required to identify the Mail Piece. OMR Marks: Up to 17 Match Code marks can be within the code. BCR Marks: The maximum number of bits for barcodes is 32.
PC - Page Count	This mark is used in two different ways: to indicate the total number of pages in a collation, or to schedule a quantity to items be fed from a specific feeder. The page count will be the same on each sheet of the set. NOTE: The Page Count and Page Number marks can be used together to ensure internal collation integrity. For example, if the Page Count and Page Number do not match, the system will recognize that an error has occurred.
PN - Page Number	This mark indicates the page number within a collation. The system checks the order of pages, and for missing or extra pages within the collation. NOTE: The Page Count and Page Number marks can be used together to ensure internal collation integrity.
WAS - Wrap Around Sequence	This is a numbering system, which uses a sequential binary coding. If a page becomes missing or the set becomes out of sequential order, the system will stop processing and declare an error message. Use to keep the entire mailing in the correct order. Ensures integrity collation to collation. OMR Marks: Up to 17 Wrap Around Sequence marks can be within the code. BCR Marks: The maximum number of bits for barcodes is 32.

Selective Operations Level

The Selective Operations level of scanning contains marks that provide special feeding instructions.

Mark	Purpose
DVS - Divert Sheets	When present, this mark indicates that the accumulation in the Pre-fold Accumulator should be diverted into the divert bin without folding or completing assembly.
ES - Envelope Select	When present, this mark indicates that dynamic envelope selection should occur.
SL - Seal	<p>This mark indicates the system should seal a Mail Piece. It does not effect where the Mail Piece exits the system.</p> <p>Seal marks can be either present or absent.</p> <ul style="list-style-type: none"> • If Seal is set to <i>present</i>, and the Seal mark is on an item, then the Mail Piece will be sealed. An item that doesn't have the Seal mark will not be sealed. • If Seal is set to <i>absent</i>, and the Seal mark is on an item, the Mail Piece will not be sealed. An item that doesn't have the Seal mark will be sealed. <p>TIP: This mark is useful when materials need to be hand-stuffed into an envelope.</p>
SF(n) - Select Feed	<p>These marks instruct the machine to select material from specific feeders. Up to nine Select Feed marks can be within the code.</p> <p>Only one item in a job can contain select feed information; this item must be the first item scanned in the job.</p> <p>All sheets or inserts for a single collation must be marked with the same select feed pattern.</p> <p>Select Feed marks can be either present or absent.</p>
SN(n) - Select Next	<p>This mark functions similar to Select Feed, but applies to the next Mail Piece in the job. This is provided for compatibility with older SECAP™ inserters.</p> <p>Select Next marks can be either present or absent.</p>

This page is intentionally blank.

Appendix A • Glossary



Basic Terms	A-2
Material References	A-2
Machine Functions	A-3
Icon Glossary.....	A-4
Envelope Icons	A-4
Fold Icons	A-5
Sheet Icons.....	A-5
Insert Icons	A-6
Feeder Assignment Icons	A-7
Other Icons	A-7

Basic Terms

The following table lists and defines standard terms used in the system's screens and this Operator Guide.

Material References

Additional Sheet - Additional sheet(s) can be added to the Mail Piece. Each will be placed into the envelope behind the Control Document.

Control Document - This sheet normally contains the destination address. This sheet will be positioned closest to the envelope window, or to the front face of a windowless envelope.

Relates to:

- OMR and Barcode use, and
- Addressed piece on non-OMR jobs.

Fan - The process of flicking through a stack of material to separate the items prior to loading.

Feeder - Object that material is loaded into to be pulled into the folder/insert for processing.

Fold Types - The folder offers these options:

- *C Fold* - Also known as "standard" fold.
- *Z Fold* - Also known as "accordion" fold.
- *Single Fold* - One fold applied (usually folded in half).
- *Double Fold* - Folded in half and then in half again.
- *No Fold* - No fold present.

Insert - An item that doesn't require folding before being placed into an envelope. There are five kinds of inserts:

- *Reply Envelope* - An envelope placed into the Outer Envelope with the other Mail Piece contents
- *Booklet* - An item with a stapled and folded binding edge.
- *Slip* - A single thickness piece of paper or card. Double detect is turned ON by default for this item.
- *Reply Card* - A single thickness piece of paper. Double detect is turned OFF by default for this item.
- *Pre-Folded Insert* - A sheet that has been folded prior to loading and requires no further folding by the machine.

Mail Piece - A single assembled article of mail, usually an envelope and its correctly ordered contents.

Manual Feed - Stapled or unstapled sets of sheets that are fed by hand.

Outer Envelope - The envelope which contains all the items placed into it by the machine.

Print Order - Refers to:

- Sheets that have been printed in a collated sequence, (i.e., page 1, page 2, page 3; page 1, page 2, page 3; etc.), *or*
- Single sheets printed in a predefined mail order.

**Basic Terms
(continued)**

Sheet - A single piece of paper that will require folding by the machine before it is placed into an envelope. In the Mail Piece Icon Tree, the sheet icon represents a stack of single sheets, or a stack of pre-collated sets of sheets.

Shingle - The method of loading inserts into a Feeder in a partially overlapped manner, like tiles on a roof.

Stack - A pile of paper as received from the printer. A Stack might consist of numerous individual Sheets or numerous Pre-collated Sets.

Tray - A removable holder of items. For example, sheets or inserts.

Machine Functions

Barcode - A printed code used to convey information to the system through optical scanning of the document.

Double Detect - Detects the incorrect feeding of a single sheet or insert. The system detects if it feeds two or more sheets when only one should have been fed.

Home Screen - The initial screen displayed after turning power on. From this screen, you can run the machine, select a pre-programmed Job, and enter the menu functions.

Mail Piece Icon Tree - A graphic that runs down the left side of the display and contains icons/small pictures that represent the items that make up the currently selected mail piece. It also indicates the location of the feeder where each item needs to be placed.

OMR Marks - The lines on the Sheets/Inserts corresponding to the system control commands. OMR marks ensure that Sheets/Inserts that belong together in a mail piece stay together as they make their way through the paper path and into the outer envelope.

Personalized - Refers to the top sheet that contains the address that will show the in the windowed envelope and/or a sheet or insert that contains unique information.

Trial Piece(s) - Test piece(s) run by the machine before automatic operation can be started. Trial Piece(s) allow the machine to calibrate itself and the Mail Piece make-up to be checked. Trial Piece(s) that do not go into the stacker are not counted.

Icon Glossary

The tables in this section provide descriptions of the various icons you will see on the display screen.

Light grey lines within an icon represent features that you cannot see. (For example, the flap on the reverse side of an envelope.)

Dark lines within an icon represent features you can plainly see.

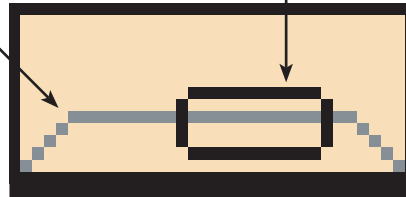

Where applicable, the darkest edge of an icon is the edge that feeds first into the system.





Envelope Icons

	Tower Feeder Orientation: <i>flap side down, flap first.</i>	HCEF* Orientation: <i>flap side down, flap last.</i>
Non-Window Letter Envelope		
Window Standard Flap Envelope		
Window Forward Flap Letter Envelope		
Window Bottom Flap Letter Envelope		
Non-Window Flat Envelope		N/A
Window Standard Flap Flat Envelope		N/A
Window Forward Flap Flat Envelope		N/A
Window Bottom Flap Flat Envelope		N/A































*High Capacity Envelope Feeder

Icon Glossary
(continued)

Fold Icons



















				
No Fold	C Fold	Z Fold	Single Fold	Double Fold



Sheet Icons



	Orientation: <i>face up, top first.</i>	Orientation: <i>face up, bottom first.</i>	Orientation: <i>face down, top first.</i>	Orientation: <i>face down, bottom first.</i>
Sheet, Not Personalized				
Sheet, Top Address				
Sheet, Middle Address				
Sheet, Bottom Address				
Multiple Sheets, Not Personalized				
Multiple Sheets, Top Address				
Multiple Sheets, Middle Address				
Multiple Sheets, Bottom Address				

Icon Glossary (continued)

Insert Icons

	Orientation: <i>face up, top first.</i>	Orientation: <i>face up, bottom first.</i>	Orientation: <i>face down, top first.</i>	Orientation: <i>face down, bottom first.</i>
Slip or Generic Insert				
Reply Envelope		N/A	N/A	N/A
Reply Card				
Multiple Slips or Generic Inserts				
Multiple Reply Envelopes		N/A	N/A	N/A
Multiple Reply Cards				



	Orientation: <i>closed edge first.</i>
Pre-Folded Insert	
Multiple Pre-Folded Inserts	

	Orientation: <i>bound edge first.</i>
Letter Booklet	
Multiple Letter Booklets	

**Icon Glossary
(continued)**

Feeder Assignment Icons





Feeder assignment is indicated by a letter in a grey square to the right of the job item icon in the Mail Piece Icon Tree. The letter that appears in the blue square will vary, depending upon the assigned feeder.

- **Single Feeder Assignment** is indicated by one grey square. 
- **Linked Feeder Assignment** is indicated by two grey squares. 

NOTE: The table below provides a list of all possible Feeder assignments. The Feeders available to you will vary, depending upon your system configuration.

Feeder Letter	Location	Position
A	Feeder Tower	Bottom left feeder
B	Feeder Tower	Bottom right feeder
C	Feeder Tower	Top left feeder
D	Feeder Tower	Top right feeder
G	High Capacity Envelope Feeder (HCEF)	N/A
J	High Capacity Sheet Feeder 1 (HCSF)	Bottom feeder
K	High Capacity Sheet Feeder 1 (HCSF)	Top feeder
L	High Capacity Sheet Feeder 2 (HCSF)	Bottom feeder
M	High Capacity Sheet Feeder 2 (HCSF)	Top feeder
X	Custom Feeder	N/A
Z	Attached Printer	N/A

Other Icons

<p>Error Icon - appears in pop-up messages on display screen. Indicates message is an error message.</p>	
<p>Warning Icon - appears in pop-up messages on display screen. Indicates message is a warning message.</p>	
<p>Seal On Icon - appears in Mail Piece Icon Tree if sealing is on. Safe Seal Icon - appears in Mail Piece Icon Tree if safe seal is on.</p>	
<p>Double Detect Icon - appears in Mail Piece Icon Tree if double detect is on.</p>	

This page is intentionally left blank.

Index



Index

A

- Access Rights 2-20, 2-21
 - manager 2-20
 - operator 2-20
 - restricted mode 2-20
 - secure mode 2-20
 - supervisor 2-20
- Add-On Modules 2-24, 7-2
- Adding
 - items 3-41
 - jobs 3-26, 3-27, 3-28, 3-29
- Adjusting
 - envelope openers 3-18, 3-19, 3-20, 3-21
 - HCEF separator gap 3-16
 - HCEF side guides 3-13
 - HCEF wedge 3-14
 - scan head 8-19
 - screen brightness and contrast 5-2
- Aligner Custom Settings 5-11, 5-12
- Alphanumeric Matrix 4-2, 8-6, 8-9
- Assigning User IDs and Passwords 4-5
- Attached Printer 1-5, 6-6
 - setting up a job with 3-33
- Attaching Trays to Feeder Tower 3-6

B

- Barcode A-3
 - scanning capability 6-5
- Barcode Print and Placement Specifications 8-26, 8-27, 8-28
- Batch Counter
 - resetting 2-12
 - setting 3-29
- Batch Mode 3-29
- BCR (Barcode) Scanning
 - Code 3 of 9 8-3
 - copying a scan configuration 8-15
 - deleting a scan configuration 8-15
 - editing a scan configuration 8-14
 - Interleaved 2 of 5 8-3
 - reviewing a scan configuration 8-16
 - setting up a scan configuration 8-9
- BCR Marks
 - beginning of collation 8-35
 - checksum 8-33, 8-35
 - divert finished 8-33
 - end of collation 8-32
 - envelope select 8-33
 - match code 8-34
 - page count 8-34
 - page number 8-34

- seal 8-35
- select next 8-35
- stop 8-33
- wrap around sequence 8-34

Belt Stacker 1-5, 7-18

Booklet A-2

C

- C Fold 2-9, A-2, A-5
 - and address/envelope combinations 6-5
- Change Language 5-4
- Changing Collation Order 3-43
- Clear Deck
 - key 2-13
- Clearing a Stoppage 5-5
- Clear Zone 3-35, 3-38, 8-18, 8-24, 8-26
- Contact Information v
- Control Document A-2
- Control Panel 2-3, 2-10
- Covers 2-22
 - closing 2-23
 - locations 2-22
 - opening 2-23
- Creating a Job 3-26–3-29
- Custom Jobs 3-5

D

- Deleting
 - items 3-44
 - jobs 4-4
- Divert Sheet Functionality 8-5, 8-18
- DM800i™, DM1000™
 - mail machine interface 3-29, 7-15
- Document Inverter 1-5
- Double Detect 2-15, A-3, A-7
 - and inserts 3-37
 - and trial pieces 2-13
 - setting for envelopes 3-31
 - setting for sheets 3-34
- Double Fold 2-9, A-2, A-5
 - and address/envelope combinations 6-5
- Drop Stacker 6-4
- Dynamic Envelope Selection 3-27, 8-4, 8-18
 - using an OMR mark 8-35

E

- Editing a Job 3-39–3-44
 - envelope options 3-30–3-32
 - fold options 3-32
 - insert options 3-36–3-38
 - saving 4-3
 - sheet options 3-33–3-35

Editing an Item 3-40
Envelope
 icons A-4
Envelope Edge Marker 7-8
Envelope Options 3-30–3-32
 depth 3-30
 enabling feeder linking 3-31
 name 3-30
 seal 3-30
 selecting feeder type 3-31
 setting double detect 3-31
 setting select feed 3-32
 size 3-30
 type 3-30
 window 3-30
Envelope Sealer 2-2
Error
 icon A-7
 messages 5-7
Exit Transport 1-5, 7-18

F

Fan A-2
Feeder
 assignment icons A-7
 linking 2-15, A-7
Feeder Linking 2-17, 6-4
 and envelopes 3-31
 and inserts 3-37
 and sheets 3-34
Feeder Setup Demo 3-10, 3-11, 3-13
Feeders Setup Demo 7-10
Feeder Tower 1-3, 2-4
 scan head adjustment 8-20
Feeder Trays 1-3, 2-5
 insert 2-6
 sheet 2-5
Fixed Function Keys 2-10, 2-11
 cancel 2-12
 help 2-12
 home 2-12
 reset counters 2-11
Flats Sealer 1-5, 3-30, 7-7
Fold
 icons A-5
 types 6-4, A-2
 and address/envelope combinations 6-5
Folder 2-3
 description 2-9
 location 2-8
 specifications 6-4
Folder Bypass Path 2-9

Fold Options 3-32
 fold length 3-32
 fold type 3-32
 setting auto fold length 3-32
Function Keys 2-13
Furniture 1-5

H

Handling Outsorts 5-6
High Capacity Envelope Feeder (HCEF) 1-3,
 2-3, A-7
 adjusting the separator gap 3-16
 adjusting the side guides 3-13
 adjusting the tail prop 3-14
 specifications 6-5
 troubleshooting 5-13
High Capacity Sheet Feeder 1-5
High Capacity Sheet Feeder (HCSF) 1-3, 7-2,
 A-7
 scan head adjustment 8-20
 specifications 6-4
Home Screen A-3
Hyperlinks 1-2

I

Insertion Area 2-3
 location 2-8
 troubleshooting 5-11
Insert Options 3-36–3-38
 enabling feeder linking 3-37
 length 3-36
 name 3-36
 page order 3-36
 personalization 3-36
 quantity 3-36
 scan item 3-37
 scan settings 3-38
 selecting a feeder type 3-37
 setting double detect 3-37
 setting select feed 3-38
 type 3-36
Inserts A-2
 adding 3-41
 icons A-6
 specifications 6-10
Insert Trays 2-6
 adjusting side guides 3-9
 loading 3-11
 setup demo 3-11
Inverter 2-9

Index

J

- Job Comments 3-29
- Jobs
 - assigning a scan configuration to 8-17
 - deleting 4-4
 - editing 3-39
 - modifying settings 3-40
 - options 3-30
 - overview 3-4
 - saving 4-3
 - selecting 3-5

K

- Knobs/Levers 2-24

L

- Large Booklet
 - adding 3-41
- LED Status Indicator 2-10
- Library Jobs 3-5, 4-4
- Loading the High Capacity Envelope Feeder (HCEF) 3-13
 - adjusting side guides 3-13
 - adjusting the separator gap 3-16
 - adjusting the tail prop 3-14
- Loading the High Capacity Sheet Feeder (HCSF) 7-3, 7-4
- Loading Trays 3-8
 - adjusting side guides 3-9
 - overview 3-8
 - sheet tray 3-10
- Location screen 3-41
- Logging In 2-21
- Logging Out 2-21
- Login Not Required Mode 2-20, 2-21
- Login Required Mode 2-20
- Lower Divert Area 8-5

M

- Machine Action Keys 2-10, 2-13
 - clear deck 2-13
 - start 2-13
 - stop 2-13
 - trial piece 2-13
- Mail Machine Interface 1-5, 3-29
- Mail Piece A-2
- Mail Piece Icon Tree 2-15, 2-17, A-3, A-7
- Mail Piece Path 2-8
- Mail Piece Problems

- troubleshooting 5-14
- Maintenance 5-16
- Manager Access Rights 2-20
- Manual Feed A-2
- Manual Feeder 2-3, 2-7
- Material Safety Data Sheets v
- Material Specifications
 - Feeder Tower 6-7
 - envelopes 6-7–6-8
 - inserts 6-10
 - sheets 6-11
 - HCSF 6-12
 - sheets 6-12
- Moistener, Closer, Sealer
 - capacity 6-4
 - description 2-9
 - location 2-8
- Moving an Item 3-43

N

- No Fold 2-9, A-2, A-5

O

- OMR Marks A-3
 - beginning of collation 8-32, 8-35
 - benchmark 8-33
 - divert finished 8-33
 - divert sheets 8-35
 - end of collation 8-32
 - envelope select 8-35
 - ignore 8-34
 - match code 8-34
 - page count 8-34
 - parity 8-33
 - safety 8-33
 - seal 8-35
 - select feed 8-35
 - select next 8-35
 - stop 8-33
 - timing 8-34
 - wrap around sequence 8-34
- OMR Scanning 8-2
 - adjusting the scan head 8-19
 - copying a scan configuration 8-15
 - deleting a scan configuration 8-15
 - editing a scan configuration 8-13
 - reviewing a scan configuration 8-16

setting up a scan configuration 8-6

OMR Specifications

clear zone 8-30

code length 8-29

first mark position 8-29

scanning area 8-29

sheets and folds 8-31

OMR Specifications

8-24

ON/OFF switch 3-2

Operator Access Rights 2-20

OptiFlow™ Vertical Power Stacker 1-5

Optiflow™ Vertical Power Stacker 7-18

Option Keys 1-8

Ordering Supplies v

Outer Envelope A-2

P

Paper Release Knobs 2-24

Paper Stoppages

Clearing a Stoppage 5-5

Personalized A-3

Piece Counter

resetting 2-11

Post-fold Accumulator 2-3, 2-9

location 2-8

Powering Up 3-2

Power Stacker 6-4

Pre-fold Accumulator 2-3, 2-8

location 2-8

Pre-Folded Insert A-2

Pre-Run Adjustments 3-18

adjusting the envelope openers 3-18

adjusting the HCSF guides 7-5

adjusting the printer interface guides 7-11

adjusting the scan heads (scan settings) 8-19

printing a cover sheet to the Top of the at-

attached printer 7-13

Print Order A-2

R

Recent Jobs 3-5

Relocating a Item 3-43

Removing Trays from the Feeder Tower 3-7

Renaming a Job 4-3

Replenish Sealer Fluid 5-5

Reply Card A-2

Reply Envelope A-2

Resetting

batch counter 2-12

piece counter 2-11

Resuming the Job 5-6

Running a Job 3-4

Running a Trial Piece 3-22, 3-23

S

Safe Seal 3-30

Safe Seal Icon A-7

Safety Information 1-6

Saving a Job 4-3

Scan Configuration

editing 8-13

Scan Configuration Worksheet 8-6, 8-10

Scan Head Adjustment 8-19

ladder orientation marks 8-19

picket orientation marks 8-22, 8-23

Scanning 8-2

BCR 8-2, 8-3

OMR 8-2

specifications 6-5

troubleshooting 5-15

Screen Brightness and Contrast

troubleshooting 5-7

Screen Navigation Keys 2-10, 2-13, 2-18

Screen Option Keys 2-10

Sealing Solution 2-3

Seal On Icon A-7

Security

assigning user IDs and passwords 4-5

Select the Job 3-4

Separator Gap

adjusting 3-16

Set Time and/or Date 5-3

Sheet Icons A-5

Sheet Options 3-33, 3-33–3-35

control document 3-33

enabling feeder linking 3-34

length 3-33

name 3-33

page order 3-33

personalization 3-33

quantity 3-33

selecting feeder type 3-34

setting double detect 3-34

type 3-33

Sheets A-3

adding 3-41

specifications, feeder tower 6-11

Index

- specifications, HCSF 6-12
- Sheet Trays 2-5
 - adjusting side guides 3-9
 - loading 3-10
 - setup demo 3-10
- Shingle A-3
- Side Guides
 - and scan heads, adjusting 8-19
 - HCEF, adjusting 3-13
 - tray, adjusting 3-9
- Single Feeder Assignment A-7
- Single Fold 2-9, A-2, A-5
 - and address/envelope combinations 6-5
- Sled 3-12
- Slip A-2
- Specifications
 - components 6-4
 - OMR 8-24
 - scanning 6-5
 - system 6-2
- Stack A-3
- Stacker 2-3
 - drop 6-4
 - power 6-4
- Supervisor Access Rights 2-20
- SwiftStart™ 3-3, 3-25
- System Options 1-5

T

- Tandem Belt Stacker 1-5, 7-18
- Technical Support v
- Throughput 1-3
- Transport Deck 1-3, 2-8
 - mail piece path 2-8
 - pre-fold accumulator 2-8
- Trays
 - attaching to feeder tower 3-6
 - removing from feeder tower 3-7
- Trial Piece 3-22, A-3
 - double detect 2-13
 - key 2-13
- Troubleshooting
 - folder/inverter problems 5-10
 - high capacity envelope feeder problems 5-13
 - inserter station problems 5-11
 - mail piece problems 5-14
 - moistener/exit problems 5-12
 - scanning problems 5-15

- tower vertical transport problems 5-10

U

- Upper Divert Area 8-5
- Use Postage Meter. See Mail Machine Interface
- User IDs 2-21
- Using the Alphanumeric Matrix 4-2

W

- Warning Icon A-7
- Wedge
 - adjusting 3-14

Z

- Z Fold 2-9, A-2, A-5
 - and address/envelope combinations 6-5



Engineering the flow of communication™

1 Elmcroft Road
Stamford, Connecticut 06926-0700
www.pb.com

5500 Explorer Drive
Mississauga, Ontario L4W 5C7
www.pitneybowes.ca

For Service or Supplies

PB Form SV61311 Rev. E 10/06

©2006 Pitney Bowes Inc.
All Rights Reserved
Printed in the USA or Canada

 Printed on recyclable paper



* S V 6 1 3 1 1 R E V E *